

TABLE OF CONTENTS



Safety Notices	1
Introduction	3
Testing Samples	3
Connect an Optional Printer	4
Interface To A Computer	4
Features.....	4
Specifications.....	5
Installation and Setup.....	7
Unit Positioning	7
Disengage Shipping Brace	8
Connect AC Power	9
Change Access Codes	10
Communication Ports	10
Startup and Familiarization.....	11
Startup Procedure.....	11
Display Screen.....	12
Adjust Screen Contrast.....	12
Define Keyboard Key Functions	12
Menu Screens.....	15
Alarm	15
Measure Moisture	17
Test Moisture Preparation	17
Measure Moisture (Basic Method).....	18
Grain Sample ID Numbers.....	20
Enter Numbers and Alpha Characters	20
Use ID Options	21
Use Factors (Labels)	22
View The Next Page	22
Grain Selection.....	25
Select Grain Menu	25
Quick Keys.....	26
Calibrating Procedures	27
View Calibration Data (1 Key).....	27
Enter/Change Calibration Values (2 Key).....	28
Print Calibration Grain List (3 Key)	31
Obtain Basic Calibration Data (4 Key)	31
Print Audit Memory Data (5 Key).....	33

TABLE OF CONTENTS



Establishing Parameters	37
Clear Cycle Counter (1 Key).....	37
Choose ID Options (2 Key).....	38
Configure Output Options (3 Key)	39
Change Access Code (4 Key)	42
Change Labels (6 Key).....	45
Set Communications Port Parameters (7 Key).....	48
Service Menu (8 Key)	55
Quick Keys Menu	55
Test Weight Adjustment Menu	56
Test Unit Performance	59
Non-Active Keys	59
View COM1 Port (2 Key)	59
View COM2 Transmit Port (3 Key)	60
View Display Characters (5 Key).....	61
View Diagnostic Mode (6 Key)	61
Test Network Mode (7 Key).....	63
View/Print Parameters (8 Key)	65
Operator Maintenance	69
Cell Cleaning - Daily	69
Fuse Replacement	69
Error Codes.....	71
Appendix A: Communication Ports	73
COM1 Port Options	73
COM1 Pin Assignment Details	73
COM2 Pin Assignment Details	74
Appendix B: Automatic Hopper Sensing	77
Hopper Full Sensor Operation.....	77
Warranty.....	79



SAFETY NOTICES

Safety notices are one of the primary ways to call attention to potential hazards.



This Safety Alert Symbol identifies important safety messages in this manual. When you see this symbol, carefully read the message that follows. Be alert to the possibility of personal injury or death.

⚠ WARNING

Use of the word WARNING indicates a potentially hazardous situation which, if not avoided, could result in death or serious injury.

⚠ CAUTION

Use of the word CAUTION with the Safety Alert Symbol indicates a potentially hazardous situation which, if not avoided, may result in minor or moderate injury.

CAUTION

Use of the word CAUTION without the safety alert symbol indicates a potentially hazardous situation which, if not avoided, may result in equipment damage.

OPERATOR'S MANUAL





INTRODUCTION

The DICKEY-john Grain Analysis Computer GAC 2100b quickly tests grain samples for moisture content, test weight, and profile information. The unit loads a sample, weighs and checks temperature, runs the test, displays the results, and then unloads the sample. The test results calculate automatically to display the moisture content and, if enabled, the temperature and test weight (density) or approximate test weight (dependent on grain calibration type) of the grain sample. Also, the product name, grain calibration date and sample ID number display for identification. An additional screen of information includes readings for the conductance (D1), capacitance (D2), weight (D3) and temperature (D4) values along with the currently set date and time.

Figure 1
GAC2100b Unit



TESTING SAMPLES

Performing a grain sample analysis consists of six basic steps:

1. Select a grain for testing through keyboard entries. Up to 64 grain choices are available.
2. Pour grain sample into the hopper (top of the unit) and enter a sample ID number (optional).
3. Press the **Load** key (not required in AUTOMATIC mode). The sample automatically loads (drops) the grain into the test cell and a strike-off arm levels and removes the excess.



Load Key



Print Key



Unload Key

4. Wait approximately 15 seconds for the test results to process. The moisture reading, grain temperature, and test weight will be displayed (depending upon grain selection and machine setup).
5. Print a hard copy of the test results. With an optional printer connected, the date and time with sample identification number and all test information is printed. By pressing the **Print** key, additional copies may be printed.
6. Press the **Unload** key to empty the test cell contents. The test cell rotates 180° (inverts) to dump the grain into a sample drawer or into a larger container below the counter top. After the cell returns to the upright position, the unit is ready for the next test sample.

CONNECT AN OPTIONAL PRINTER

An optional printer may be connected to the GAC 2100 to print test data results. The printout may include the facility name and address, current date and time, sample ID number, product name, grain calibration date, percent moisture, grain temperature, unit serial number and the D1 through D4 values. The data may either automatically print at the end of each measurement cycle or be manually initiated by pressing the **Print** key.

INTERFACE TO A COMPUTER

The GAC 2100b is capable of communicating with a personal computer (PC) either directly (using a cable) or at different locations through a modem. If the GAC 2100b and the PC are at the same site, a direct connection is made by an interconnecting null modem adapter available from DICKEY-john. The computer, operated by authorized personnel, is able to control most functions within the GAC 2100b from the remote location. The GAC 2100b stores changes for later recall and auditing. This storing process becomes an audit trail (or record) to track calibration changes. The most recent 1000 changes or events are retained. Operation from the computer is described in a communications software manual.

Note: NTEP approved for test weight calibrations have an issue date that ends with an N and 99 as the first two characters of K8.

FEATURES

Major features of the GAC 2100b include:

- Memory for up to 64 different grain calibrations.
- Calculation of test weight for NTEP approved grains.
- Calculation of approximate test weight for customer-entered calibrations (grains 41-64).
- Test weight bias adjustment on all grain types with access restrictions dependent on grain calibration type.
- Keyboard entry or computer accessibility for updating grain calibrations as revisions become necessary.
- Alpha/numeric sample identification numbers with automatic sequential numbering for record keeping purposes.
- Automatic ranging by switching to predetermined calibrations when moisture is above or below normal limits.
- Two RS-232 output ports (DCE and DTE) available for printer and external computer/modem control.



- Capability to interface with a personal computer either directly or through a modem.
- Self-check mode to assure proper continual operation.
- Error messages display when out-of-limits moisture, grain weight, or grain temperature occur.
- Help screens to assist operator's questions.

Figure 2

GAC 2100b Dimensions

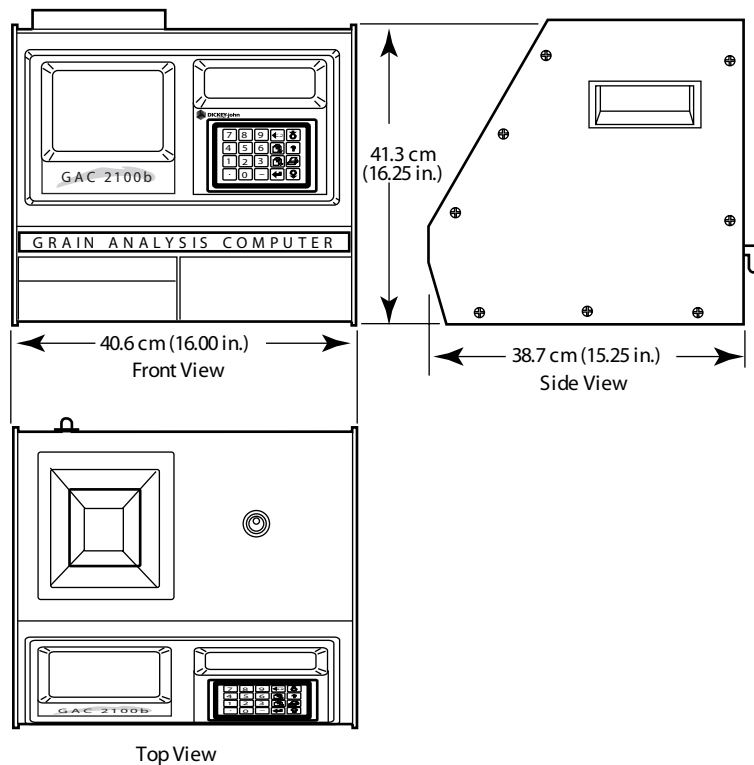

SPECIFICATIONS

- **Supply Voltage and Frequency Limits:** 100 Vac to 240 Vac 50/60 Hz at 1 Amp Max.
- **Operating Temperature Range:** 2° C (35.6° F) to 45° C (113° F). If the unit temperature range is exceeded, an ERROR message is displayed.
- **Grain Temperature Range:** 0° C (32° F) to 45° C (113° F). If the grain temperature range is exceeded, an ERROR message is displayed.
- **Unit Temperature and Grain Temperature Difference Limit:** The maximum allowable temperature differential between empty cell and grain under test is 20° C (36° F). If exceeded, an ERROR message is displayed.
- **Classes/Types of Grain or Seed:** refer to the latest Calibration Bulletin.
- **Weight:** 12.2 kg (27 lbs) – **Shipping Weight:** 15.4 kg (34 lbs)

OPERATOR'S MANUAL





INSTALLATION AND SETUP

Before shipping, the GAC 2100b is inspected and tested for mechanical and electrical defects. After unpacking, visually inspect for damage occurring during transit. Save all packing materials until the inspection is complete. If damage is found, immediately file a claim with the carrier and notify your DICKEY-john Sales Representative.

UNIT POSITIONING

Choose a clean environment for the GAC 2100b that is protected from rapid changes in ambient temperature. Avoid a hazardous (classified) location as defined in Article 500 of the NFPA Handbook of the National Electrical Code.

Use the self-contained level on the panel top to position the GAC 2100b on a flat level or nearly level surface. Adjust the four rubber foot pads to level and stabilize the unit (refer to Figure 3). When moving the unit to a different location, re-leveling may be necessary. After adjustment is complete, all four leveling foot pads should be set to the lowest level possible with one pad fully seated against the bottom panel. This assures minimum height above the counter top.

Figure 3

Leveling With Rubber Foot Pads

1. Use wrench to loosen the upper nut and then adjust height.
2. Ensure bottom nut is locked down against rubber foot pad.
3. Use a Phillips screwdriver in center of pad to change height and to hold the screw from turning while tightening nuts.
4. After adjustment, retighten nut up against bottom panel.

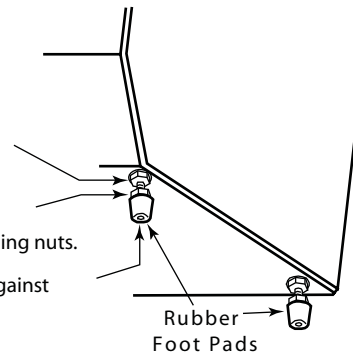

To adjust the foot pad height, unlock the upper nut from the bottom panel of the selected foot pad. Then, adjust the height as required.

After adjusting, use a Phillips screwdriver in the center of the foot pad to hold the screw from turning and tighten the upper nut against the bottom panel of the unit. Ensure the lower nut remains tight against the foot pad.



DISENGAGE SHIPPING BRACE

CAUTION

The shipping brace must be moved to the operate position before applying power. Since the grain test cell cycles through an unload sequence during power up, damage may occur with the shipping brace in the transport position.

The GAC 2100 is shipped with the grain test cell supported by a internal shipping/transport brace. This brace is to support the test cell whenever the unit is transported. The position of the brace is controlled by a handle, located on the rear panel behind the grain test cell (refer to Figure 4). A small spool is placed over the handle during shipping to prevent possible bumping and releasing of the handle. Remove this spool and store as part of shipping materials. Push the handle in to unlock and rotate counterclockwise to the locked operate position as indicated on the back panel. The movement of the brace is viewable through the front window of the unit.

Figure 4

Rear View Of Unit

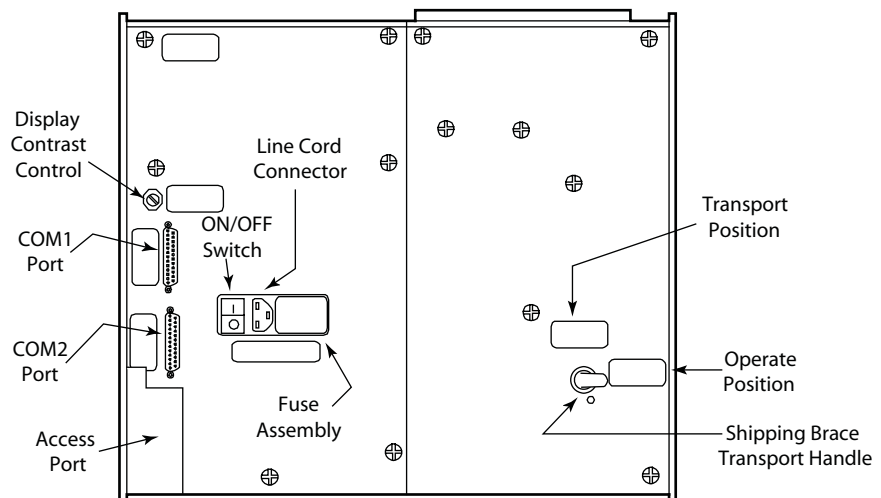

CAUTION

Rotate brace back into supporting position before moving or shipping unit. If the cell is not adequately supported, operating performance may be adversely affected due to cell bouncing. Some effort is required to move the brace into position. It may be helpful to reach inside the drawer front and lift up on the cell while attempting to lock the brace into the transport position. Place spool over handle to prevent accidental release of shipping brace.



CONNECT AC POWER

Verify that the ON/OFF (I/O) switch is in the OFF (O) position and that the shipping brace is in the OPERATE position. Plug the line cord into the connector on the rear panel next to the ON/OFF switch. Plug the male end into an appropriate 3-wire (grounded) outlet.

⚠ WARNING

The grounding pin on the line cord connects directly to the GAC 2100b frame. When using an adapter with a grounding wire, make sure the grounding wire is connected properly to a good earth ground to prevent a shock hazard.

Normal use of the sample drawer can be bypassed by removing the drawer bottom and cutting a hole into the work counter to allow the tested grain samples to fall through to a larger container below. The size of the hole must be at least equal to the drawer dimension and located directly beneath the grain sample drawer.

Remove the bottom of the grain sample drawer by carefully lifting the two plastic tabs at the front of the drawer (refer to Figure 5). Using a small screwdriver, gently pry up on each tab and slide the bottom panel out the rear of the drawer. **BE CAREFUL NOT TO BREAK THE TABS.**

Figure 5

Removing Drawer Bottom

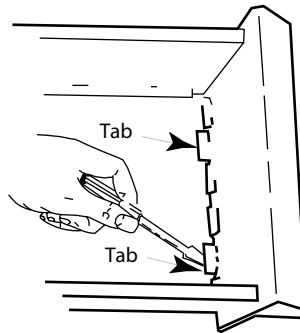

When finished, slide the grain drawer back into position. This prevents grain from spilling onto the work surface in front of the unit.

If replacing the drawer bottom later, slide the bottom toward the drawer front until it latches under the two plastic tabs.



CHANGE ACCESS CODES

A code is necessary to access certain screens. Whenever the code is required, a screen appears displaying ENTER ACCESS CODE. The factory preset access code is set to 0. If the access code requires changing for security reasons, refer to CHANGE ACCESS CODE in the ESTABLISH PARAMETERS section.

COMMUNICATION PORTS

Two communication ports located on the rear of the unit transfer data. The ports are: (a) Printer Output Port (COM1) and (b) Computer Output Port (COM2). Each must be properly configured to communicate with external devices. Port configuration is described in ESTABLISH PARAMETERS.



STARTUP AND FAMILIARIZATION

This section defines the keyboard layout, display messages, and other operator controls.

STARTUP PROCEDURE

Each time the GAC 2100b is powered, the unit performs a series of self checks to determine the status of the (1) load/strike-off mechanism, (2) unload function, (3) empty test cell weight, and (4) conductance/capacitance measurement circuitry. The self-checks begin when the hopper doors open, the strike-off arm swings across the cell and back again, and the cell dumps. When the cycle ends (about 15 seconds), the **Main** menu is displayed.

CAUTION

Before starting the following procedures, ensure the ON/OFF (I/O) switch is in the OFF (O) position and that the shipping brace is in the OPERATE position. These are both located on the rear of the unit (refer to Figure 4).

1. Turn the power switch ON. Initially, a language screen appears showing eight choices (refer to Figure 6).

Figure 6

Start Up Screens

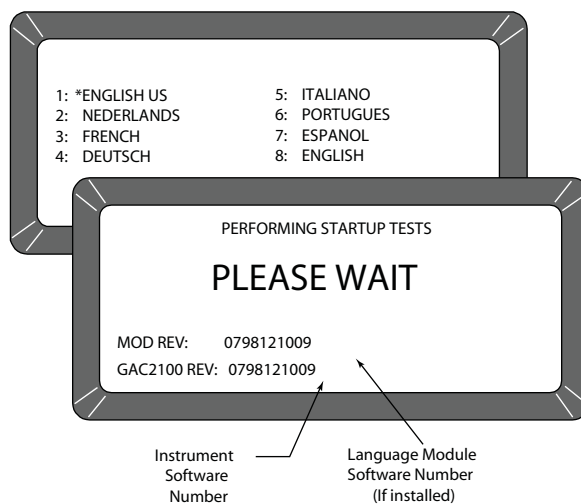

2. Select a language by pressing the key number indicated next to the desired language. This screen only remains available for approximately 8 seconds. Once selected, an asterisk will appear and will remain in front of the selection until changed again during another start-up cycle.



3. Wait for the remaining portion of the cycle to finish. A second screen will appear and display PLEASE WAIT while the unit is performing self-checks. The bottom two lines of this screen display the software revision numbers (refer to Figure 6).
4. After the **Main** menu is displayed, proceed with general operation.

DISPLAY SCREEN

The display screen is a graphics Liquid Crystal Display (LCD) and is backlighted for low light level viewing.

ADJUST SCREEN CONTRAST

The Display Contrast Control is on the rear panel (refer to Figure 4) immediately above the COM1 and COM2 ports. The contrast control changes the contrast between the displayed characters and the background. Adjust the control as necessary for a comfortable contrast level in varying light conditions.

DEFINE KEYBOARD KEY FUNCTIONS

All operator controls, except the Power ON/OFF switch and Contrast Control, are located on the front panel. These two are on the rear panel.

The sealed membrane keyboard contains 20 pressure-sensitive keys requiring light finger pressure to actuate each key. Valid key closures result in short tone bursts, while invalid keystrokes generate longer tone bursts. The function of each key or key group is defined as follows and illustrated in Figure 7.

Numbers (0 through 9), Decimal point (.) and Minus (-) Keys

All numeric keys perform dual functions, making menu selections and entering numeric values. The four numeric keys displaying small arrows have the additional function of screen navigation. When making a numeric entry, a prompt on the display identifies the value entered and a cursor shows the destination of each entry. The minus (-) sign is accepted at any point in the entry and displays at the front of the entered string.



Figure 7
Keyboard Layout

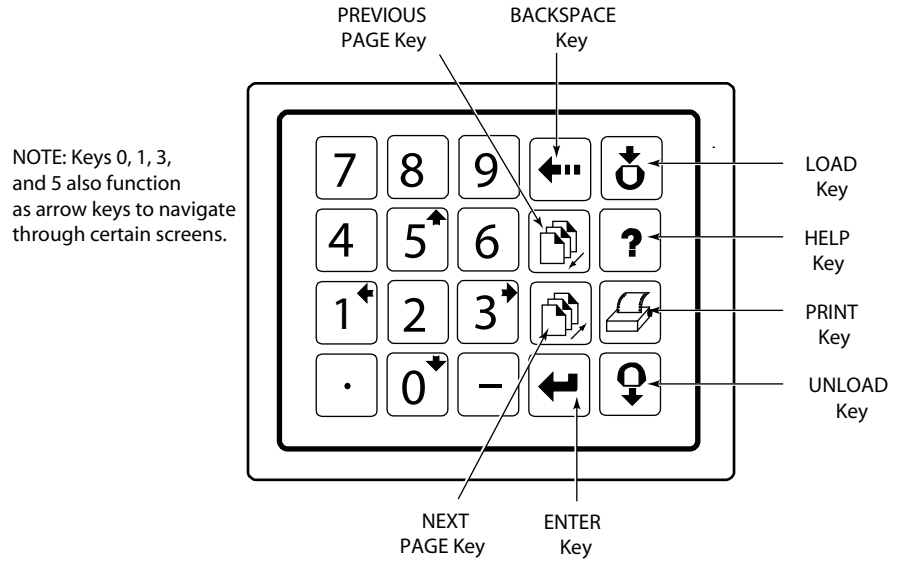

Backspace Key



Next Page Key

Each entry is immediately displayed as the cursor moves to the right in preparation for the next entry. Only the first entry of the decimal point is acknowledged.

The **Backspace** key moves the cursor to the left to delete the last keystroke or to clear an entire entry field.

The **Next Page** key advances to the next page when the <more> prompt appears in the lower right corner of the display (refer to Figure 8). The **Next Page** key sequences the display forward to additional pages of information. The total page number and page count appear in the lower left corner of screen (i.e. PAGE 2 OF 8).

Figure 8
Typical Screen Indicating More Pages

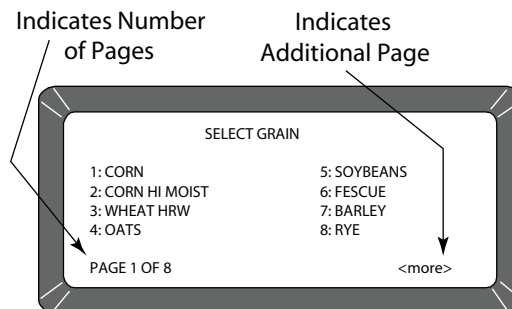



Previous Page Key



Enter Key



Load Key



Help Key



Print Key



Unload Key

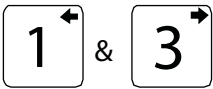

Left and Right Keys

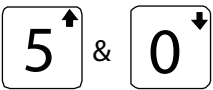

Up and Down Keys

The **Previous Page** key sequences backward through previously displayed pages. Neither the **Previous Page** or **Next Page** keys roll-over the pages to the beginning or end.

The **Enter** key accepts the character string after an entry is complete.

The **Load** key initiates a grain cell loading sequence to begin a test cycle.

The **Help** key provides context sensitive help screens display. If the <more> message appears at the lower right of the screen, additional pages are accessible with the **Next Page** key. To use the HELP INDEX when in a **Help** screen, select the 0 key and then select the desired topic. To resume normal operation, select the **Help** key a second time.

The **Print** key initiates a printout of current information on the screen (e.g., grain moisture analysis, calibrations data, etc.). If the automatic printout option is selected, the **Print** key initiates duplicate copies. Help information does not print. COM SETUP options allows the **Print** key to transmit to either the printer port or the communications/modem port. For example, the system may be configured to automatically print results through the printer port while the **Print** key transfers results to the computer port.

Once the grain test completes, pressing the **Unload** key instructs the test cell to dump its contents.

The **Left** and **Right** keys move the cursor horizontally during alpha entries and certain functions during the SETUP mode.

The **Up** and **Down** keys move the cursor vertically during alpha entries and certain functions in the SETUP mode.

Figure 9

Main Menu Selections

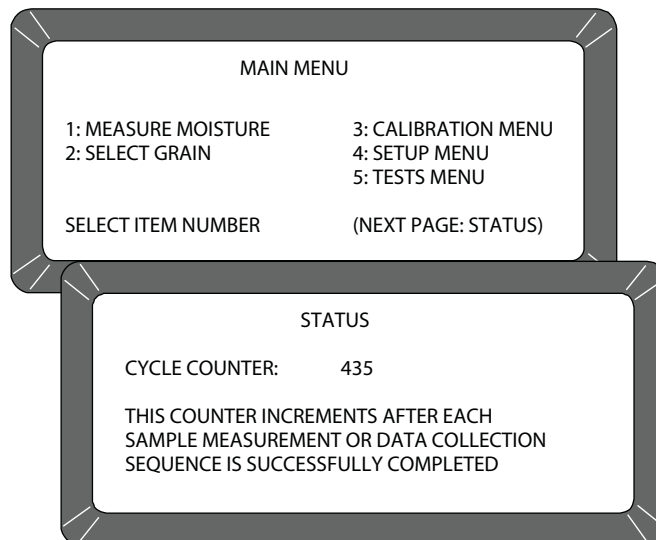



MENU SCREENS

The **Main** menu will be displayed once the start-up checks are successfully completed. The **Main** menu is the “home” screen through which all other screens are accessed. The **Main** menu displays five major selections or categories (refer to Figure 9).

A number will appear next to each **Main** menu selection. Select the desired number to access the appropriate menu. Refer to Figure 10 for a general configuration of the Menu Tree layout.

ALARM

An audible alarm is enabled for .5 seconds at the end of each grain analysis or for an error condition. A shorter beep of .1 seconds sounds for each valid key stroke.

OPERATOR'S MANUAL



Figure 10
Menu Tree

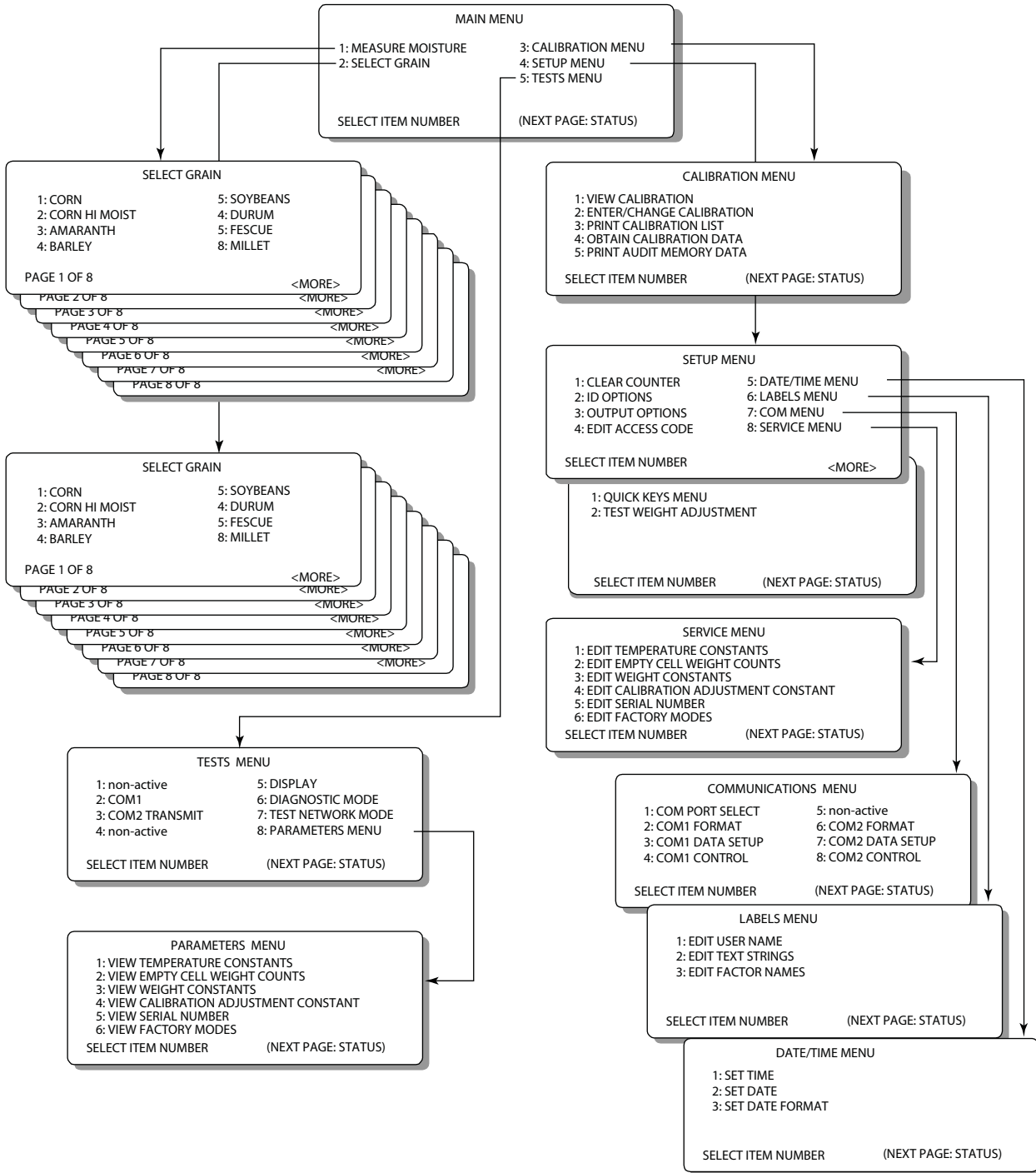



MEASURE MOISTURE

The **Main** menu appears immediately after all start-up checks have successfully concluded (refer to START-UP AND FAMILIARIZATION). The **Main** menu displays five major selections or categories. This chapter describes the MEASURE MOISTURE procedure.

TEST MOISTURE PREPARATION

To measure moisture:

1. Choose MEASURE MOISTURE (1 Key) from the **Main** menu to display the **Select Grain** menu.

Figure 11

Moisture Testing Preparation

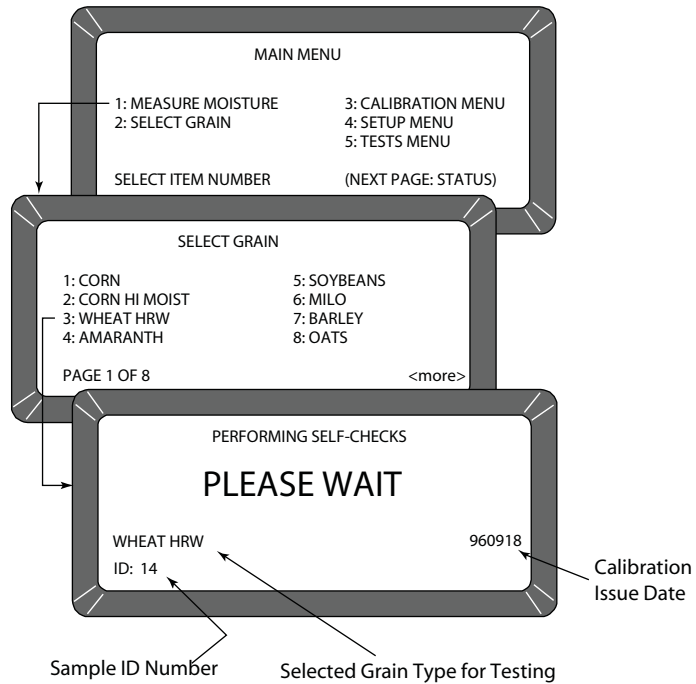

Next Page Key



Previous Page Key

2. Locate the grain type for testing and select the corresponding number to the left. If the grain to be tested is not shown on PAGE 1 OF 8, press the **Next Page** key to view PAGE 2 OF 8. This may be repeated for eight pages (up to 64 calibrations). After selecting a grain, the unit will cycle through self-check tests to ensure the program memory and calibrations are valid. Subsequent moisture measurements default to the previously selected grain.
3. If an additional measurement is desired for another grain, press the **Previous Page** key to return to the **Main** menu. Select the option SELECT GRAIN (2 key), and choose a new grain (refer to GRAIN SELECTION for additional information).



Down Arrow Key



Enter Key

4. Enter a sample ID number. This number identifies the sample tested on the paper printout. If the ENTER REQUIRED FOR ID is turned ON (refer to CHOOSING ID OPTIONS in the ESTABLISHING PARAMETERS section), the **Enter Sample Id** screen is displayed (refer to Figure 12) and an ID number is required. Other ID numbering options bypass this screen. Details on how to use ID numbers are described later in this section. Use the **Down Arrow** key (0 key) to place the cursor next to the ID and enter any number. Press the **Enter** key.

Figure 12
Screen Sequence Using Enter Required For ID

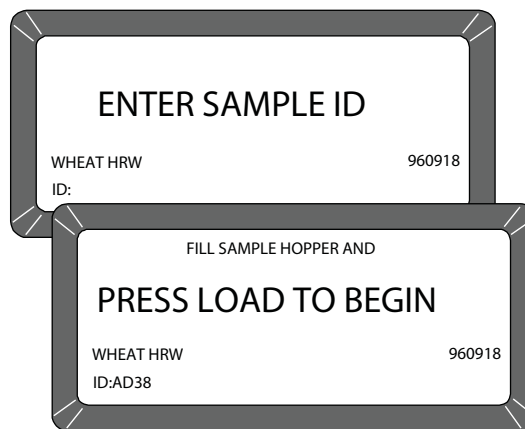

NOTE: *The optical path of the hopper sensor must be blocked when performing a measurement on a NTEP APPROVED FOR TEST WEIGHT calibration. Although not required for other calibrations, it is recommended that this level be used whenever possible. NTEP APPROVED FOR TEST WEIGHT calibrations are those that have an issue date that ends with an N and have 99 as the first two characters in the K8 constant.*



Load Key



Enter Key

MEASURE MOISTURE (BASIC METHOD)

After all calibration self-checks for the selected grain are complete (approximately 10 seconds), the message FILL SAMPLE HOPPER, ENTER ID NO. THEN...PRESS LOAD TO BEGIN will be displayed (refer to Figure 13).

To measure moisture:

1. Pour grain into the sample hopper. Fill the hopper until the grain is at least 2.54 cm (1 inch) above the optical path of the HOPPER FULL SENSOR (heap grain slightly). The exact volume is unimportant, except enough grain must be present to overfill the cell (approx 1 liter or 4 cups). Excess grain spills over the cell top and falls into the grain drawer below.
2. If the ID number has not already been entered, enter a number or skip to Step 3.
3. Press the **Load** key to begin the test cycle. If factors (a type of label) are enabled, an screen will appear displaying the message ENTER RESULTS FOR THE FOLLOWING. Disregard this screen by entering a number and pressing the **Enter** key. Refer to FACTORS for additional information.

After pressing the **Load** key, the hopper doors open and drop the grain into the test cell. The cell fills and the striker arm swings across the top to remove excess grain.



NOTE: When using an NTEP APPROVED FOR TEST WEIGHT calibration, an ERROR 14 message will be displayed if the hopper was not full when the LOAD button was depressed.

CAUTION

Caution: Do not insert fingers or other foreign objects into the opened hopper doors.

4. Wait approximately 15 seconds for the moisture test to complete (refer to Figure 13). A screen will appear displaying the message MEASURING - PLEASE WAIT.

Figure 13

Basic Moisture Measuring Cycle

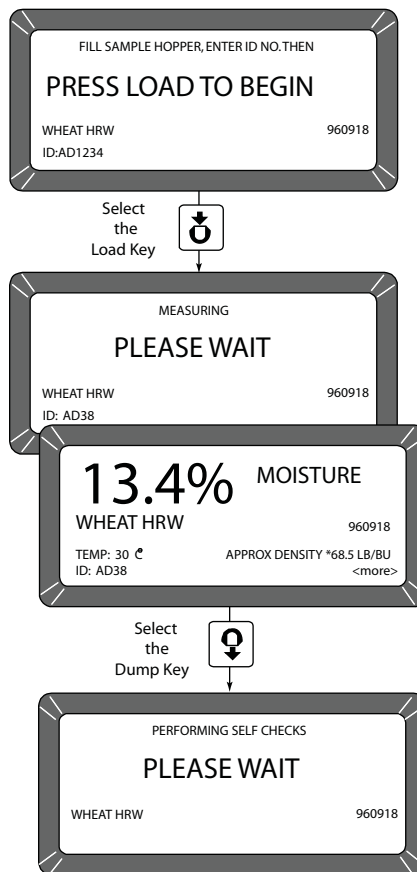



Next Page Key



Enter Key



Unload Key

5. The Grain Name and moisture percent will appear on the display, along with the sample temperature, sample ID, and grain calibration issue date.
6. The option <more> will be displayed on lower right corner of the screen. Press the **Next Page** key to view additional pages. The D1 through D4 values will be displayed, along with the present date (lower left corner) and time (lower right corner).
7. If the <more> prompt is still displayed, press the **Next Page** key again. This page is only available if FACTORS are used. FACTORS are a type of label that allows the user to enter data for additional information on the paper printout. Up to four user-defined factors (or labels) may be displayed and printed as specified on the **Setup** menu. If this screen is displayed, enter numbers as desired and press the **Enter** key. If no factor names are specified, the screen will not be displayed.
8. When the measurement is complete, press the **Unload** key. The test cell will invert, dumping the grain and returning to the upright position.
9. Start a new moisture measurement for the same grain type. The GAC 2100b remembers the grain type until it is changed or power is turned OFF. The **Select Grain** menu does not appear again until it is selected.

GRAIN SAMPLE ID NUMBERS

Three sample ID options may be selected to number grain samples; (1) **Automatic number sequencing** (e.g., 1, 2, 3...), (2) **Manual entry** (numbers may be manually entered or skipped) and (3) **ENTER REQUIRED FOR ID** (produces the **Enter Sample Id** screen) which prompts a required entry before proceeding (refer to Figure 12). The ID field may be either numeric or alphanumeric. If numeric only, the digits 0-9, the decimal point, and the minus sign are entered with the keyboard. Other characters are entered from an alpha screen.

ENTER NUMBERS AND ALPHA CHARACTERS

Entering alpha characters (letters) into certain screens, such as an ENTER SAMPLE ID number, is accomplished through a special alpha screen. To access the alpha screen from the **Enter Sample Id** screen, press the **Next Page Key**. The **Next Page** key only functions if an alpha entry is possible.

To view and/or use the alpha screen:

1. Prepare for a moisture test. When the PRESS LOAD TO BEGIN message appears, stop and observe the screen. The ID field on the lower left corner below the grain type appears, and a small cursor will blink. If necessary, use the **Down Arrow** key to position the cursor next to the ID field (ID: _). Numbers are entered directly from the keypad and completed by pressing the **Enter** key.
2. To enter letters, press the **Next Page** key to access the **Alpha** screen. The **Alpha** screen displays the alphabet, special characters and a string of S numbers (S1...S10). On the lower left corner, the word TEXT will be displayed (refer to Figure 14).



Next Page Key



Down Arrow Key



Enter Key

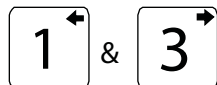

Left and Right Arrow Keys

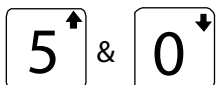

Up and Down Arrow Keys



Enter Key



Backspace Key



Previous Page Key

Figure 14

Alpha Screen

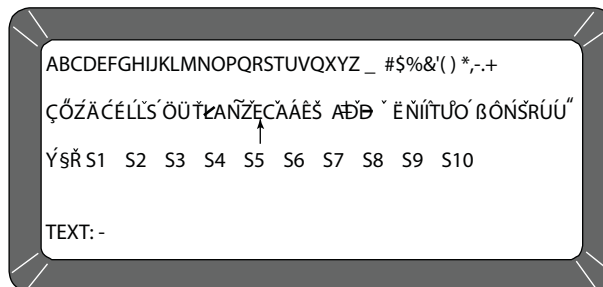

3. Move the vertical pointer (center of screen) to the first letter. The small vertical pointer identifies the selected character. The pointer is moved around the screen by using the four arrow keys (**Left/Right** and **Up/Down**).
4. After selecting a letter, press the **Enter** key. The letter will appear next to the word TEXT: on the lower corner. Repeat the process until the phrase is complete. If an error is made, press the **Backspace** key and reenter the corrected character.
5. After completing the text string, press the **Previous Page** key. The text string will become part of the ID field on the **Press Load To Begin** screen. Additional numbers may be inserted after the text string as before. Deleting is accomplished by entering the alpha screen again and using the **Backspace** key to delete letters. Using the S1 through S10 character strings is described in ESTABLISHING PARAMETERS. Character strings are predetermined phrases to insert into an alpha text line when needed (i.e. BROWN).

USE ID OPTIONS

ID numbers are typically used to identify grain samples. The numbers may be a simple number (e.g., 1, 2, 3, etc.), a combination of letters and numbers (i.e. operator's initials plus sample number) or the customer's name (i.e. BROWN). The ID field may contain up to 16 alpha numeric characters.

The ID option is selected through the **Setup** menu, ID OPTIONS (refer to ESTABLISHING PARAMETERS). ID numbers are added to each tested sample using one of three methods:

1. **Inserted Manually** - Any ID field, including none at all, may be assigned to grain samples before each test. This flexibility allows users to develop individualized numbering schemes.
2. **Automatic Sequencing** - Numbers may be sequentially assigned automatically to each moisture test. For example, 1, 2, 3, etc. or specific letters (i.e. initials) may be placed in front of the numbers (i.e. JW12). Only the numbers at the end of the field change automatically.
3. **Entry Required For ID** - An ID field is required before each moisture test may proceed. This method ensures each sample is properly



identified, typically for printer output. A screen will be displayed before the moisture test requests the user to ENTER SAMPLE ID. Alpha characters may be used if desired.

USE FACTORS (LABELS)

Factors are predetermined labels that appear at the beginning of each moisture test, similar to sample ID numbers. Up to four factors will display and print as specified in the calibration. For each FACTOR specified, an entry must be made before initiating the moisture measurement. Entries (numeric only) may be up to six digits long (refer to Figure 15). FACTORS are established on the **Setup** menu (refer to ESTABLISHING PARAMETERS).

Figure 15

Example of Factors

ENTER RESULTS FOR THE FOLLOWING:

CUSTOMER ID	54
VEHICLE NUMBER	4
CODE	382
LOAD WEIGHT	19535

WHEAT HRW ID: AB1234 960518

VIEW THE NEXT PAGE



Next Page Key

After the grain analysis is completed and the moisture content is displayed, <more> appears on the lower right corner of the screen indicating another page is available. Press the **Next Page** key to view the calculated values (D1, D2, D3 and D4) determined from the grain measurement (refer to Figure 16). These values are relatively unimportant to the operator but are important to service personnel. A general definition of each value is as follows:

- D1** - Conductance measurement to indicate grain surface moisture.
- D2** - Capacitance measurement to indicate internal grain moisture.
- D3** - Weight measurement to indicate grain weight.
- D4** - Temperature to indicate grain temperature.

Below the D calculations, the TEST WEIGHT OFFSET (as applicable) appears. This value is programmed on the **Setup** menu (refer to UP PARAMETERS). The current date, time, and sample ID are also displayed.



Figure 16

Next Page Typical Calculated D-Values

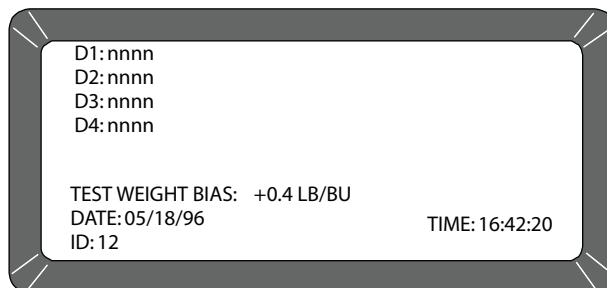

OPERATOR'S MANUAL





GRAIN SELECTION

The second item on the **Main** menu is the **Select Grain** menu, used to select specific grain types for testing. The **Select Grain** menu is automatically displayed for the first moisture test each time power is applied. It may also be selected at any time to test different grain types. After the first test, the **Select Grain** menu must be selected manually. One exception is through the use of QUICK KEYS. However, these are limited to three grain choices, usually the most common grains. The use of QUICK KEYS allows a programmed grain to be selected prior to loading the grain into the test cell (refer to MEASURING MOISTURE).

SELECT GRAIN MENU

The GAC 2100b stores up to 64 unique grain calibrations. The first 40 are restricted and may only be changed by authorized personnel. The remaining 24 are less secure and may be changed by the operator using the Access Code.

To select a grain for testing:

1. Choose the **Select Grain** menu from the **Main** menu by pressing the 2 key. The first page of the **Select Grain** menu displays the first eight grain calibrations available. The prompts on each lower corner of the display indicate additional pages are available (refer to Figure 17).
2. Press the **Next Page** key to advance to the next page. The next eight grain calibrations will be displayed. The **Next Page** key allows users to access all available eight pages. When the last page has been displayed, the <more> prompt will no longer remain visible on the screen.
3. Press the **Previous Page** key to move backward. The **Previous Page** key is the counterpart of the **Next Page** key.



Next Page Key



Previous Page Key

Figure 17

Select Grain Menus

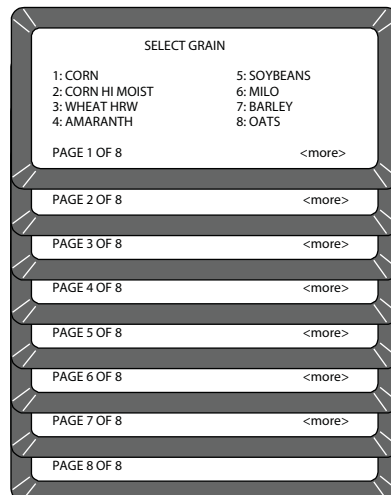



4. Choose the desired grain by selecting the number key corresponding to the desired grain. After selecting the grain, the GAC 2100b automatically enters the MEASURE MOISTURE mode and retains the grain selection until a new grain is selected again or the power is turned OFF.

QUICK KEYS

Changing grain types is accomplished in one of two ways. The standard method uses the **Select Grain** menu as described above.

A faster method of changing between grain types is the use of QUICK KEYS. Up to three keys may be programmed to quickly change between the most often used grains without having to choose the **Select Grains** menu.

Keys 1, 2, and 3 may be programmed on the **Setup** menu to remember specified grain types (refer to ESTABLISHING PARAMETERS). After programming, the operator changes the grain type by using one of the QUICK KEYS prior to starting a new test cycle. Whenever the **Press Load To Begin** screen is displayed (refer to Figure 13), press either the 1, 2, or 3 key. The grain type above the ID number will be changed to the selected grain type. The new measurement cycle is ready to measure the selected grain. To begin, press the **Load** key.



Load Key



CALIBRATING PROCEDURES

The **Calibration** menu allows authorized personnel to:

- view calibration constants of selected grains,
- enter new or change existing calibrations,
- print the entire list of stored grain calibrations,
- obtain calibration data necessary to generate new calibrations
- print audit memory data.

Choosing a function is achieved by selecting the number key corresponding to the desired function (refer to Figure 18).

Figure 18

Calibration Menu With Status Page

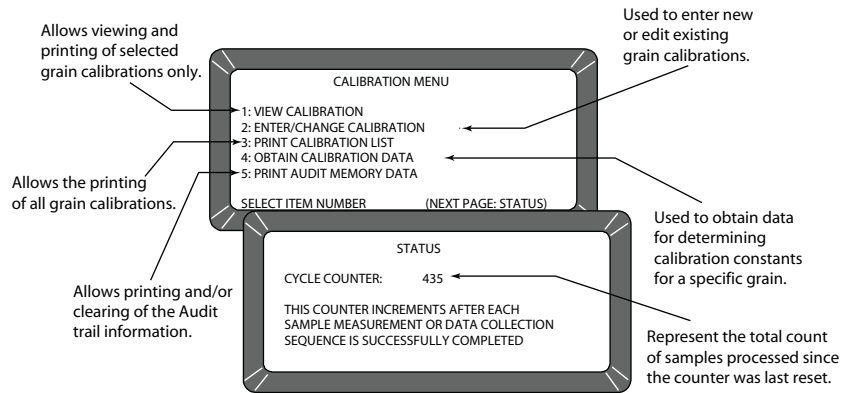

VIEW CALIBRATION DATA (1 KEY)

The **View Calibration** menu allows for the viewing and printing of a selected grain calibration (refer to Figure 19). Editing cannot be performed in this function.

To view grain calibrations:

1. From the **Calibration** menu, choose **View Calibration** by pressing the 1 key. PAGE 1 OF 8 grain pages is displayed.
2. Choose a grain calibration to view from the grain list pages and then select the corresponding number key. Use the **Next Page** key to view additional pages (refer to GRAIN SELECTION).
3. The **View Calibration** screen displays the grain name, moisture range, calibration issue date, and the nine calibration K values.
4. If a printer is connected, press the **Print** key to print a copy of the screen. If FACTORS are defined and AUTO RANGE is specified in the calibration, this information is also printed. The lower right corner of the **View Calibration** screen will indicate <more>, meaning another page is available.



Next Page Key



Print Key



Next Page Key

5. Press the **Next Page** key to display the **Factors** screen. The **Factors** screen displays the grain name and up to four defined factors. If the grain does not have defined factors, the labels are empty. The <more> prompt will also be displayed on this page.
6. Press the **Next Page** key again to view the **Auto Range** screen. The **Auto Range** screen displays grain name and calibrations automatically used to extend the moisture range if the normal maximum and minimum limits are exceeded. Separate grain calibrations or grains may be referenced for each limit.

Figure 19

View Calibration Menu Showing Wheat HRW

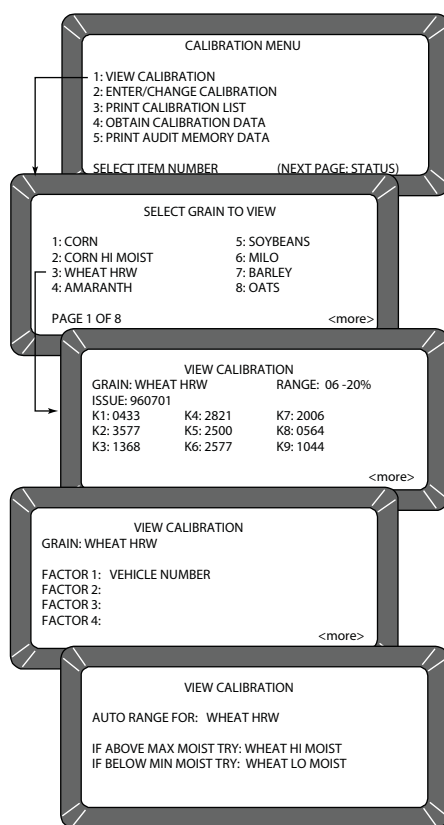

ENTER/CHANGE CALIBRATION VALUES (2 KEY)

This function enters or changes grain calibrations. Grains 1 through 40 are restricted to authorized personnel only. Grains 41 through 64 are considered “unofficial calibrations” and may be accessed by using the Access Code. Changing calibrations is also possible through proper linking with a computer (refer to the computer manual). The same security code restrictions exist. After gaining access, changes to calibrations may be accomplished (refer to Figure 20).



Figure 20
Changing Calibrations

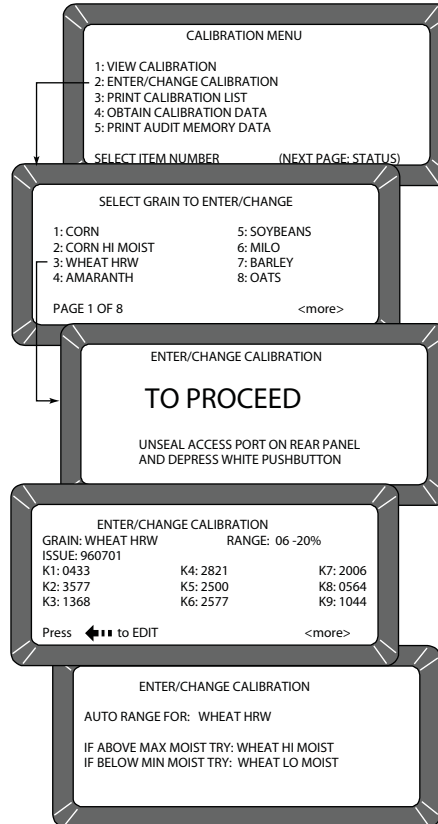

To enter/change calibration values:

1. From the **Calibration** menu, press the 2 key to access **Enter/change Calibration** screen. PAGE 1 OF 8 of the **Select Grain To Enter/Change** menu will be displayed. The remaining pages are accessed by pressing the **Next Page** and **Previous Page** keys.
2. Select the grain to be altered or locate an empty position to enter a new calibration. Select the appropriate key corresponding to the listing.
3. Determine whether the selected grain is located in the first 40 or the last 24. If the selection is on one of the first five grain pages (5 x 8 = 40), changing the calibration is restricted to authorized personnel only. A screen will be displayed stating TO PROCEED, UNSEAL ACCESS PORT ON REAR PANEL AND DEPRESS WHITE PUSHBUTTON.

IMPORTANT: Do not perform this action unless you are authorized (proceed to Step 4).

If the grain selection is on pages 6, 7 or 8, a message displays ENTER ACCESS CODE. These calibrations may be altered after responding to the request to ENTER ACCESS CODE. Entering the access code and then pressing the **Enter** key allows the user to proceed.



Next Page Key



Previous Page Key



Enter Key



Backspace Key



Next Page Key

*NOTE: Pressing the **Next Page** key instead of the **Backspace** key (to change the large flashing block to the cursor), advances to the **AUTO RANGE** function (refer to Step 14).*



Enter Key



Previous Page Key



Print Key

4. If selecting an existing calibration, a large flashing block will appear on the grain selection. The screen will display the current K values for that grain. The large flashing block signifies that alpha characters may be entered from the alpha screen. Pressing the **Backspace** key, as prompted on the bottom of the screen, causes the bottom prompt to disappear and the large flashing block to change to a cursor (flashing line). When the cursor appears, the alpha screen may be accessed by pressing the **Next Page** key. If numeric entries are desired, those values are made directly with the number keys.
5. Use the alpha screen to enter a grain name (up to 16 characters). Press the **Enter** key after each character selection to place the character on the text line.
6. Press the **Previous Page** key to return to the **Enter/Change Calibration** screen. Note that the new grain title is now in place.
7. Press the **Enter** key to accept the new grain title. The cursor will advance to the next position (Issue Date).
8. Enter the Calibration Issue Date (up to 8 characters) and press the **Enter** key. The cursor will return to a flashing block in the **ISSUE** position. The block signifies the date may include alpha characters (i.e. 15NOV98), but normally is entered as numbers in a format such as YYMMDD (i.e. 981115). Pressing the **Backspace** key will cause the flashing block to disappear, allowing the **Next Page** key to be used for selecting the alpha screen.
9. Press the **Enter** key to accept the date. The cursor will appear as a line (flashing) under the first digit of K1 (constant). The flashing cursor (line) signifies this entry accepts only numbers.
10. Enter the K1 constant. Notice when entering the first digit the remaining spaces blank. All four digits of the constant must be entered when making a change. If more than four digits are entered, a long beep will indicate an illegal entry.
11. When finished, press the **Enter** key to accept the constant and to advance to the next position. If the screen is accidentally advanced before finishing, press the **Enter** key as many times as necessary to cycle through all menu items.
12. Enter K2 through K9 constants in the same manner as K1. Press the **Enter** key after entering each constant (4 digits).
13. Press the **Print** key to print the calibration. The present screen values print.
14. Press the **Next Page** key to enter the **Auto Range** calibration selection. The **Auto Range** screen allows entry for grains using higher or lower moisture levels than the current calibration. These values are automatically selected if the grain moisture is outside the standard setting.
15. Press the **Backspace** key and choose a grain calibration to be used if the sample moisture is above the upper limit. After selecting a grain, the display will return to the **Auto Range** screen. Repeat this procedure again for the lower limit grain calibration.
16. Press the 0 (zero) key to delete either auto range calibration. Press the **Previous Page** key to return to the **Grain Calibration** screen.



Figure 21
Printing Calibration Lists

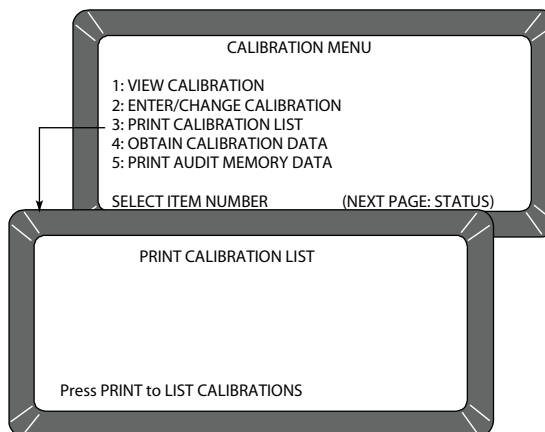

PRINT CALIBRATION GRAIN LIST (3 KEY)

A printout of all grain calibrations stored in memory may be obtained by pressing the **Print** key (refer to Figure 21).

To print a calibration list:

1. Press the 3 key from the **Calibration** menu. The **Print Calibration List** screen will appear.
2. Press the **Print** key. The list of all grain calibrations will print.

OBTAIN BASIC CALIBRATION DATA (4 KEY)

This mode allows the user to generate data for developing grain calibrations. The samples used for calibration should span the desired moisture range.

In order to obtain good calibration data, the samples must be as evenly distributed throughout the moisture range as possible. The grain samples should extend at least 2% past each end of the desired moisture range, should contain no spoilage or condensation, and be free of broken pieces or foreign matter. The GAC 2100b readings obtained may be sent to DICKEY-john to derive the calibration constants for the new grain.

To obtain accurate calibration constants:

1. Turn the GAC 2100b power switch ON and allow approximately thirty minutes to warm up before taking sample readings. Turn the printer ON. Be certain the GAC 2100b is set up and functioning properly.
2. From the **Main** menu, choose the **Calibration** menu by pressing the 3 key. Then access OBTAIN CALIBRATION DATA by pressing the 4 key.
3. Enter a sample identification number so the sample will be properly identified. Key in a sample ID number (use the **Next Page** key if an alpha ID is desired). Press the **Enter** key. Pour the sample into the hopper and press the **Load** key.



Print Key



Next Page Key



Enter Key



Load Key



- After the measurement cycle is complete, the screen displays four D values (refer to Figure 22). If using a printer, a printout will automatically result. If a printer is not being used, record the D-values and sample ID.

Figure 22
Obtaining Calibration Data

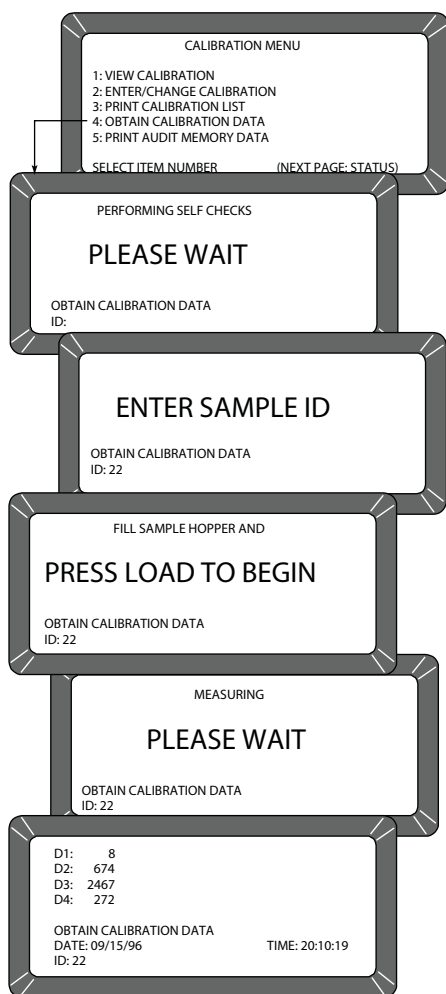

NOTE: *The Facility Name and Location, Date/Time, GAC 2100b Serial Number and CALIBRATION DATA only print when the first sample is run in this mode (See Figure 23).*

- Write the grain type under the CALIBRATION DATA. Write the actual moisture percentage of each sample (obtained by an accurate approved means) next to STD. MOIST. Run additional samples.
- Run as many samples as possible, making sure to record the actual moisture percentage for each sample. After running each sample, press the **Unload** key.



Unload Key



Figure 23

Calibration Data Printout

```
DICKEY-JOHN
10653

04/21/98 06:42:33

S/N: 1640-10653

CALIBRATION DATA

=====

ID:      1

STD.MOIST:

          D1:    0
          D2:   14
          D3:    2
          D4:  179

=====
```

PRINT AUDIT MEMORY DATA (5 KEY)

The audit memory records data changes made to parameters affecting moisture measurement or the display of the measurement data. The audit memory stores the following types of data:

- grain calibration settings
- output options settings
- date and time settings
- test weight bias adjustment settings

The memory contents may be printed at any time by an operator. Printing of the audit memory may be initiated from either the unit or the computer site (refer to Figure 25). For additional information concerning printing from the computer, refer to the Communications Software manual.

To print the audit memory contents:

1. From the **Main** menu, access the **Calibration** menu by pressing the 3 key. Access PRINT AUDIT MEMORY DATA by selecting the 5 key. A screen will be appear displaying PRESS PRINT TO BEGIN.
2. Press the **Print** key to obtain a printout of the audit memory (refer to Figure 24). Multiple copies may be produced by pressing the **Print** key again when the printer finishes. If only the header, current date, current time, and GAC 2100 serial number print during this process, the audit memory is empty.



Print Key



Figure 24
Audit Memory Data

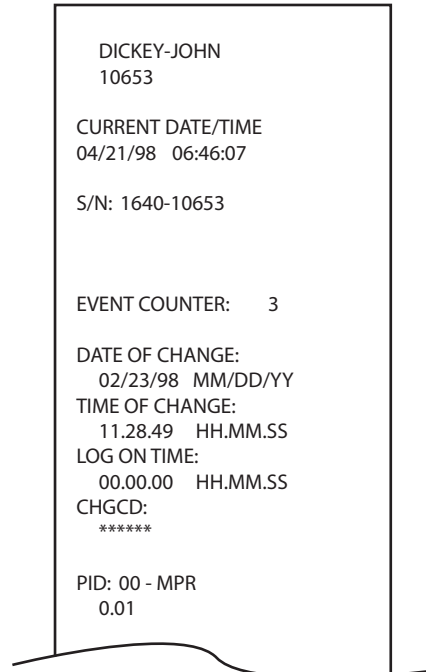
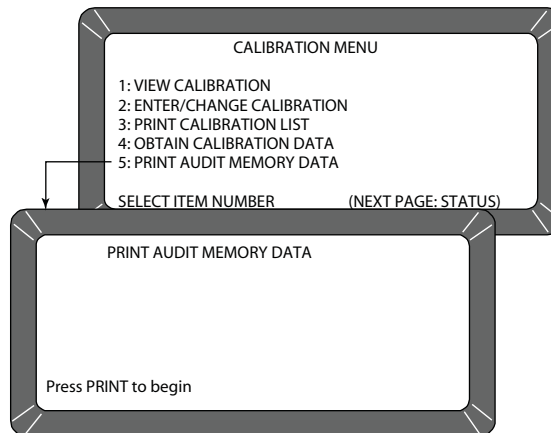

Figure 25
Printing Audit Memory Data



Previous Page Key

3. After printing, press the **Previous Page** key to return to the **Calibration** menu. The audit memory retains up to 1000 recorded changes called **EVENTS**. When the audit memory becomes full, the oldest event is overwritten to create space for the new event. It is



recommended the audit memory be printed periodically to preserve a permanent history of events.

Each event lists the (1) date of change, (2) time of change, (3) log on time and (4) user code (refer to Figure 24). The user code prints asterisks to maintain user code security. The event (or change) is identified with a PID (Parameter Identification), a colon and then a code to indicate the specific type of change (refer to Table 1). The printout begins with the most recent event and progresses in reverse order to the oldest event.

PID:	Definition of Terms
CB	Calibration
USRCD	User Code
OO - D&OTW	Output Option - Display & Output Test Wright
OO - D & OT	Output Option - Display & Output Temperature
OO - DOOLR	Output Option - Display & Out-Of-Limits Results
OO - OOOLR	Output Option - Output Out-Of-Limits Results
OO - OROAE	Output Option - Output Report Of All Errors
OO - MPR	Output Option - Moisture Printout Resolution
OO - RP	Output Option - Radix Point
OO - TF	Output Option - Temperature Format
OO - WF	Output Option - Weight Format
TIME	Time
DATE	Date
DATE FORMAT	Date Format





ESTABLISHING PARAMETERS

The **Setup** menu establishes basic operating parameters for the unit. These parameters include resetting the cycle counter, ID options, output options, setting the access code, setting date and time, entering labels, configuring communication ports, and selecting quick keys.

From the **Main** menu, the **Setup** menu is accessed by selecting the 4 key (refer to Figure 26). From the **Setup** menu, eight sub-menus will appear on the first page, along with two more on the next page. Most functions require the access code before changes can occur. If the access code has not been changed, the factory installed temporary code is set for 0 (zero).

Figure 26

Setup Menu Choices

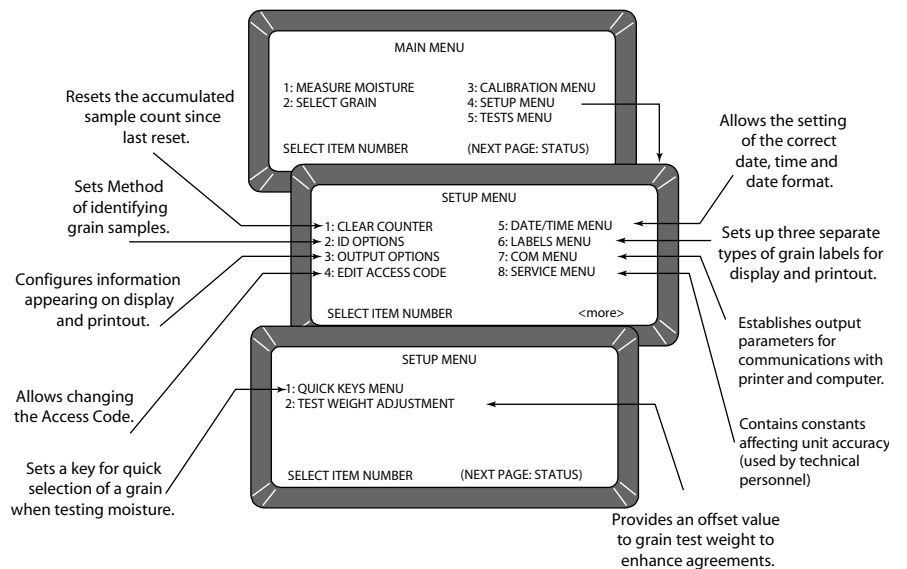

CLEAR CYCLE COUNTER (1 KEY)

NOTE: The date, time and cycle counter values are automatically sent to the COM1 and COM2 Ports each time the counter is cleared, resulting in a printout of the most recently cleared counter contents. The printout should be retained for records.

The **CYCLE COUNTER** increments once each time a moisture measurement or data collection sequence is successful. The screen displays the total counts accumulated since the last reset.

To reset the cycle counter:

1. From the **Setup** menu, press the 1 key (refer to Figure 27). A screen will be appear displaying **ENTER ACCESS CODE**.
2. Enter the current personal access code (or 0) and press the **Enter** key. Enter 0 if the code has not been changed from factory settings.
3. Press the **Enter** key again to reset the number (count) to zero. The counter will return to zero.



Enter Key



Figure 27
Clearing The Cycle Counter

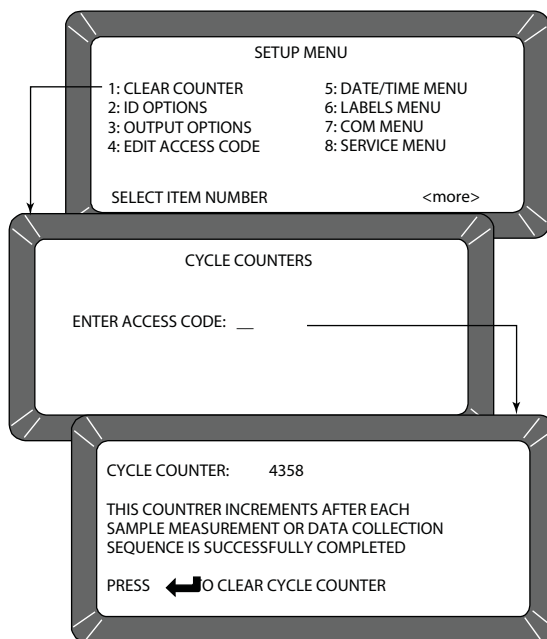

CHOOSE ID OPTIONS (2 KEY)

ID OPTIONS determine how each moisture measurement sample is identified on the output data. ID numbers appear in the lower left corner of each test result screen. All sample ID numbers may contain up to 16 alphanumeric characters. Three methods of sample identification are available for display:

- **AUTOMATIC SEQUENTIAL ID** – Automatically increments once for each measurement cycle, but resets each time the unit is turned OFF
- **ENTER REQUIRED FOR ID** – With each measurement, a screen will appear displaying ENTER SAMPLE ID before the grain sample is measured. This option ensures the operator assigns a grain sample identification number/label for each test printout.
- **Optional Entry ID** – If both of the selections have been checked NO, the ID number may be added to each measurement manually or not at all. Manually added ID numbers do not require any specific format or sequencing.

To Configure the ID Options:

1. From the **Setup** menu, press the 2 key to access the **ID Options** screen (refer to Figure 28). A screen will appear displaying ENTER ACCESS CODE.
2. Enter the access code (or 0) and press the **Enter** key. The **ID Option** screen displays only two lines but allows three choices – the AUTOMATIC SEQUENTIAL ID and ENTER REQUIRED FOR ID functions cannot both be enabled (YES) at the same time.



Enter Key

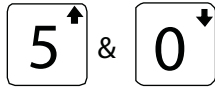

Up and Down Arrow keys

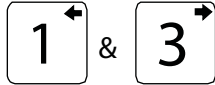

Left and Right Arrow Keys

3. Select the desired function. Use the **Up/Down Arrow** keys (0 and 5 keys) to select and the **Left/Right Arrow** keys (1 and 3 key) to set the desired value. If both selections are set to NO, grain sample ID is optional by the operator for each test.

Figure 28

Selecting ID Options

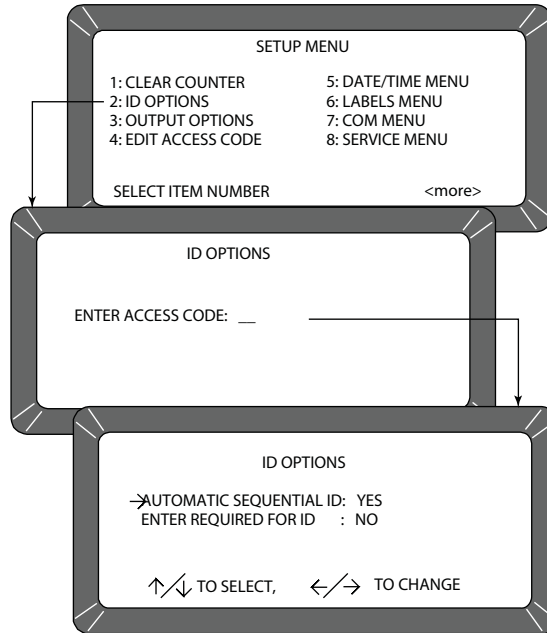

CONFIGURE OUTPUT OPTIONS (3 KEY)

OUTPUT OPTIONS configure information appearing on the display/printer for measured test results (refer to Figure 29). These selections are typically made once and not changed again, but may be altered as necessary. Selections are available only to authorized personnel through either the User ID Code from the computer site or as outlined below.

To change the output options:

1. From the **Setup** menu, select OUTPUT OPTIONS (3 key). A screen will appear displaying instructions on how TO PROCEED.
2. If access is authorized, locate and select the small white push-button under the sealed access panel at the rear of the unit. The panel is located in the lower left rear corner (viewed from rear) of the unit. The push button is on the circuit board assembly inside the cavity.
3. Verify each option and set as necessary. Three pages must be verified (refer to Figure 29). Use the **Up/Down Arrow** keys (0 or 5) to select functions and the **Left/Right Arrow** keys (1 or 3) to set each function to the appropriate setting. Options include:
 - **DISPLAY AND OUTPUT TEST WEIGHT:** Enables/disables (YES/NO) approximate grain test weight to display and print. If NO, test weight will not be displayed or printed. If YES, test weight will be displayed and printed according to the calibration type as follows:



NTEP APPROVED FOR TEST WEIGHT CALIBRATION has an issue date ending in “N” and “99” as the first two characters of K8. Test weight will be displayed and printed as DENSITY and requires a full hopper to initiate a measurement.

NTEP CALIBRATION has an issue date ending in “N” but the first two characters of K8 are not “99”. Test weight will not be displayed or printed and a full hopper is not required.

NON-NTEP CALIBRATION has an issue date that does not end with an “N”. Test weight will be displayed and printed as APPROX DENSITY and a full hopper is not required.

- **DISPLAY AND OUTPUT TEMPERATURE:** Enables/disables (YES/NO) grain temperature to display and print.
- **DISPLAY OUT-OF-LIMITS RESULT:** Error messages flash on the display each time tested grain parameters exceed the normal range of that particular grain. If enabled, three standard parameters are displayed – moisture, grain temperature, and approximate grain test weight. Each measured parameter value appears next to its respective legend on the display. The display out-of-limit options selected below establish whether or not the enabled values appear on the display. Eight separate settings are available for suppressing the enabled grain parameters.

For the NTEP (National Type Evaluation Program) unit, the parameter values are to be suppressed if the temperature values are outside the established limits. Therefore, option MW is to be selected.

1. **YES** - Enabled readings display for all out-of-limit conditions.
 2. **NO** - Enabled readings do not display for any out-of-limit condition.
 3. **M** - Enabled readings display if **moisture** is out-of-limits but do not display if either **weight** and/or **temperature** is out-of-limits.
 4. **W** - Enabled readings display if **weight** is out-of-limits but do not display if either **moisture** and/or **temperature** is out-of-limits.
 5. **T** - Enabled readings display if **temperature** is out-of-limits but do not display if either **weight** and/or **moisture** is out-of-limits.
 6. **MW**- Enabled readings display if **moisture** and/or **weight** is out-of-limits but do not display if **temperature** is out of limits. This is the current approved setting for NTEP units.
 7. **MT** -Enabled readings display if **moisture** and/or **temperature** is out-of-limits but do not display if **weight** is out-of-limits.
 8. **WT** - Enabled readings display if **weight** and/or **temperature** is out-of-limits but do not display if **moisture** is out-of-limits.
- **OUTPUT OUT-OF-LIMITS RESULT:** If enabled, three standard parameters are printed – moisture, grain temperature and approximate grain test weight. Each measured parameter value appears next to its respective legend on the printout. The output out-of-limit options selected establish whether or not the enabled



- values print. These choices are identical to the display out-of-limits conditions above and are selected in a similar fashion.
- **OUTPUT REPORT OF ALL ERRORS:** Enables all internal checked errors to print.
 - **MOISTURE PRINTOUT RESOLUTION:** Selects the resolution to either one tenth (0.1) percent or one hundredth (0.01) percent for moisture printout.
 - **RADIX POINT:** Selects a decimal point (.) or comma (,) to display and printout.
 - **TEMPERATURE FORMAT:** Selects either degrees C (°C) or degrees F (°F) to display and print out for temperature.
 - **WEIGHT FORMAT:** Selects either pounds per bushel (lb/bu) or kilograms per hectoliter (kg/hl) to display and printout.

Figure 29
Setting Output Options

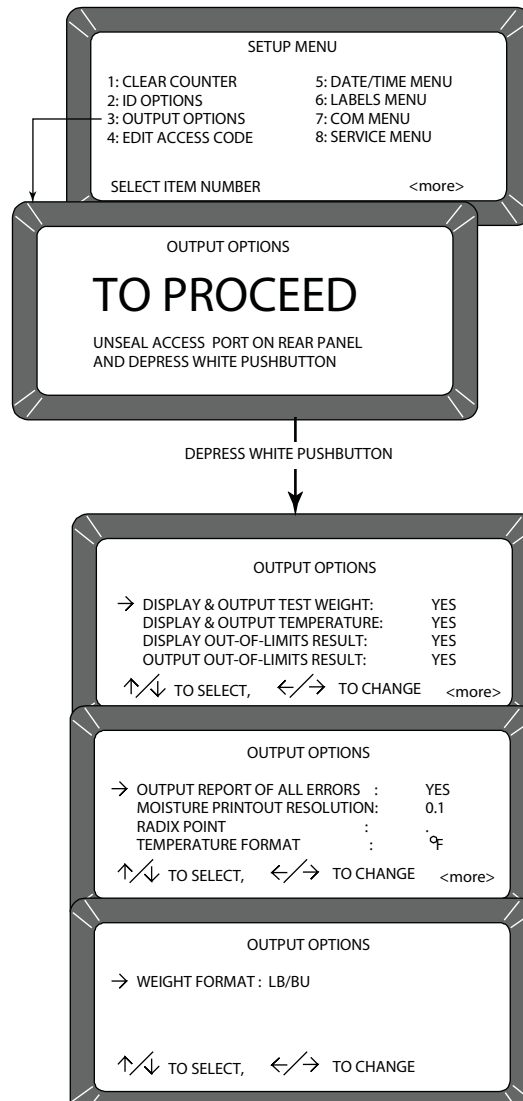



CHANGE ACCESS CODE (4 KEY)

The Access Code establishes a security level for nearly all **Setup** Menu functions. Also, this code allows changing/modifying the **unofficial grain calibrations** (refer to CALIBRATING PROCEDURES).

A higher security level is reserved for authorized personnel to make **official grain calibration** changes. Access to these changes is by breaking the seal on the rear panel of the unit and depressing the push button inside the access panel when prompted.

NOTE: The access code is set to 0 when shipped from the factory. After selecting a different code, record the new number and store for safe keeping. **DO NOT** lose the new code.



Enter Key

To change the access code:

1. From the **Setup** menu, select the EDIT ACCESS CODE (4 key). The screen will appear displaying ENTER ACCESS CODE.
2. Enter the present code (or 0 if set at factory code) and press the **Enter** key. The **Edit Access Code** screen will display a blank (to be filled in). The present access code will appear to the right (refer to Figure 30).
3. Enter the new access code. Choose any numeric code of up to 4-digits. Enter the number and press the **Enter** key. The new number must be used from this point forward to enter the access code level secured screens.

NOTE: Operation from the computer is described in a separate Communications Software manual.

Figure 30
Changing The Access Code

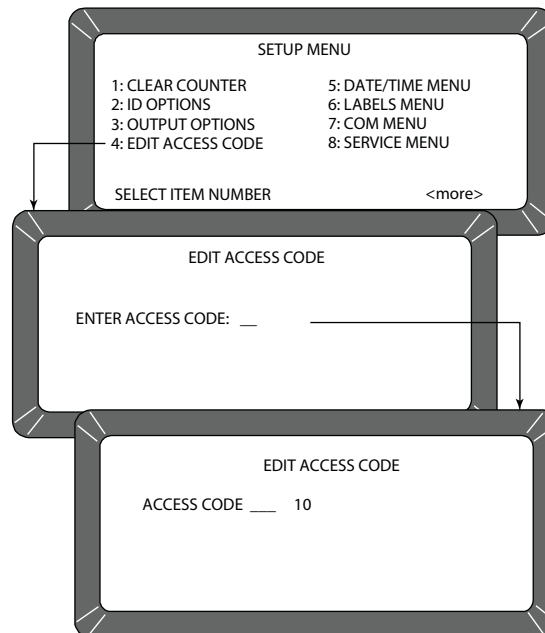



CHANGE DATE, TIME, AND DATE FORMAT (5 KEY)

This function establishes correct date and time for display and print out with each grain moisture measurement.

To set the time:

1. From the **Setup** menu, select the **Date/Time** menu (5 key). Three options are available; (1) SET TIME, (2) SET DATE and (3) SET DATE FORMAT (refer to Figure 31).
2. From the **Date/Time** menu, SET TIME using the 1 key. The **Set Time** screen will appear and display ENTER ACCESS CODE.
3. Enter the access code and press the **Enter** key. The time will be displayed based upon a 24-hour clock.
4. Change the time by entering new numbers from the keyboard. The time format is in hours, minutes, seconds (HH.MM.SS). Each unit is two digits and is separated by a decimal point. For example, to enter 3:32:59 P.M., enter 15.32.59. Be sure to use the decimal point to separate units. If accuracy is desired, set the time slightly ahead and wait. At the exact time, press the **Enter** key to start the clock.



Enter Key

Figure 31

Setting The Time

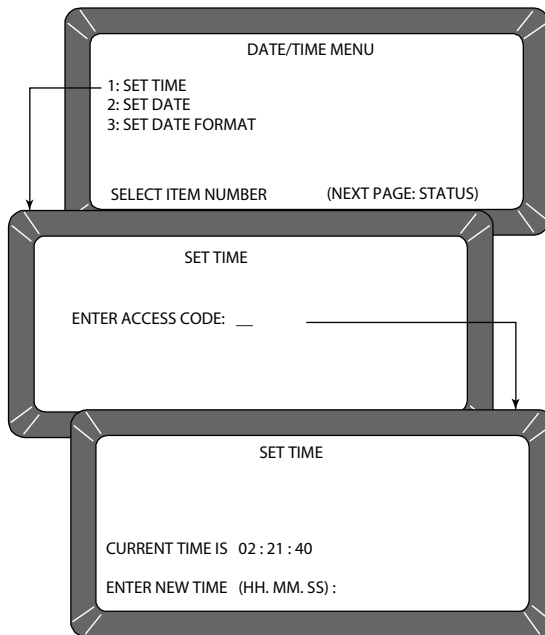

To change the date:

1. From the **Date/Time** menu, select the SET DATE (2 key) menu (refer to Figure 32). The **Set Date** screen will display ENTER ACCESS CODE.
2. Enter the access code to gain and select the **Enter** key. Enter numbers in the format shown at the bottom of the display: month.day.year. Each



Enter Key

date component is two digits in length and separated by a decimal point (i.e. to enter 9/15/98, enter 09.15.98). The number appears on the left end of the bottom line. Press the **Enter** key to accept the corrected date.

Figure 32
Setting The Date

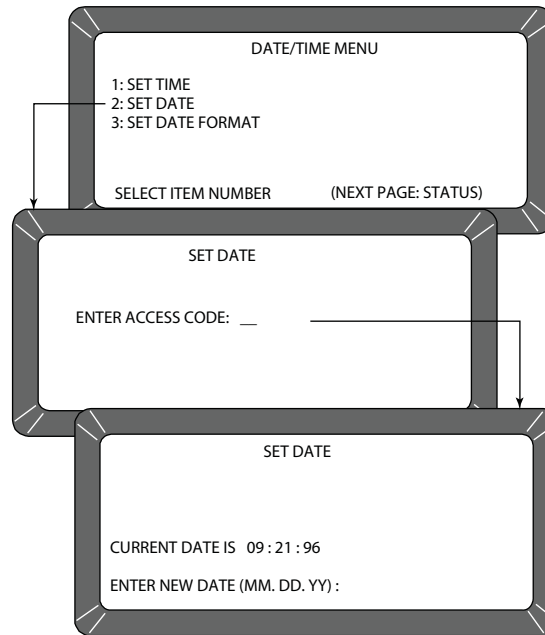

To change the date format:

1. From the **Date/Time** menu, select the SET DATE FORMAT (3 key) menu (refer to Figure 33). The screen will display ENTER ACCESS CODE.
2. Enter the access code and select the **Enter** key. The date format may be configured in one of three formats:
 - MM/DD/YY
 - DD/MM/YY
 - YY/MM/DD.
3. Press the **Left** or **Right Arrow** keys (1 or 3) to select one of the three formats. When finished, press the **Previous Page** key to accept the choice and return to the **Date/Time** menu. Press the **Previous Page** key once more to return to the **Setup** menu.

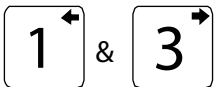

Left and Right Arrow Keys



Previous Page Key



Figure 33
Setting Date Format

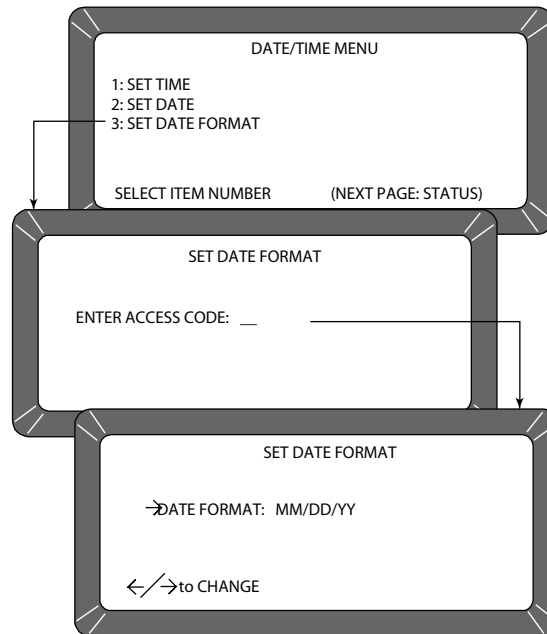

CHANGE LABELS (6 KEY)

The **Labels** menu allows editing of three label types:

- user name
- text strings
- factor names

Each of these labels attach to the grain moisture measurements in some fashion. Editing of each label type is similar. The basic procedure is outlined in the following five steps. Specific details and illustrations for each label follow the basic outline (refer to Figures 34, 35 and 36).

- **USER NAME** – This heading appears on each measurement printout (not the display) and may be the organization's name. The user name may be two lines of up to 16 characters each.
- **TEXT STRINGS** – These are brief, commonly used words or phrases added to the alpha screen for quick selection (e.g., a name, company, etc.) when using alpha characters. After programming, each phrase is selected in the same manner as choosing a single character. Up to ten text strings may be preset. Each string is identified on the alpha screen by an S number (S1 through S10).
- **FACTOR NAMES** – These are entered as identifiers of specific details for particular grains. When using factors with particular grains, each factor name must be entered before the test may proceed.



Figure 34
Editing User Name

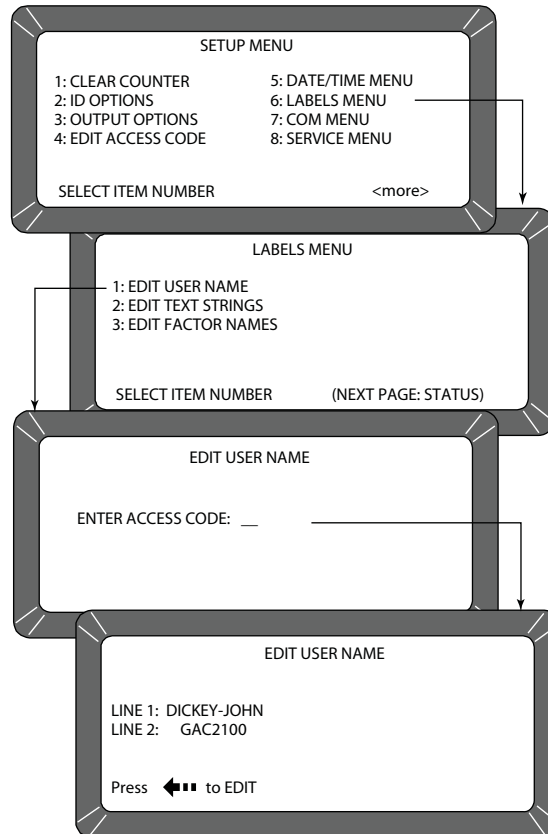

To create labels:

1. From the **Setup** menu, select the **Labels** menu (6 key). The **Labels** menu offers choices:
 - edit user name
 - edit text strings
 - edit factor names.
2. Choose the label of interest by selecting the key number next to the label type. The **Enter Access Code** screen will be displayed.
3. Enter the access code and then press the **Enter** key. For the user name (refer to Figure 34) or the text string (refer to Figure 35) screens, a large flashing block will highlight the first character to be edited. Press the **Backspace** key as directed by the prompt on the bottom corner of the display. The prompt will disappear and is replaced with a cursor (underline) beneath the first character of the first line. FACTORS (e.g., customer id, vehicle no, load weight, etc.) are assigned to individual grains. For factor names (refer to Figure 36), the **Select Grain To Enter/Change** menu will appear and request the selection of a grain name to assign the factor(s). Up to four factors may be assigned to each grain. After selecting a grain, the **EDIT FACTOR NAMES** will appear to be entered.



Enter Key



Backspace Key



Backspace Key



Enter Key



Previous Page Key

To delete existing factor names from the grain calibration, begin by selecting the grain and the factor name to be deleted. Press the **Backspace** key first, then any numeric key. Press the **Backspace** key a second time and then press the **Enter** key. The factor name should be blank.

4. Enter the selected characters/numbers to reflect the label. Numbers and letters may be mixed by using the alpha screen.
5. When completed, press the **Previous Page** key to return to the **Labels** menu.

Figure 35
Editing Text Strings

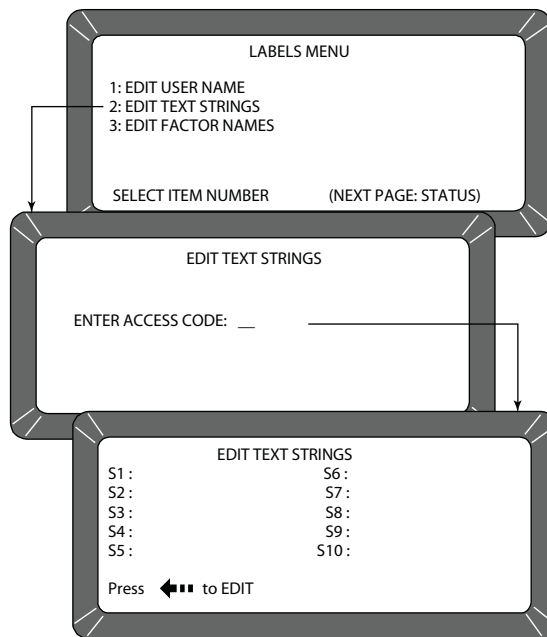
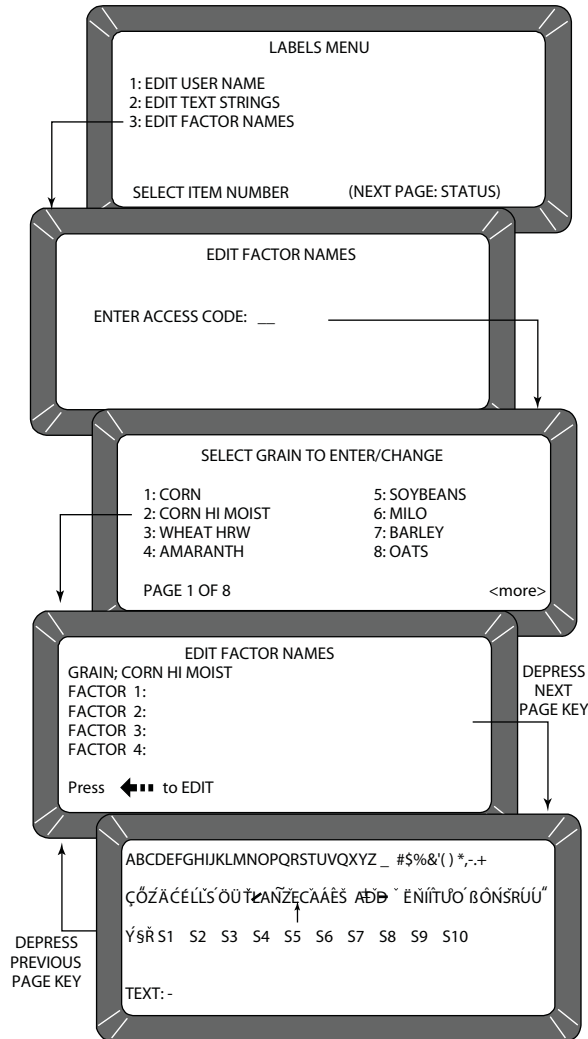



Figure 36
Editing Factor Names



SET COMMUNICATIONS PORT PARAMETERS (7 KEY)

Selection of the **COM (Communications)** menu is established through the Setup menu by selecting the 7 key. From this menu, the operator selects output parameters for communicating with external devices such as a PC computer and/or a printer. Two port connectors appear on the rear of the unit directly above the sealed access cover. The COM1 (Data Communications Equipment) port connector is located above the COM2 (Data Terminal Equipment) port connector. The **COM** menu contains eight items with number 5 non-active (refer to Figure 37). Selections 2, 3, and 4 configure the COM1 port while 6, 7, and 8 configure the COM2 port. Each of the **COM** menu items is edited in a similar fashion.



Enter Key

To configure the communications ports (Basic entry procedure – Follow-up to specific subject for finishing details):

1. From the **Main** menu, press the 4 key (**Setup** menu) and then the 7 key (**COM** menu). The **Communications** menu will appear with seven active choices and one non-active selection.
2. Choose the desired function by selecting the key number next to the choice. The **Enter Access Code** screen will appear.
3. Enter the access code and then press the **Enter** key. The selected COM screen will appear, ready for editing.
4. Proceed with the necessary editing of the selection.

The selections are:

- COM port select
- COM1 or COM2 format
- COM1 or COM2 serial data setup
- COM1 or COM2 control lead setup

Figure 37

Accessing The COM Menu

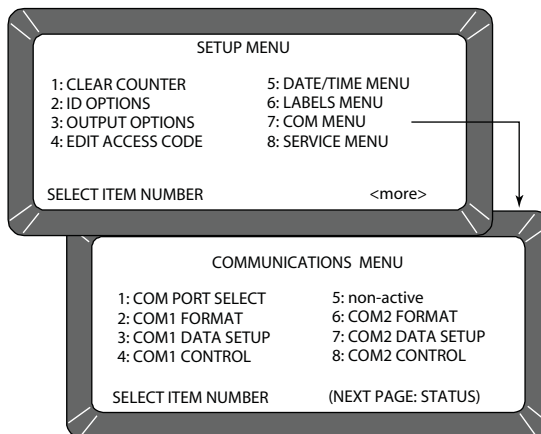

To configure COM PORT SELECT (press the 1 key on the **Communications** menu):

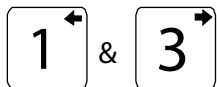

Left and Right Arrow Keys

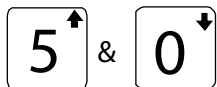

Up and Down Arrow Keys

1. After completing steps 1 through 4 from the basic entry procedure, edit the configuration. Four items will appear on the menu for editing and configuring output information of both ports (COM1 and COM2). Each item may be set to NONE, COM1, COM2 or COM1/COM2 (both ports) using the **Left/Right Arrow** keys to cycle through the choices. The pointer in front of each item may be moved with the **Up/Down Arrow** keys.



Print Key



Previous Page Key

The four outputs are defined as follows (refer to Figure 38):

- **AUTOMATIC RESULTS OUTPUT** - The configured port produces an output to automatically print the moisture results.
 - **MANUAL RESULTS OUTPUT** - Produces a printout for the configured port of the results by pressing the **Print** key. Repeatedly selecting the **Print** key results in duplicate copies.
 - **ERROR REPORT OUTPUT** - The configured port produces a printout of errors occurring during internal self checks. Out of limit errors of measured results do not print.
 - **SETUP AND TEST OUTPUT** - The configured port produces a printout of setup and test data by pressing the **Print** key.
2. Once editing is complete, press the **Previous Page** key to return to the **Communications** menu and for the next selection.

Figure 38

Accessing COM Port Select

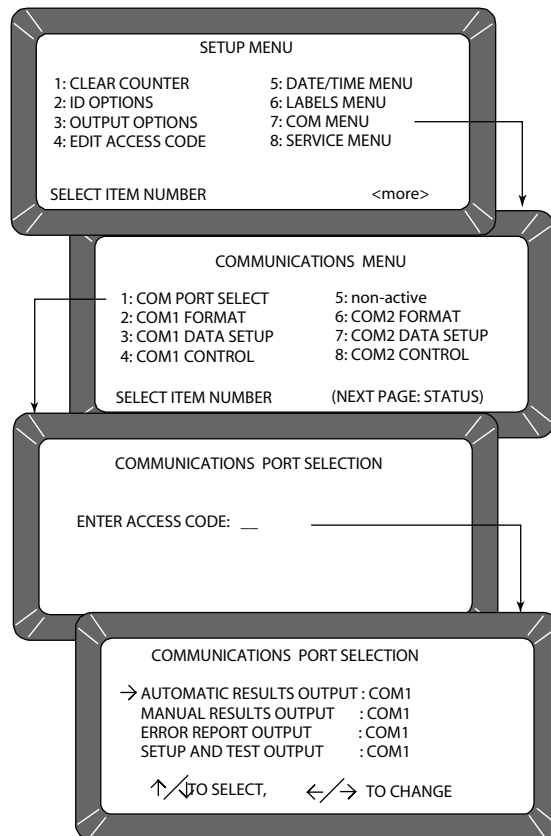

To configure COM1 or COM2 format (2 or 6 key from the **Communications** menu):

1. After completing Steps 1 through 4 from the basic entry procedure, edit the configuration. Both the COM1 FORMAT and COM2 FORMAT selections are similar and therefore are described together. The **COM Format Selection** menu will display two lines each containing several choices (refer to Figure 39).

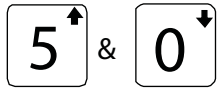

Up and Down Arrow Keys

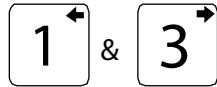

Left and Right Arrow Keys



Previous Page Key

2. Select the OUTPUT FORMAT using the pointer (refer to Figure 39). Place the pointer in front of the correct line with the **Up/Down Arrow** keys.
3. Edit the line by using the **Left/Right Arrow** keys to cycle through six variations. Select the appropriate format from the following six choices:
 - PRN20 - Standard 20 column printer output.
 - PRN80 - Standard 80 column printer output.
 - TST20 - 20 column test output of printer parameters.
 - PRN81 - Standard 80 column printer output (2 lines).
 - CSV01 - Comma separated variables.
 - PRN21 - Special 20 column printer output. PRN 20 format with the Grain Calibration Date Code, Instrument Serial Number and D-values removed.
4. Select the LINE TERMINATOR with the pointer. An RS-232 line of input data must be terminated with one of the following characters or character pairs.
 - LF (Line Feed) 0A Hex
 - CR (Carriage Return) 0D Hex
 - LF + CR 0A,0D Hex
 - CR + LF 0D,0A Hex
5. After editing is complete, press the **Previous Page** key to return to the **Communications** menu for the next selection.

Figure 39
Setting Output Format

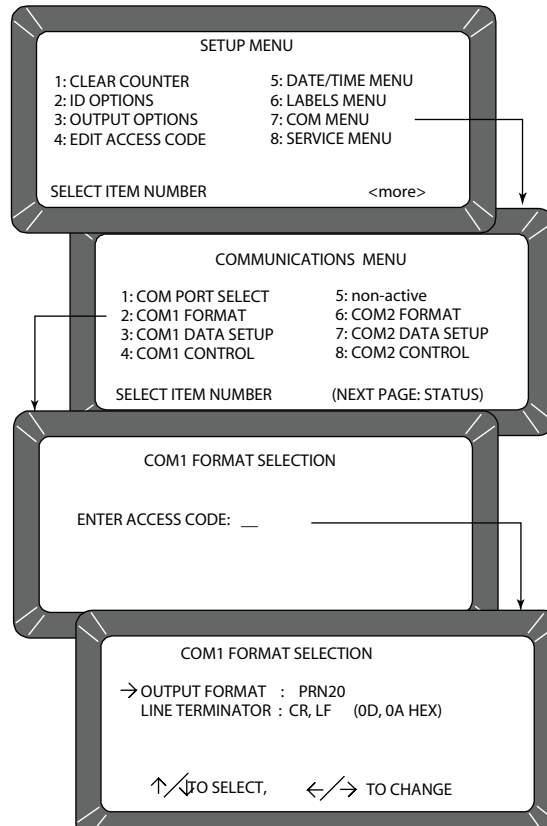



NOTE: For modem use of COM2, the Baud Rate should be set to 4800 or higher. Refer to your modem manufacturer's instructions for correct operation.

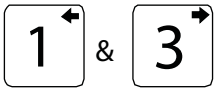

Left and Right Arrow Keys



Previous Page Key

To configure COM1 or COM2 SERIAL DATA SETUP (3 and 7 keys on the **Communications** menu):

Both the COM1 and COM2 SERIAL DATA SETUP selections are similar and therefore described together.

1. After completing Steps 1 through 4 from the basic entry procedure, edit the configuration. Either of the **COM Serial Data Setup** menus display four lines, but only the top line (Baud rate) may be changed for the COM1 SERIAL DATA SETUP (refer to Figure 40). Select the baud rate line for the COM1 SERIAL DATA SETUP of the printer. Use the **Left/Right Arrow** keys (1 or 3 key) to cycle the Baud Rate through seven choices: 300, 600, 1200, 2400, 4800, 9600, and 19200 bits/second. Choose the one that matches the rate of the equipment in use.
2. Select the DATA BITS, PARITY and STOP BITS in that order. These items for the COM1 port cannot be changed. The COM2 port items may be adjusted. Definitions of each item is as follows:
 - DATA BITS – Set for 7- or 8-bit character lengths.
 - PARITY – Set to NONE, EVEN or ODD by using the **Left/right Arrow** keys.
 - STOP BITS – Set to 1 or 2.
3. After editing is complete, press the **Previous Page** key to return to the **Communications** menu for the next selection.

Figure 40

Accessing The COM1 Serial Data Setup Screen

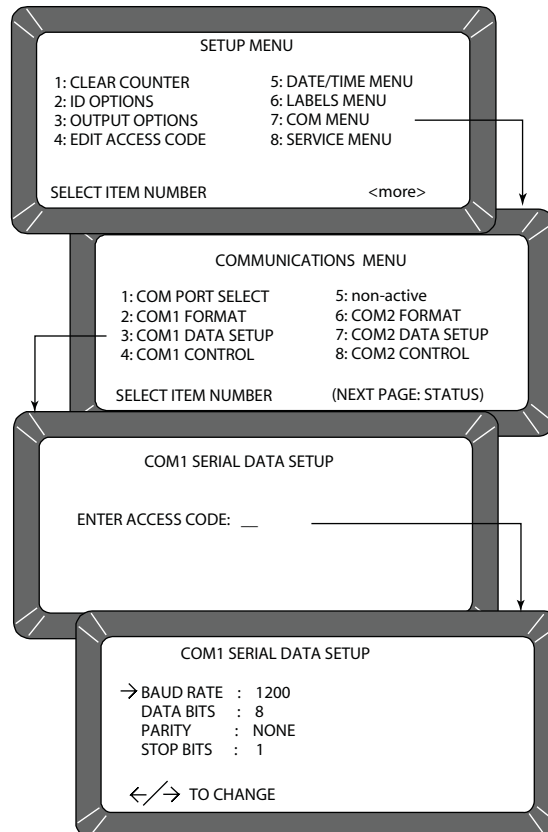



To Configure COM1 or COM2 CONTROL LEAD SETUP (4 or 8 Keys from the **Communications** menu):

Both the COM1 and COM2 CONTROL LEAD SETUP selections are similar and therefore described together in this procedure (refer to Figure 41). Differences are noted as applicable.

1. After completing Steps 1 through 4 from the basic entry procedure, edit the configuration of the COM1 Port screen. The **COM1 (DCE) Control Lead Setup** menu will display two lines (refer to Figure 41, **Accessing COM Control Lead Setup** screens).

The busy line, BUSY (11), notifies the GAC 2100 when the buffer in the printer (computer) is full and cannot accept more data. The polarity of this line is important and is set to be compatible with the printer. The control lead busy sense has three polarity choices: IGNORE, ACTIVE (+) or ACTIVE (-).

The DTR (20) (data terminal ready) line notifies the GAC 2100 that the printer (computer) is turned ON. The Control Lead DTR Sense has two states: IGNORE or ACTIVE.

2. Edit the configuration of the COM2 Port screen. The COM2 (DTE) **Control Lead Setup** menu displays seven items (refer to Figure 41, **Accessing COM Control Lead Setup** screens), but only three lines may be edited.
 - MODE : TRANSMIT ONLY or AUTO ANSWER
 - RTS (4): ON (+) or AUTO
 - DSR (6): IGNORE or ACTIVE
3. After editing is complete, press the **Previous Page** key to return to the **Communications** menu for the next selection.



Previous Page Key



Figure 41
Accessing COM Control Lead Setup Screen

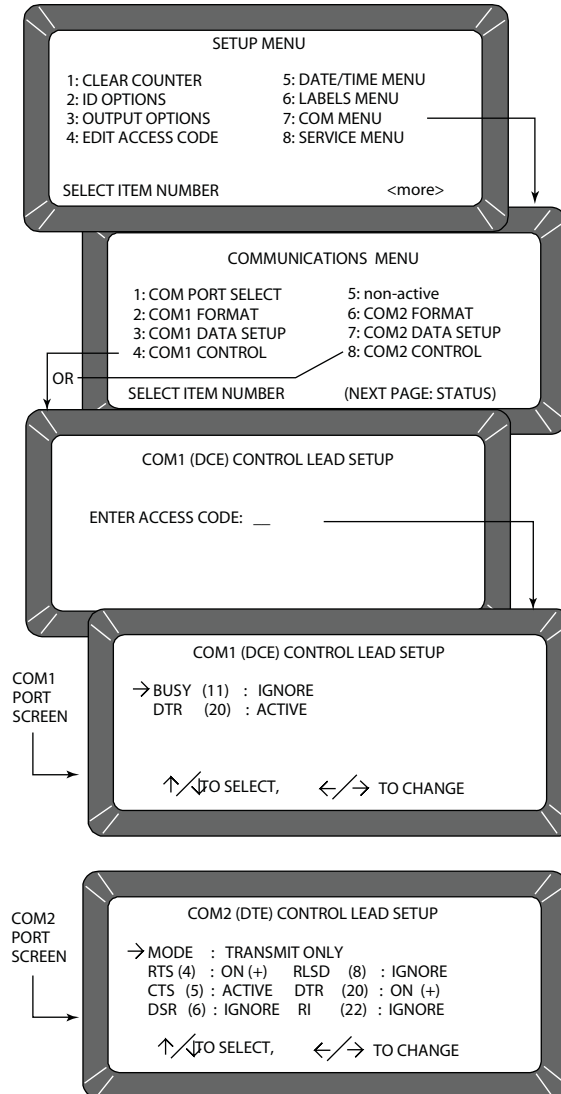

Figure 42
Definitions Of Common Acronyms

BUSY	– Line busy	DTR	– Data Terminal Ready
CTS	– Clear To Send	RI	– Ring Indicator
DCE	– Data Communications Equipment	RLSD	– Receive Line Signal Detect
DSR	– Data Set Ready	RTS	– Request To Send
DTE	– Data Terminal Equipment	RxD	– Receive Data
		TxD	– Transmit Data



NON-ACTIVE (5 Key from **Communications** menu)

The non-active selection (refer to Figure 37) has no function and only emits a long beep when depressed. No other action results.

SERVICE MENU (8 KEY)

The **Service** menu contains individual unit calibration constants and is accessed by DICKEY-john trained and equipped service personnel.

QUICK KEYS MENU

QUICK KEYS makes changing between frequently used grains easier during moisture measurements by bypassing the **Select Grain** menu. Up to three frequently used grains may be programmed for keyboard keys 1, 2, and 3. The desired key (grain) changes the grain to be tested whenever the **Press Load To Begin** screen appears just prior to starting the moisture measuring cycle.

To program a Quick Key:

1. Press the 4 key (**Setup** menu) from the **Main** menu and then the **Next Page** key to access PAGE 2 of the **Setup** menu.
2. Press the 1 key to choose the **Quick Keys** menu. Three choices are available (refer to Figure 43).
3. Select 1, 2 or 3 to program as a Quick Key. The **Enter Access Code** screen will appear.
4. Enter the access code and press the **Enter** key. The **Program Quick Key** screen will appear.
5. Use the **Left/Right Arrow** keys to select the desired grain. The grain name and the number to the right will change with each key stroke. Keep advancing until the correct grain is located. When the end is reached, the list wraps around to the beginning and starts again.
6. Press the **Previous Page** key to accept the selection.
7. Repeat the process to program or change each Quick Key as desired.



Next Page Key



Enter Key

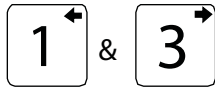

Left and Right Arrow Keys



Previous Page Key



Figure 43
Programming The Quick Keys

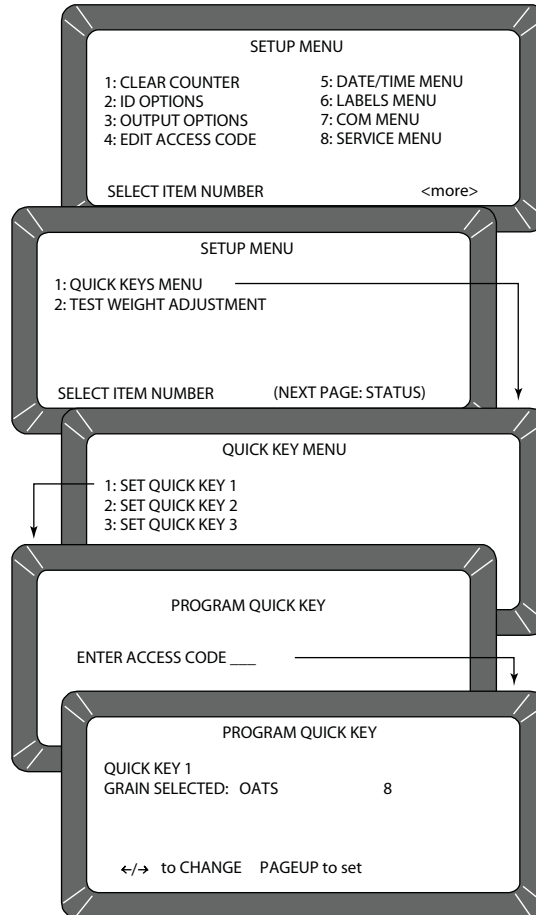

TEST WEIGHT ADJUSTMENT MENU

The test weight adjustment allows entering a correction factor for differences between the GAC 2100b grain test weight and the official test weight method. An offset value may be introduced by authorized personnel.

To change the offset value:

1. Press the 4 key (**Setup** menu) from the **Main** menu and then the **Next Page** key to access PAGE 2 of the **Setup** menu.
2. Press the 2 key to choose TEST WEIGHT ADJUSTMENT. The **To Proceed** screen appears with the message UNSEAL ACCESS PORT ON REAR PANEL AND DEPRESS WHITE PUSH BUTTON. The grain name, its number, and the current offset value displays starting with grain number 1 (refer to Figure 44).
3. Use the **Left/right Arrow** keys to select the grain type for correction. The grain name and its number to the right change with each key stroke. Advance until the correct grain is displayed. If the end of the list is reached, the list will wrap around to the beginning and start again.



Next Page Key

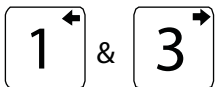

Left and Right Arrow Keys



Enter Key

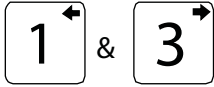

Left and Right Arrow Keys

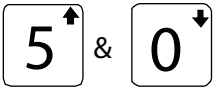

Up and Down Arrow Keys



Previous Page Key

NOTE: When a grain measurement is taken, an asterisk appears in front of the test weight value if the test weight option is enabled and a test weight offset has been applied. All changes to the test weight bias are recorded in the Audit Trail.

4. When the correct grain is found, press the **Enter** key. The final screen will appear for editing the TEST WEIGHT OFFSET value. The adjustment consists of two settings– the whole number and the tenths.
5. Select either the tenths or the whole number field with the **Left/Right Arrow** keys.
6. Change the selected value with the **Up/down Arrow** keys. The value of the number is monitored on the TEST WEIGHT OFFSET line toward the bottom of the screen.
7. When finished, press the **Enter** key to accept the final offset value. An asterisk will appear next to the value to indicate the number is recorded. An asterisk will also appear next to the test weight value, along with the moisture value, if the test weight option is enabled and a test weight offset has been applied.
8. Press the **Previous Page** key twice to return to the **Setup** menu. When a grain measurement is taken, an asterick appears in front of the test weight value if the test weight option is enabled and a test weight offset has been applied. All changes to the test weight bias are recorded in the Audit Trail.

Figure 44

Setting The Test Weight Adjustment

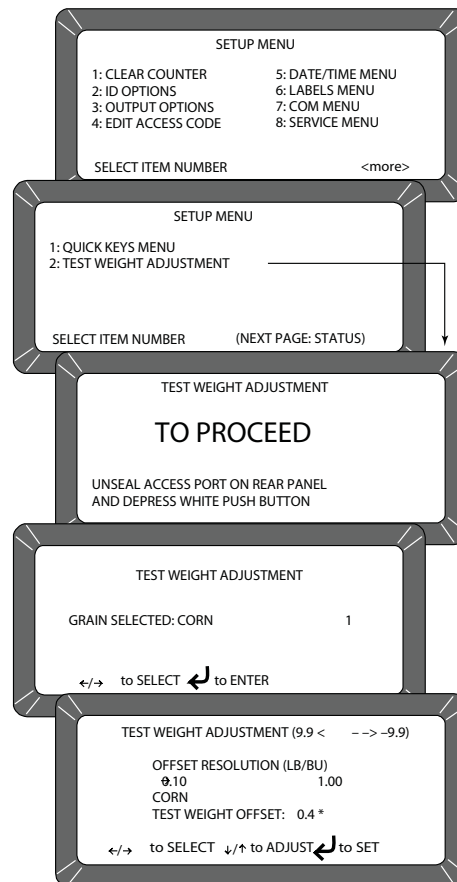





TEST UNIT PERFORMANCE

The **Tests** menu displays diagnostic tests and status information for operating values. The information is useful to technicians in evaluating overall performance and isolating problems. During normal operation, these are not generally referenced. However, problem identification can be assisted by reviewing certain values occasionally and observing changes. Most values may not be edited, but the contents may be printed for record retention. Also, while viewing the Factory Modes, earlier encountered errors stored in memory may be printed.

To access the **Tests** menu, press the 5 Key on the **Main** menu. The **Tests** menu will appear displaying eight choices (refer to Figure 45).

NON-ACTIVE KEYS

The 1 and 4 key selections (refer to Figure 45) are non-active and have no functions assigned. Pressing either key will only result in an audible beep.

Figure 45

Entering The Tests Menu

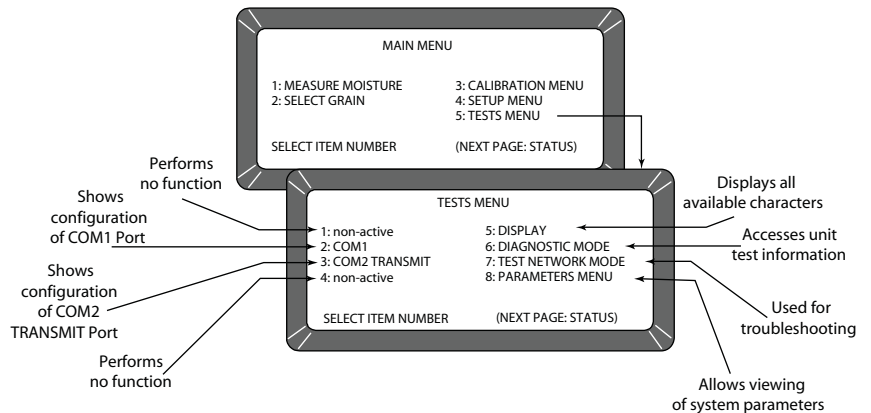

VIEW COM1 PORT (2 KEY)

The **COM1 Test** screen displays the configuration of the COM1 (communications) port. Values are set from the **SETUP** mode to match the driving device (i.e. printer) of the port.

To access the COM1 port:

1. Access the **COM1** Menu by pressing the 2 key on the **Tests** menu (refer to Figure 46). The **COM1 Test** screen will appear displaying the COM1 serial data setup status (Baud Rate, Data Bits, Parity, Stop Bits) on the left half of the screen. The COM1 control lead setup status is displayed on the right side showing the Buffer Status. The buffer line will indicate either **BUSY** or **EMPTY**.



Print Key



Previous Page Key

2. Verify that a printer is connected and press the **Print** key to print a sample of the entire TRANSMIT CHARACTER SET. When completed, press the **Previous Page** key to return to the **Tests** menu.

Figure 46

Entering The COM1 Test Menu

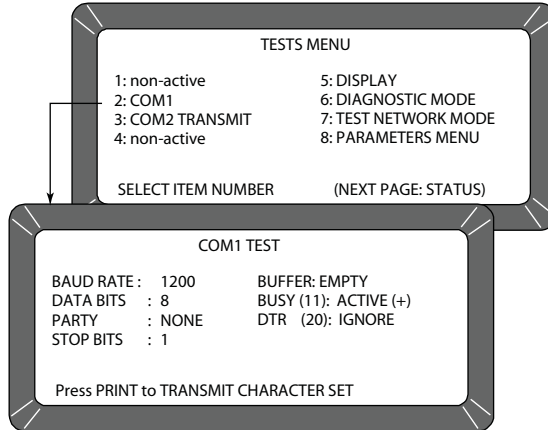

VIEW COM2 TRANSMIT PORT (3 KEY)

The **COM2 Transmit Test** screen displays the configuration of the COM2 TRANSMIT port. Values are set from the SETUP mode to match the communicating device (i.e. computer) of the port.

To configure the COM2 TRANSMIT port.

1. From the **Tests** menu, select COM2 TRANSMIT TEST using the 3 key (refer to Figure 47). The screen will display the COM2 Mode, Serial Data Setup (Baud Rate, Data Bits, Parity, Stop Bits), Buffer Status and the COM2 Control Lead Setup. If the buffer contains information, the line will indicate BUSY; otherwise EMPTY is indicated. Press the **Print** key to produce a printout of the character set through the COM2 port. Press the **Previous Page** key to return to the **Tests** menu.

Figure 47

Entering the COM2 Transmit Test Menu

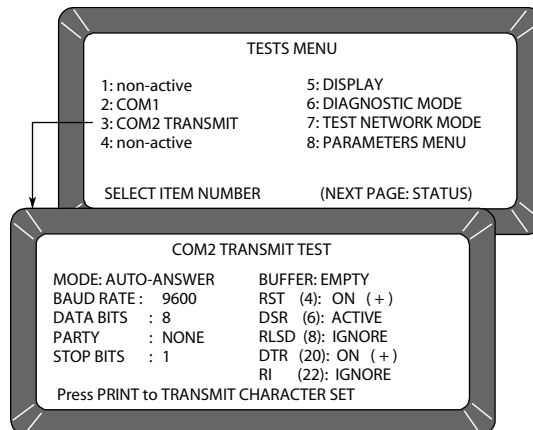



Previous Page Key

VIEW DISPLAY CHARACTERS (5 KEY)

The display screen allows the operator to view typical characters the unit is capable of producing for operator-generated messages (refer to Figure 48).

To access characters:

1. From the **Test** menu, press the 5 key to choose DISPLAY. The screen will show characters, symbols and digits that may be displayed by the unit. After viewing, press the **Previous Page** key to return to the **Tests** Menu.

Figure 48

Display Mode Screen

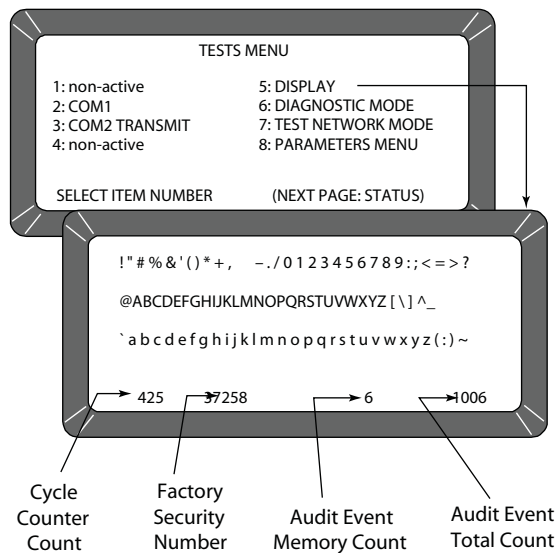

VIEW DIAGNOSTIC MODE (6 KEY)

The DIAGNOSTIC mode accesses unit operating values. Most of the readout values relate to the test cell circuitry.

To access diagnostic details:

1. Press the 6 key to enter DIAGNOSTIC mode (PAGE 1). Two pages of information are available (refer to Figure 49).
2. Choose the number key next to each selection, one key at a time. Each value calculates and is displayed next to the line title. If the printer is connected, a printout of each result is automatically printed (refer to Figure 50 for PAGE 1 printout and Figure 51 for PAGE 2 printout). The meaning of each line is as follows:
 - 1: **Vnull** - Null voltage from cell board.
 - 2: **Vtemp** - Temperature diode voltage from cell board.
 - 3: **Cwgt** - Counts from weight oscillator.
 - 4: **Ce/f** - Ratio of empty cell weight oscillator counts to full cell weight oscillator counts. When the 4 key is selected, item 3 blanks to recalculate. The message PLEASE WAIT followed by PLACE WEIGHT ON CELL THEN PRESS ENTER is displayed.



Enter Key

- A test weight is placed on top of the test cell and then the **Enter** key is selected. After a short wait, the results will be displayed.
- 5: SCD1** - D1 (conductivity) self-check - 379 ± 20 . When either the 5 or 6 key is selected, these two items calculate.
 - 6: SCD2** - D2 (capacitance) self-check- 2500 ± 20 .
 - 7: Temp** - Computed cell temperature in degrees C.

Figure 49
Diagnostic Mode Screens

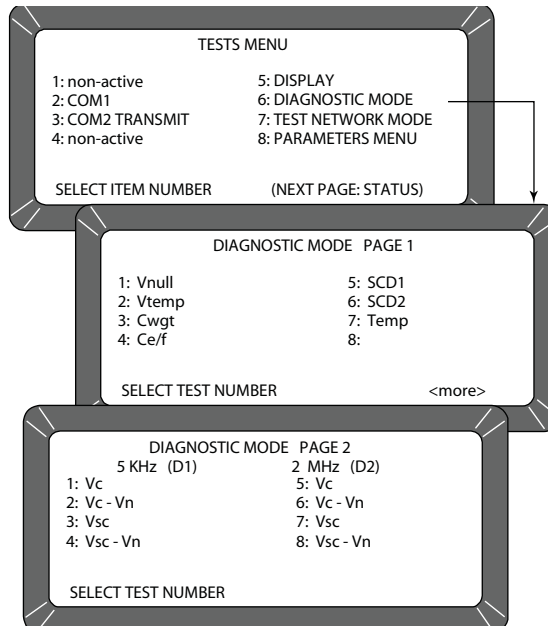

Next Page Key



Previous Page Key

3. Press the **Next Page** key to view PAGE 2 of the DIAGNOSTIC mode. The display screen is divided into two columns: 5 kHz and 2 MHz (refer to Figure 49).
 - **5 kHz (D1) – Left half of screen**
 - 1: Vc** - Voltage of 5 kHz oscillator.
 - 2: Vc-Vn** - Voltage of 5 kHz oscillator minus null voltage.
 - 3: Vsc** - Voltage of 5 kHz oscillator with on-board test network engaged.
 - 4: Vsc - Vn** - Voltage of 5 kHz oscillator with the on-board test network engaged minus null voltage.
 - **2 MHz (D2) – Right half of screen**
 - 5: Vc** - Voltage of 2 MHz oscillator.
 - 6: Vc - Vn** - Voltage of 2 MHz oscillator minus null voltage.
 - 7: Vsc** - Voltage of 2 MHz oscillator with on-board test network engaged.
 - 8: Vsc - Vn** - Voltage of 2 MHz oscillator with on-board test network engaged minus null voltage.

When finished, press the **Previous Page** key twice to return to the **Tests** menu.



Figure 50

Diagnostic Mode Printout Of Page 1

VNULL:	0,0496
VTEMP:	1,1838
CWGT:	38908
CE/F:	1,05377
S/N:	0261-2360
SCD1:	378
SCD2:	2499
NEC:	0,04941
KEC:	1,50218
KSC:	1,22889
MEC:	1,40597
MSC:	0,43373
TEMP:	18,26

Figure 51

Diagnostic Mode Printout Of Page 2

5 KHZ VC:	1,5024
5 KHZ VC-VN:	1,4528
5 KHZ VSC:	1,2291
5 KHZ VSC-VN:	1,1795
2 MHZ VC:	1,4943
2 MHZ VC-VN:	1,4446
2 MHZ VSC:	0,4416
2 MHZ VSC-VN:	0,3920



Load Key

TEST NETWORK MODE (7 KEY)

This mode is used by trained, authorized personnel in troubleshooting. The screens and printout are shown for reference only.

To access the TEST NETWORK:

1. Press the 7 key - TEST NETWORK mode (refer to Figure 52). The **Please Wait** screen will appear, followed by the **Press Load To Begin** screen.
2. Press the **Load** key to start the measuring cycle. When the test is completed, the results will be displayed and will print automatically if a printer is connected (refer to Figure 53).



Figure 52
Displaying Test Network Mode Results

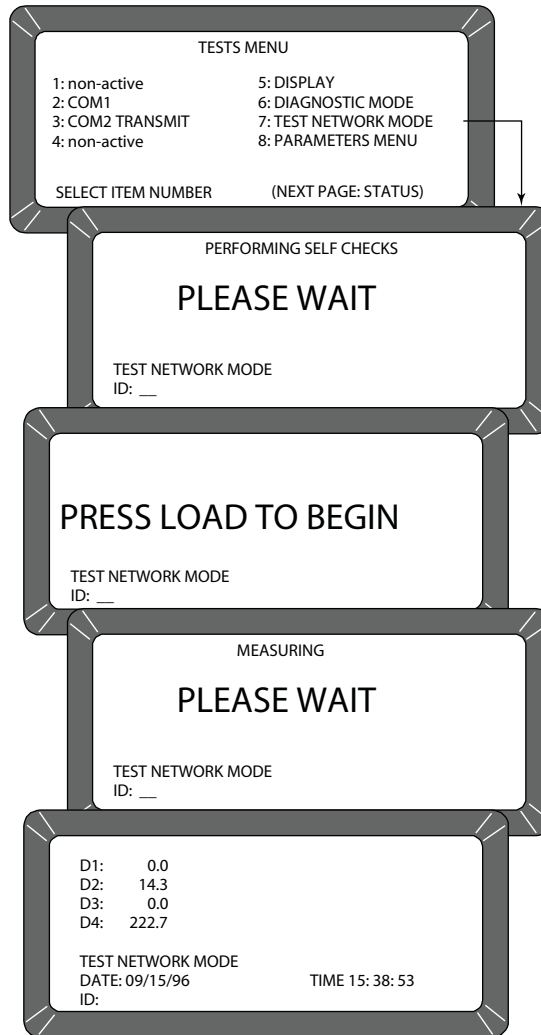



Figure 53

Printout Of Test Mode

DICKEY-JOHN, CORP.GAC2100	
05/18/96	09:18:59
ID:	
NF:	490
NE:	490
D1:	0,0
D1CF:	15000
D1CE:	15000
D2:	14,4
D2CF:	14853
D2CE:	14853
D3:	0,0
D4:	204,3
D4TF:	20,43
D4TE:	20,39
SELECT TEST NUMBER	

VIEW/PRINT PARAMETERS (8 KEY)

The **Parameters** menu (8 key) operates similarly to the **Service** menu, located under the **Setup** menu. The major difference is the inability to edit values in these screens. However, the **View Factory Mode** screen is useful in viewing the number of currently stored errors in memory.

To view the **Parameters** menu:

1. Choose the **Parameters** menu by pressing the 8 key from the **Tests** menu (refer to Figure 54). This menu allows the operator to view the unit parameters.
2. To print the values shown on the screen, select any menu, followed by the **Print** key. A printout of all the screens results (refer to Figure 55). Item 6 also prints all stored errors.
3. When finished viewing the screens, press the **Previous Page** key to return to the **Tests** menu.



Print Key



Previous Page Key



Figure 54
Viewing Parameters Menu

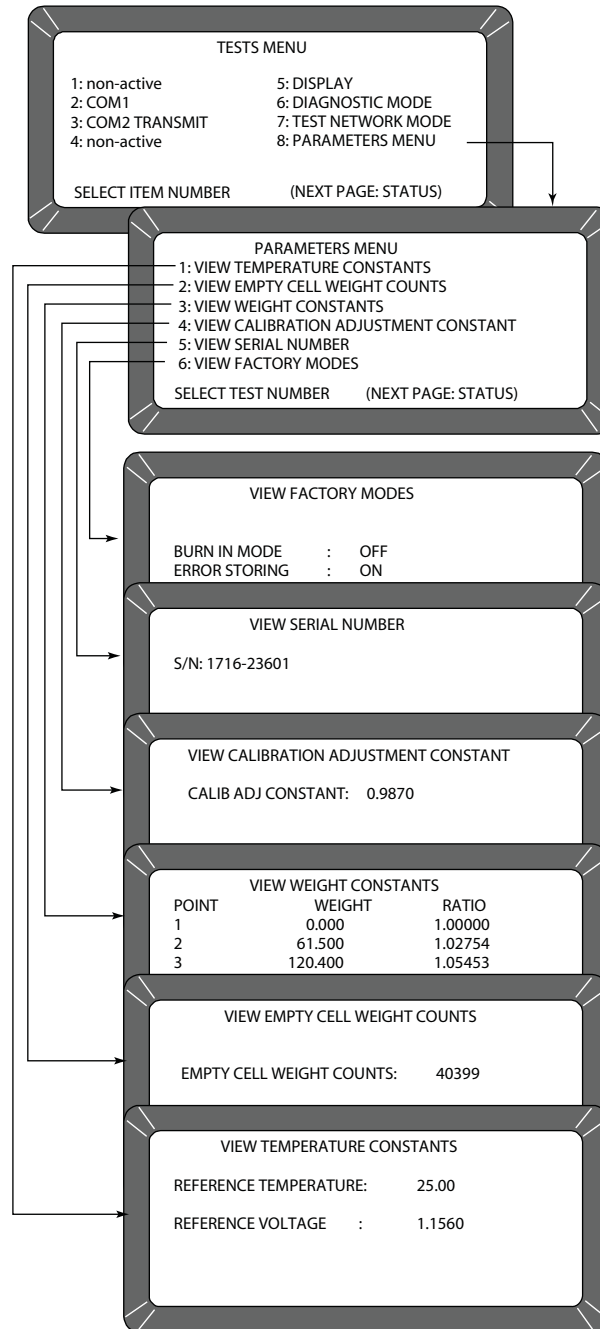



Figure 55

Printout Of Parameters Values

```
05/18/96      09:59:59
S/N:      1716-23601
REF TEMP:      25,00
REF VOLT:      1,1560
EC COUNT:      40399
WEIGHT TABLE:
1   0,000      1,00000
2   61,500     1,02754
3  120,400     1,05453
4  181,800     1,08340
5  240,600     1,11179
6  300,300     1,14108
CAC:      1,0000
IC:      1122
BURN IN MODE:  OFF
ERROR STORING: ON
CURRENT ERRORS
=====
ERROR 2
05/04/96 18:42:2
05/17/96 16:50:4
   5
50134
SELECT TEST NUMBER
```

OPERATOR'S MANUAL





OPERATOR MAINTENANCE

CELL CLEANING - DAILY



Load Key



Unload Key



Previous Page Key

1. From the **Main** menu, press the 5-key to display the **Tests** menu. Then press the 6-key to display the **Diagnostics** menu.
2. When the **Diagnostics** menu is displayed, press the **Load** key. The hopper doors will open and remain open until the **Unload** key is pressed.
3. Use the brush supplied in the accessory kit to clean the inside of the grain cell.
4. Slide the GAC 2100b to the front of the worktable and remove the grain drawer. Reach inside and very carefully clean the strike-off arm spring.

CAUTION

Before performing Step 5, ensure that all fingers or other foreign objects are not in cell area.

5. Press the **Unload** key. The cell will rotate 180 degrees to dump the residue from the cell cleaning procedure. The hopper doors will close. Pressing the **Previous Page** key twice will return the display to the **Main** menu.

FUSE REPLACEMENT

1. Disconnect the line cord from the rear of the unit. Using a small-bladed screwdriver or similar tool, remove the cover and fuse block assembly.
2. Replace the blown fuse with a 1 Amp Slo-Blo fuse (Fuse Size = 5mm (0.197") dia. x 20 mm (0.787") long).
3. Reinstall fuse block assembly and cover.

Figure 56

Fuse Block Assembly

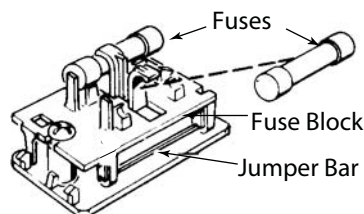

OPERATOR'S MANUAL





ERROR CODES

The GAC 2100b contains a microprocessor to control the grain sample measurements and self-checks to determine the integrity of the internal electronics. If any limit is exceeded or malfunctions occur an error code displays.

Error	Probable Cause	Corrective Action
1	The empty cell self -check reading is out of limits.	Dump the cell and ensure it is empty.
2	The empty cell weight reading is out of limits.	Dump the cell and ensure it is empty.
3	The unload mechanism has malfunctioned.	Check the cell position and ensure it is free to operate.
4	The strike-off mechanism has malfunctioned.	Check drawer and press the Unload key. Ensure the cell and strike-off arm are free to operate.
5	An invalid calibration is referenced.	Reselect the same grain or select a new grain and retry. If the condition continues to occur, contact DICKEY-john Service Department at 1-800-637-3302.
6	The moisture reading exceeds the upper limit.	Select a new grain and retry.
7	The moisture reading exceeds the lower limit.	Select a new grain and retry.
8	The empty cell ambient temperature has exceeded its limit.	Allow the GAC 2100b to reach normal operating temperature.
9	The sample temperature exceeds its limit.	Allow the sample to either cool down or warm up, then retry.
10	The difference in temperature between empty cell ambient and full cell condition exceeds its limits.	Change the appropriate conditions and retry.
11	Test weight exceeds stored average bulk density value by more than +20 percent or -30 percent.	Use a more representative sample.
12	A system memory error occurred.	Turn the power OFF for at least 5 seconds; power system back ON. If the condition continues, contact DICKEY-john Service Department at 1-800-637-3302.
13	An on-board RAM memory error has occurred.	Turn the power OFF for at least 5 seconds; turn power system back ON. If the condition continues, contact DICKEY-john Service Department at 1-800-637-3302.
14	A load operation cannot be initiated for NTEP calibrations approved for test weight display if the hopper is not full.	Fill the hopper so that the hopper sensor optical path is blocked; then proceed.
15	The real-time clock battery is faulty.	Contact DICKEY-john Service Department at 1-800-637-3302.

OPERATOR'S MANUAL





APPENDIX A: COMMUNICATION PORTS

COM1 PORT OPTIONS

The COM1 Port (refer to Table 2) is a serial port conforming to the EIA/TIA RS-232-E standard and configured as Data Communication Equipment (DCE). Data out is RS-232-E levels and parity with adjustable Format, Data Setup and Control.

Function	Option	Hex
Output Format	PRN 20 PRN 80 TST 20 PRN 81 CSV 01 PRN 21	
Line Terminator	LF (Line Feed) CR (Carriage Return) LF + CR CR + LF	0A 0D 0A, 0D 0D, 0A
Data Setup Baud Rate	300 600 1200 2400 4800 9600 19200	
Control Busy	Ignore Active (+) Active (⊘)	
Control DTR	Ignore Active	

COM1 PIN ASSIGNMENT DETAILS

COM1 (refer to Table 3) is configured as Data Communication Equipment (DCE).

Protective Ground (pin 1) – Electrically connected to frame.

Received Data (pin 3) – Transmitted data from the GAC 2100b.

Data Set Ready (pin 6) – ON (positive voltage) whenever the GAC 2100b is powered.

Signal Ground (pin 7) – Common reference for all other COM1 signals.

Received Line Signal Detector (pin 8) – ON (positive voltage) whenever the GAC 2100b is powered.

Busy (pin 11) – Gates the transmission of data from the GAC 2100b. The **COM1 Control Lead Setup** screen may be configured ACTIVE (+), ACTIVE (–) or IGNORE. When the line is inactive, up to 2048 characters are buffered. If not connected, configure this line as IGNORE.



Data Terminal Ready (pin 20) – Indicates the connected device is not available. The **COM1 Control Lead Setup** screen configures this line as ACTIVE or IGNORE. If configured ACTIVE, an OFF condition (negative or zero voltage) inhibits the transmission of data from the GAC 2100. Results display but are not buffered for output on COM1. If not connected, this line should be configured as IGNORE.

Pin Number	Designation	Signal Name	Direction
1	AA	Protective Ground	NA
3	BB (RxD)	Received Data	To Device
6	CC (DSR)	Data Set Ready	To Device
7	AB	Signal Ground	NA
8	CF (RLSD)	Received Line	To Device
11		Signal Detector Busy	To GAC 2100
20	CD (DTR)	Data Terminal Ready	To GAC 2100

Function	Option	Hex
Output Format	PRN 20 PRN 80 TST 20 PRN 81 CSV 01 PRN 21	
Line Terminator	LF (Line Feed) CR (Carriage Return) LF + CR CR + LF	0A 0D 0A, 0D 0D, 0A
Data Setup Baud Rate	300 600 1200 2400 4800 9600 19200	
Data Bits	7 or 8	
Parity	None, Even or Odd	
Stop Bits	1 or 2	
Control MODE	Transmit Only Auto Answer	
Control RTS	On (+) Auto	
Control DSR	Ignore Active	

COM2 PIN ASSIGNMENT DETAILS

COM2 (refer to Table 5) is configured as Data Terminal Equipment (DTE).

Protective Ground (pin 1) – Electrically connected to frame.

Transmitted Data (pin 2) – Data is transmitted from this pin.

Received Data (pin 3) – Data is received on this pin.



Request To Send (pin 4) – Configured ON (positive voltage) whenever unit is powered or to be ON (positive voltage) only when there is data in the COM2 buffer to be transmitted. Use the **COM2 Control Lead Setup** screen to configure this line.

Clear To Send (pin 5) – Gates transmission of data from the GAC 2100. This line must be ON (positive voltage) to obtain data on COM2. If an appropriate signal is not available from the connected device, connect this pin directly to REQUEST TO SEND (pin 4). When the line is inactive, up to 2048 characters are buffered.

Data Set Ready (pin 6) – Notifies the GAC 2100 that the connected device is not available. The **COM2 Control Lead Setup** screen configures this line as active or ignored. If configured as ACTIVE, an OFF condition (negative or zero voltage) inhibits the transmission of data from the GAC 2100. Results display but are not buffered for output on COM2. If not connected, this line should be configured as IGNORED.

Signal Ground (pin 7) – Common ground reference for all other COM2 signals.

Received Line Signal Detector (pin 8) – Currently not used.

Data Terminal Ready (pin 20) – ON (positive voltage) whenever the GAC 2100 is powered.

Ring Indicator (pin 22) – Currently not used.

Pin Number	Designation	Signal Name	Direction
1	AA	Protective Ground	NA
2	BA (TxD)	Transmitted Data	To Device
3	BB (RxD)	Received Data	To GAC 2100
4	CA (RTS)	Request To Send	To Device
5	CB (CTS)	Clear To Send	To GAC 2100
6	CC (DSR)	Data Set Ready	To GAC 2100
7	AB	Signal Ground	NA
8	CF (RLSD)	Received Line to Signal Detector	To GAC 2100
20	CD (DTR)	Data Terminal Ready	To Device
22	CE (RI)	Ring Indicator	To GAC 2100





APPENDIX B: AUTOMATIC HOPPER SENSING

Unlike earlier GAC 2100 models, the GAC 2100b has the added capability of measuring and displaying TEST WEIGHT (DENSITY). For NTEP APPROVED FOR TEST WEIGHT CALIBRATIONS, this is accomplished by using an extended hopper and an optical FULL HOPPER sensor that ensures the amount of grain in the hopper is sufficient to overfill the measurement cell.

Figure 57

Full Hopper Sensor

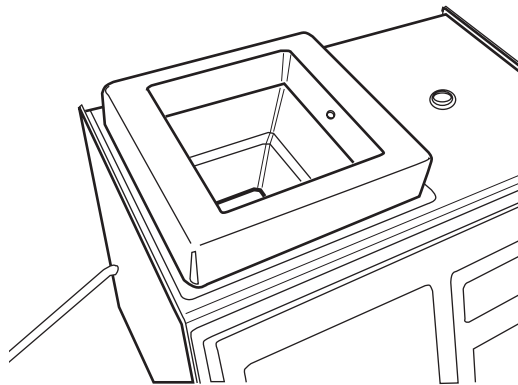

An approximate test weight is also available for non-NTEP calibrations but will be displayed and printed as APPROX DENSITY. The hopper sensor is not used for these measurements.

HOPPER FULL SENSOR OPERATION

When the FILL HOPPER instruction is given, fill the hopper to a level that blocks the optical light path of the hopper sensor. Press the **Load** key. If the grain level is adequate, the machine will continue through the measurement cycle and display the results.

If the grain level was not blocking the optical path of the hopper sensor when the **Load** key was pressed, an ERROR 14 will be displayed, indicating that the hopper is not full (refer to Figure 58). Continue filling the hopper to the correct level and press the **Load** key again. The machine will again attempt to initiate a measurement cycle. If an adequate amount of grain is not available to complete a measurement, the sample may be dumped by pressing the **Unload** key. This will dump the sample into the drawer of the drawer and the measurement cycle will be terminated. The machine is now ready for the next operation.

The HOPPER SENSOR may also be used for automatic operation with a remote computer. Complete operating instructions for the automatic feature are described in a separate Communications Software Manual. Contact the DICKY-john Service Department for additional information.



Figure 58

Error 14

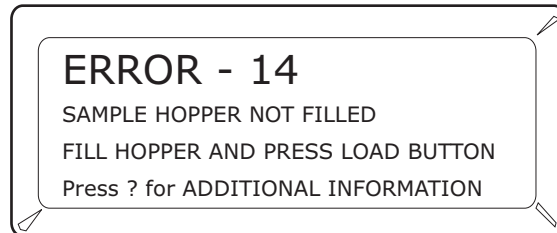

Dealers have the responsibility of calling to the attention of their customers the following warranty prior to acceptance of an order from their customer for any DICKEY-john product.

DICKEY-john® WARRANTY

DICKEY-john warrants to the original purchaser for use that, if any part of the product proves to be defective in material or workmanship within one year from date of original installation, and is returned to DICKEY-john within 30 days after such defect is discovered, DICKEY-john will (at our option) either replace or repair said part. This warranty does not apply to damage resulting from misuse, neglect, accident, or improper installation or maintenance; any expenses or liability for repairs made by outside parties without DICKEY-john's written consent; damage to any associated equipment; or lost profits or special damages. Said part will not be considered defective if it substantially fulfills the performance expectations. THE FOREGOING WARRANTY IS EXCLUSIVE AND IN LIEU OF ALL OTHER WARRANTIES OF MERCHANTABILITY, FITNESS FOR PURPOSE, AND OF ANY OTHER TYPE, WHETHER EXPRESS OR IMPLIED. DICKEY-john neither assumes nor authorizes anyone to assume for it any other obligation or liability in connection with said part and will not be liable for consequential damages. Purchaser accepts these terms and warranty limitations unless the product is returned within fifteen days for full refund of purchase price.

**For DICKEY-john Service Department, call
1-800-637-3302 in either the U.S.A. or Canada**



Headquarters:

5200 Dickey-john Road, Auburn, IL USA 62615

TEL: 217 438 3371, FAX: 217 438 6012, WEB: www.dickey-john.com

Europe:

DICKEY-john Europe S.A.S, 165, boulevard de Valmy, 92706 – Colombes – France

TEL: 33 (0) 1 41 19 21 80, FAX: 33 (0) 1 47 86 00 07 WEB: www.dickey-john.eu