



# GAC<sup>®</sup> 2500 GRAIN ANALYSIS COMPUTER

MODEL GAC 2500 (INTL/C)





<b>Safety Notices</b> .....	<b>1</b>
Disclaimer .....	1
<b>Introduction</b> .....	<b>3</b>
Accessories .....	3
Unit Overview .....	3
Features .....	4
Specifications .....	4
Declaration of Conformity .....	4
External Communication Connections .....	5
Printer .....	6
<b>Quick Start Guide</b> .....	<b>7</b>
Step 1: Unlock Shipping Brackets .....	7
Step 2: Instrument Placement .....	8
Step 3: Leveling Instrument .....	8
Step 4: Initial Setup .....	8
Step 5: Begin Grain Analysis .....	9
Step 6: Select a Product .....	9
Step 7: Perform a Grain Analysis .....	10
<b>Physical Instrument Setup</b> .....	<b>11</b>
Unlock Shipping Brackets .....	11
Instrument Placement .....	14
Leveling Instrument .....	14
<b>Security</b> .....	<b>15</b>
OEM Password .....	16
<b>Installation</b> .....	<b>17</b>
Connecting AC Power .....	17
Grain Drawer .....	18
Optional Bottomless Grain Drawer .....	18
<b>Initial Setup</b> .....	<b>19</b>
<b>Navigation</b> .....	<b>21</b>
Using External Devices .....	21
Touch Screen Button Functions .....	21
Home .....	21
Power Off .....	22
Initiate .....	22
Print .....	22
Back .....	22
Abort .....	22
Enter .....	22
USB .....	22
User .....	22
Instrument Information .....	22
LCD Display Touch Screen Calibration .....	22
Keypad .....	23
Clean .....	23
Region .....	23
Import Region .....	23
Delete Region .....	23



<b>Password Restrictions .....</b>	<b>25</b>
<b>Setup .....</b>	<b>27</b>
Product .....	27
Edit Existing Product .....	27
Edit Product .....	29
Create Product .....	30
Delete Product .....	31
Load New Product .....	32
Administrative Settings .....	34
To Change a Known User Name/Password .....	34
System Setup .....	35
Printer Setup .....	35
Adding a Header and Footer to Ticket .....	37
Streaming Data Serially .....	37
Printer/Scale Setup .....	38
Language and Keyboard Settings .....	39
Virtual Keyboard .....	39
Region .....	41
Import a Region .....	43
Import Regions at Product Screen .....	44
Delete a Region .....	44
Importing Existing Calibration/Region Files .....	45
Sample Setup .....	46
Result Setup .....	48
Export Data Format .....	50
Time .....	51
Units .....	52
Owner Data .....	53
Service Data .....	54
LCD Display Touch Screen Calibration .....	55
Clearing a Database .....	56
Check Scale .....	57
Network Setup .....	60
Update Instrument .....	61
<b>Startup .....</b>	<b>63</b>
Power Down .....	64
<b>Analyzing grain .....</b>	<b>65</b>
User Login (Optional) .....	65
User Login .....	66
User Log Off .....	66
Selecting Product .....	67
Region Change .....	68
Performing a Grain Analysis .....	68
Hopper Level Indicator .....	69
Region Mismatch Warning .....	73
Approximate Calibration Reading .....	74
General Cleaning Tip .....	74
Database Memory Messages .....	75
Database Memory Full Warning .....	75
Out of Memory .....	76
Data Drive Out of Memory .....	76



<b>Results</b> .....	<b>77</b>
Refine Query Options .....	78
Unable to Show Query Results .....	79
Audit Trail .....	80
View Products .....	82
<b>Grain Calibrations</b> .....	<b>83</b>
<b>Diagnostics</b> .....	<b>85</b>
<b>Maintenance</b> .....	<b>87</b>
External Cleaning .....	87
Internal Cleaning .....	88
Daily Clean Method .....	88
Extensive Cleaning Method .....	90
Cleaning the Temperature Sensor Probe .....	93
Temperature Sensor Type .....	94
<b>Troubleshooting</b> .....	<b>99</b>
Error Messages .....	99
<b>Warranty</b> .....	<b>107</b>

# OPERATOR'S MANUAL

---





## SAFETY NOTICES

Safety notices are one of the primary ways to call attention to potential hazards. An absence of specific alerts does not mean that there are no safety risks involved.



**This Safety Alert Symbol identifies important safety messages in this manual. When you see this symbol, carefully read the message that follows. Be alert to the possibility of personal injury or death.**

---

### **▲ WARNING**

Use of the word **WARNING** indicates a potentially hazardous situation which, if not avoided, could result in death or serious injury.

---

---

### **▲ CAUTION**

Use of the word **CAUTION** with the Safety Alert Symbol indicates a potentially hazardous situation which, if not avoided, may result in minor or moderate injury.

---

---

### **CAUTION**

Use of the word **CAUTION** without the safety alert symbol indicates a potentially hazardous situation which, if not avoided, may result in equipment damage.

---

## DISCLAIMER

DICKEY-john reserves the right to make engineering refinements or procedural changes that may not be reflected in this manual. Material included in this manual is for informational purposes and is subject to change without notice.



## LIABILITY

DICKEY-john designed the GAC<sup>®</sup> 2500 to measure oilseed and grain moisture content. We rigorously test and calibrate each instrument before it leaves the factory. Use of the instrument in the field, however, is subject to environmental and operating conditions beyond our control. **DICKEY-john disclaims all liability for damages resulting from environmental and operating conditions beyond our control and for any damages that might follow incorrect results due to those environmental or operational conditions.**

Therefore, we expect the operator to take responsibility to assure that the results of the testing is as accurate as possible by following approved maintenance procedures on a regular basis, by cleaning the instrument and its sensors on a regular and as-needed basis depending on the amount of dust, dirt, and debris encountered in the instrument's use, by monitoring performance using daily check samples, and by adhering to the check procedures set forth in the manual. As with any kind of sophisticated equipment, optimal results depend in part on proper cleaning and maintenance.

For questions concerning these issues, refer to the product warranty, or call your DICKEY-john representative.



## INTRODUCTION

The DICKEY-john Grain Analysis Computer GAC<sup>®</sup> 2500-INTL quickly tests grain and automatically calculates moisture content, temperature, and test weight (bulk density) of the sample. The unit prompts for sample loading, tests the sample, and displays the results.

## ACCESSORIES

The following list of components are included with the unit and can be ordered as replacement parts:

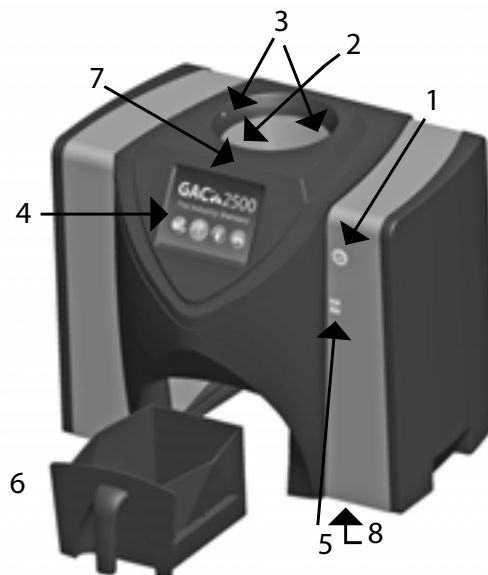
- 110V power cord p/n 203150002
- 220V power cord p/n 203150005
- Operator's manual p/n 11001-1655B
- Cleaning brush p/n 206410003
- Grain drawer p/n 468071541
- Grain drawer bottomless (optional) p/n 468071542

## UNIT OVERVIEW

1. Power (on/off) button
2. Hopper
3. Hopper full sensors
4. Touch screen display
5. USB connections (2) front (2) back
6. Sample drawer
7. Bubble level
8. Adjustment feet (4)

*Figure 1*

*GAC2500 Overview (Front of Unit)*







## FEATURES

- Color touch screen display guides users through testing and setup
- Easy-to-use user interface
- Fast, accurate grain analysis
- Alpha/numeric sample identification with the ability to add an optional extended keyboard or bar code reader via USB
- Error messages display when out-of-limits moisture, grain weight, or grain temperature occur
- Customizable work environment
- Optional password protection
- Long-term storage of grain tests
- Large storage to handle complete grain calibration library
- Internal memory capacity to handle future upgrades
- Printing capabilities
- A variety of external communication options

## SPECIFICATIONS

- Operating temperature: 36 to 113 degrees F (2 to 45 degrees C)
- Power: 110/220V, 50/60 Hz, 30/35 VA
- Humidity: 20 to 90% noncondensing
- Grain temperature: -4 degrees F to +113 degrees F (-20 degrees to +45 degrees C) depending on grain calibrations
- Storage/transit temperature: -4 to +140 degrees F (-20 to +60 degrees C)
- Moisture range: 5 to 45% (grain dependent)
- Approximate Weight: 25 lbs.
- Approximate dimensions: 17"H x 19"W x 14"D
- A USB memory device less than or equal to 2-4 GB in size formatted as FAT is recommended for extracting data from instrument

## DECLARATION OF CONFORMITY

The GAC<sup>®</sup> 2500 is in conformity with the provisions of the following directives and regulations:

- 2011/65/EU Restrictions of Hazardous Substances in Electrical and Electronic Equipment
- 2014/35/EU Low Voltage Directive
- 2014/30/EU EMC Directive
- EN61010-1-2010 Safety requirements for electrical equipment for measurement, control, and laboratory use operating at a maximum altitude of 6562 feet (2000 meters)
- IEC 61010-1:2010 (3rd Edition)
- ANSI/UL61010-1 /CAN/CSA - C22.2 NO. 61010-1 (3rd Edition)

### EMC

EMC conformity to EN 61326-1:2013 (Electrical Equipment for Measurement, Control, and Laboratory use)



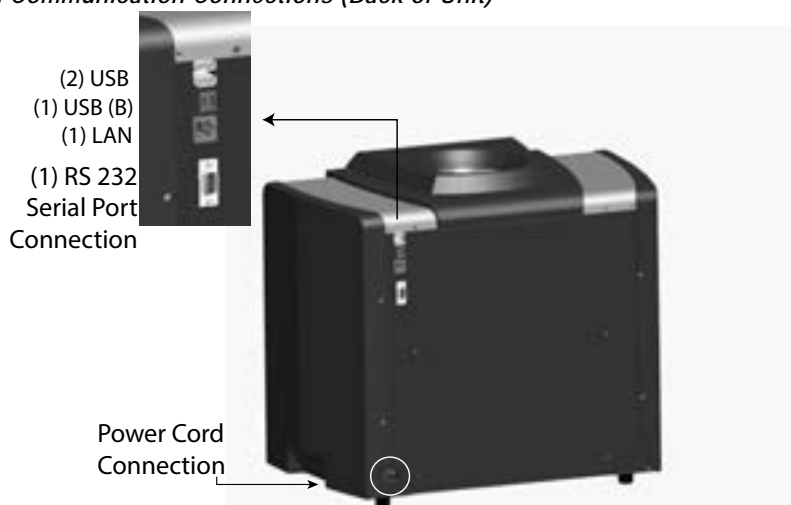
*NOTE: A USB memory device less than or equal to 2-4 GB in size formatted as FAT is recommended for extracting data from instrument*

## EXTERNAL COMMUNICATION CONNECTIONS

- 4 USB connections (2 in front, 2 in back) to connect a keyboard, mouse, printer or flash drive. Up to 3 devices can be active on USB.
- 1 USB connection to connect the GAC® 2500 to a PC for downloading of software to the device, installing calibrations, or remotely accessing data from the instrument.
- 1 ethernet connection to connect the GAC® 2500 to a PC or network for downloading of software to the device, installing calibrations, or remotely accessing data from the instrument.
- 1 RS232 serial port printer connection

*Figure 2*

*External Communication Connections (Back of Unit)*



### **CAUTION**

**Appropriate space must be left around the input power connector to allow easy disconnection at the unit.**

---



## PRINTER

An optional printer that is RS232 compatible or a USB printer that supports Printer Control Language (PCL) can connect to the GAC<sup>®</sup> 2500 to print test data results to a ticket. The ticket can be setup to include the facility name and address, product, date and time, sample ID, customer ID, grain calibration date, percent moisture, grain temperature, test weight, and errors. The data can be automatically printed at the end of each measurement cycle or manually initiated by pressing the **Printer** button.

*Figure 3*

*Printer*

---





## QUICK START GUIDE

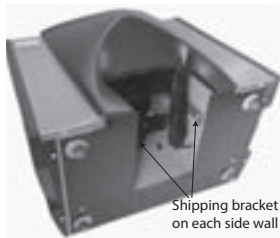
This section details the basic steps of setup and analyzing using the GAC 2500 INTL instrument. Refer to other sections of this manual for more detailed instructions.

### STEP 1: UNLOCK SHIPPING BRACKETS

Two shipping brackets must be unlocked prior to setup and operation.



1. Remove the Allen wrench from upper foam insert.



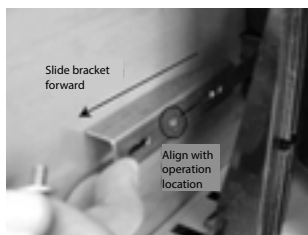
2. Remove grain drawer and place unit on backside to locate shipping brackets on the left and right side walls. **IMPORTANT: Be careful when placing unit on backside to avoid damage to security switch.**



3. Loosen and then remove hex bolt.



4. Press down on the bracket to release.



5. Slide bracket forward and align with operation location.



6. Insert hex bolt into operating location hole and tighten using the Allen wrench.
7. Perform the same procedure to the other bracket.
8. Once both brackets are tightened to the operating location, place unit upright.

## STEP 2: INSTRUMENT PLACEMENT

- Place instrument in a clean environment protected from rapid changes in ambient temperature and vibration.
- A flat, level surface that does NOT exceed more than 1 degree of tilt (left to right and front to back) is required.
- Surface should be vibration free.

## STEP 3: LEVELING INSTRUMENT

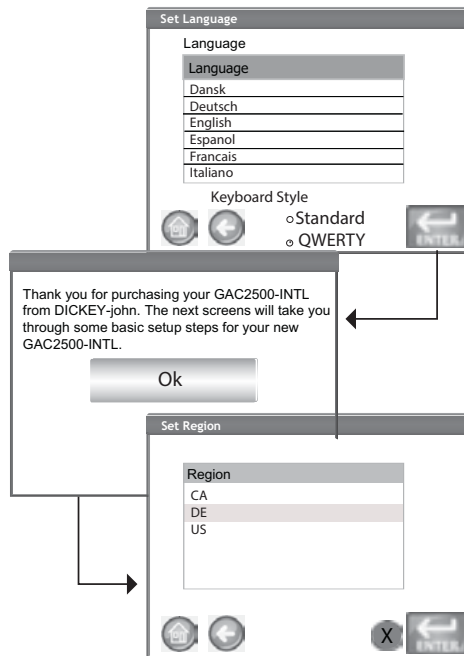
A bubble level located on the top surface aids in leveling the instrument for optimum test weight measurement.

- Adjust the feet (4) on instrument bottom until bubble is in the center of the level.

## STEP 4: INITIAL SETUP

When powered on for the first time, the instrument will force the selection of the desired region and language. These screens automatically appear.

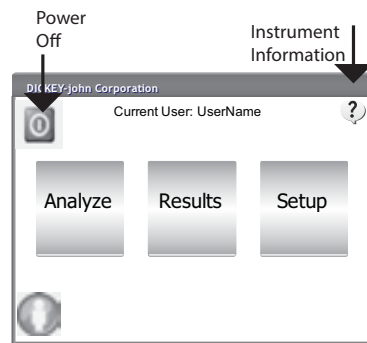
**NOTE:** This step does not occur after initial setup but both screens are available by pressing the **System** button and selecting the Region and/or Language buttons.



1. Highlight the desired Language press **Enter**.
2. Press **OK** button.
3. Highlight the Region and press **Enter**.
4. The instrument will proceed with setup and then proceed to Main Menu.



## STEP 5: BEGIN GRAIN ANALYSIS

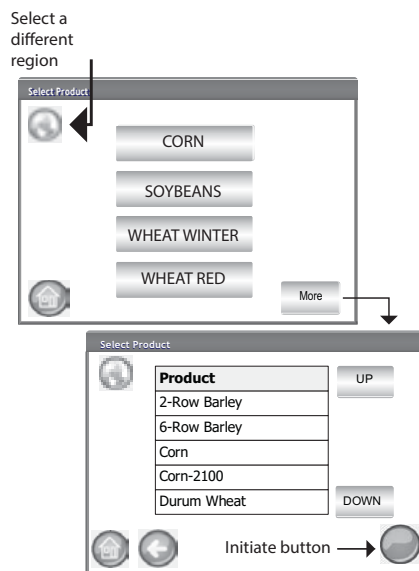


The Main Menu screen appears after all Startup screens have loaded. This is the “Home” menu through which all other menus are accessed.

1. Press the **Analyze** button to begin product selection.

## STEP 6: SELECT A PRODUCT

*NOTE: If User ID is enabled, it must be entered before analysis can occur. Refer to Analyzing Grain section (Figure 53).*



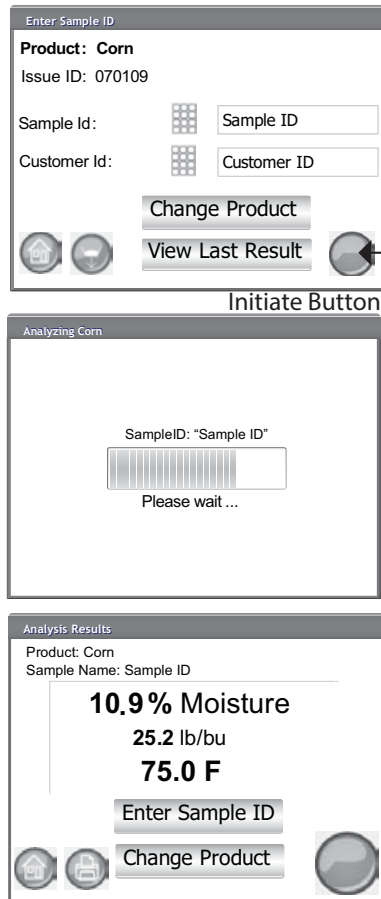
### To Select a Grain for Testing:

1. A pre-defined list of 4 grains appear on the Select Product screen.
  - Grains are saved in a “last used” order.
  - A grain selected on the first Select Product screen proceeds to Sample ID screen or the Analysis screen.
2. To view additional grains not viewable on the top level Select Product screen, press the **More** button.
  - Press the **Up** and **Down** buttons to view grains.
  - Select the desired grain in the product table.
  - Once selected, press the **Initiate** button to accept.
3. Grain is ready for analysis.



## STEP 7: PERFORM A GRAIN ANALYSIS

**NOTE:** *Drawer capacity holds approximately 3 tests. After 3 tests the drawer must be emptied before proceeding.*



1. If enabled, the Enter Sample ID screen appears. The selected product and Issue ID displays at the top of the screen.

–**Change Product** button allows selection of a different product.

–**Dump** button dumps product from the hopper.

2. A Sample ID name can be entered by pressing the keypad located next to the input box.

3. A Customer ID can be entered by pressing the keypad located next to the input box.

4. Press the **Initiate** button to proceed.

5. Pour grain into the hopper heaping grain slightly up to the hopper full sensors.

6. Press the **Initiate** button (green) to begin test. Grain dumps into the measurement cell from the hopper. A test will only perform when the **Initiate** button is green.

7. The cell fills and the striker arm swings across the top of the test cell to wipe away excess grain.

8. During analysis, a testing status bar indicates progress.

9. An audible alarm indicates when test is complete and automatically advances to the Analysis Results screen.
10. The Analysis Results screen displays:
  - Product tested
  - Sample name
  - Moisture content % (\* indicates certified)
  - Test Weight lbs/bu or kg/hl (optional) (\* indicates certified)
  - Temperature (optional)



## PHYSICAL INSTRUMENT SETUP

### UNLOCK SHIPPING BRACKETS

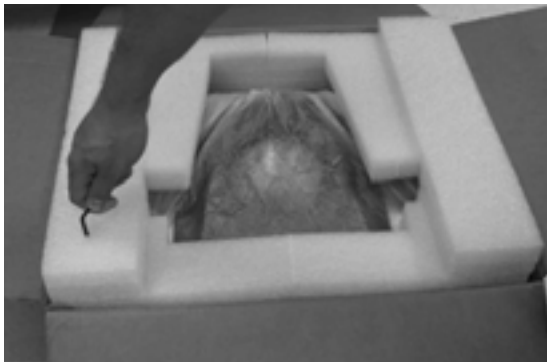
The GAC<sup>®</sup> 2500 instrument contains (2) shipping brackets that secure the measurement cell during shipping. After unpacking the instrument, the shipping brackets must be unlocked and placed in the operating location before proceeding to setup and operation.

#### To unlock shipping bracket:

1. Remove Allen wrench from upper foam packaging insert.

*Figure 4*

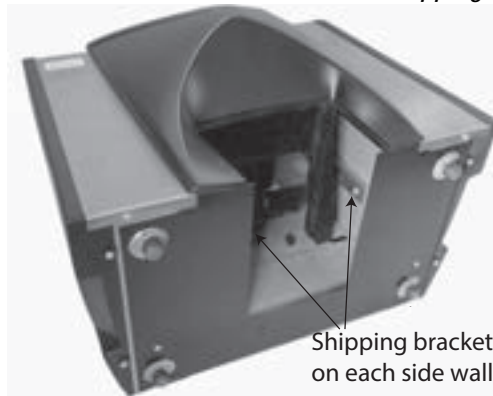
*Remove Allen Wrench*



2. Carefully remove unit from packaging and place on a flat, sturdy surface.
3. Remove grain drawer and set aside.
4. Place unit on its backside. **IMPORTANT: Be careful when placing unit on back to avoid damage to security switch.** Shipping brackets are located on the left and right side wall.

*Figure 5*

*Remove Grain Drawer and Locate Shipping Brackets*



5. Loosen hex bolt from the shipping locked location.





*Figure 6*

*Loosen Hex Bolt from Bracket*



6. Remove hex bolt and set aside.

*Figure 7*

*Remove Hex Bolt*



7. Press down on the bracket to release.

*Figure 8*

*Press Down on Bracket*

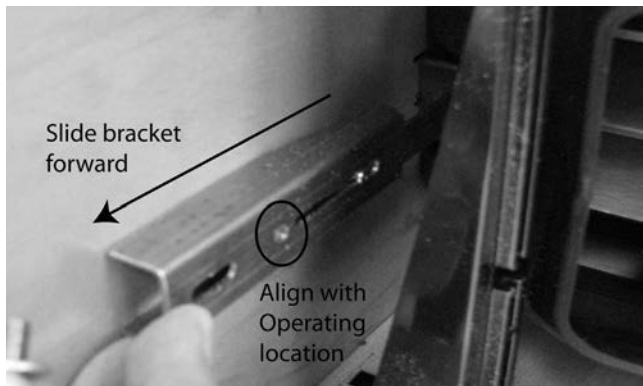




8. Slide bracket forward and align with operating location.

*Figure 9*

*Slide Bracket Forward*



9. Insert hex bolt into operating location hole and securely tighten using the Allen wrench.

*Figure 10*

*Insert Hex Bolt and Tighten*



10. Perform the same procedure to the other bracket.
11. Once both brackets are securely tightened to the operating location, place unit upright.

**IMPORTANT: If for any reason this unit is shipped or transported, the hex bolts should be removed from the operating location and secured back to the shipped locked location to protect the measurement cell during transit!**



## INSTRUMENT PLACEMENT

Place the instrument in a clean environment that is protected from rapid changes in ambient temperature and vibration. Avoid a hazardous (classified) location as defined in Article 500 of the NFPA Handbook of the National Electrical Code.

- Instrument should be placed on a flat, level surface that does NOT exceed more than 1 degree of tilt (left to right and front to back).

**CAUTION: A surface that exceeds this requirement can effect measurement results.**

- Surface should be vibration free.

**CAUTION: Vibration from other machines or devices can effect measurement results.**

## LEVELING INSTRUMENT

A bubble level located on the top surface of the instrument aids in leveling the instrument for optimum test weight measurement.

- Adjust the feet (4) on instrument bottom until bubble is in the center of the level.



## SECURITY

*NOTE: GAC 2500-INTL instruments are shipped in unsecure mode.*

A security switch is located on the outside back panel. The security switch, when enabled, allows limited access to screens in accordance with government requirements. Buttons appear grey for those screens not accessible.

Some top menu buttons, i.e. System, provide access to the menus but certain functions within that menu are not accessible.

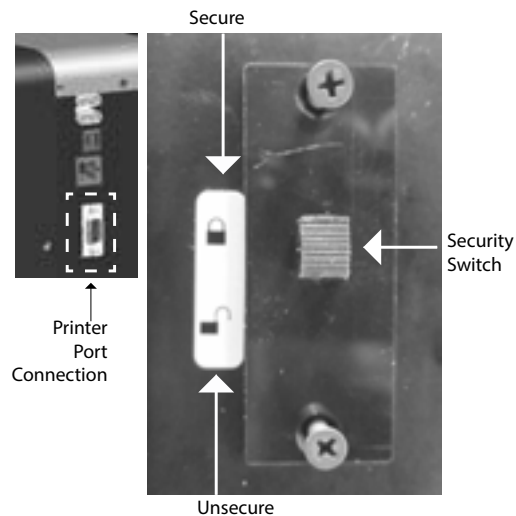
**IMPORTANT: Some INTL machines are also equipped with a seal that covers the security switch. Check with DICKEY-john Technical Support group or your local service center before breaking the seal. When the switch is toggled from secure to unsecure, an event is logged into memory for traceability.**

### To Change Security Switch Position:

The security switch is located below the printer port connection. A protective brace is secured over the switch with (2) screws that must be removed to toggle the switch.

*Figure 11*

*Security Switch Location*



*NOTE: When the switch is toggled from secure to unsecure, an event is logged into memory for traceability.*



1. Use a screwdriver to remove screws holding brace.
2. Remove brace and screws and set aside.
3. Toggle switch to desired secure or unsecure position.
4. Flip brace to the opposite direction and reinstall over the switch.
5. Insert screws to hold brace into position over switch.

The instrument does not require a restart when the security switch is changed.

**IMPORTANT: It is recommended to reattach the brace to avoid unwanted security switch adjustment.**





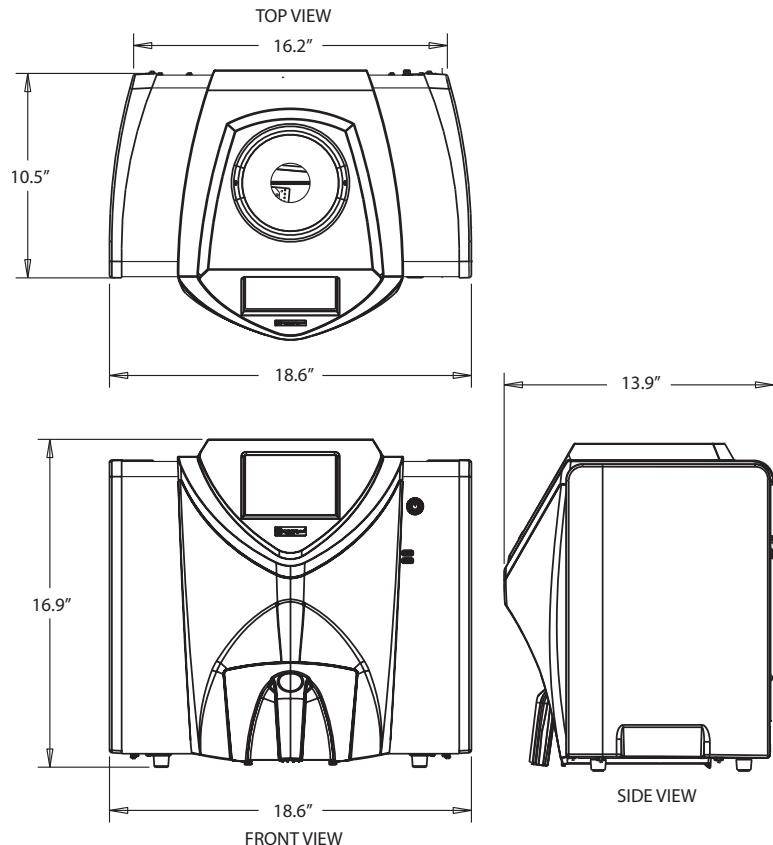
## INSTALLATION

The GAC<sup>®</sup> 2500 unit requires minimal setup. The unit is fully assembled and ready for operation after attaching the AC power cord and inserting the grain drawer.

**NOTE:** After unpacking, visually inspect for damage occurring during transit. Save all packing materials until inspection is complete. If damage is found, file a claim with the carrier immediately and notify your DICKEY-john sales representative.

**Figure 12**

### Unit Dimensions



## CONNECTING AC POWER

**NOTE:** DO NOT REPLACE THE SUPPLIED, DETACHABLE AC POWER CORD WITH A NON-DICKEY-JOHN POWER CORD.

1. Securely connect power cord into the AC plug connection (Figure 2) located on the back of the unit.
2. Plug the male end into an appropriate 3-wire (grounded) outlet.



**The grounding pin on the line cord connects directly to the GAC<sup>®</sup> 2500 frame. When using an adapter ensure the grounding wire is connected properly to a good earth ground to prevent a shock hazard.**



## GRAIN DRAWER

The unit is equipped with a standard grain drawer with handle. An optional bottomless grain drawer is available for purchase from DICKEY-john.

## OPTIONAL BOTTOMLESS GRAIN DRAWER

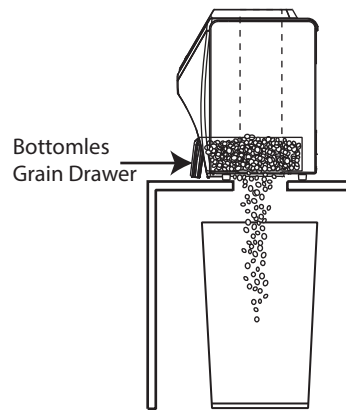
Part Number: DRAWEROPGAC2500

A bottomless grain drawer is used with a flow-through work counter that allows the tested grain samples to fall through to a larger container below. The size of the hole must be at least equal to the drawer dimension and located directly beneath the grain sample drawer.

*NOTE: Contact DICKEY-john Europe at 33 1 41 19 21 81 for additional information on grain drawers.*

*Figure 13*  
*Flow Through Work Counter*

---





## INITIAL SETUP

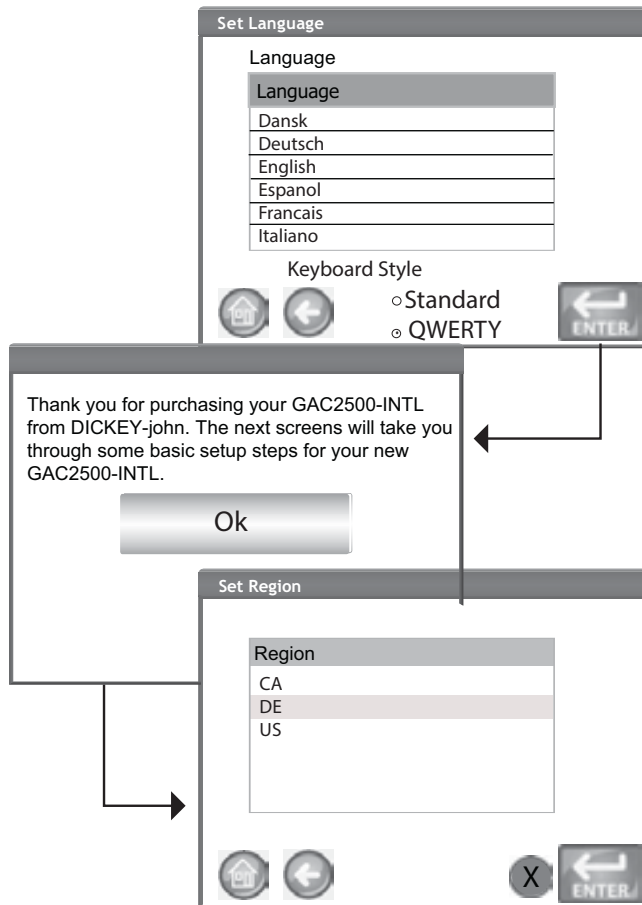
When powered on for the first time, the GAC 2500-INTL instrument will force the selection of the desired region and language. These screens automatically appear.

1. Select the Language by highlighting and press **Enter**.
2. Select the Region by highlighting and press **Enter**.

The instrument proceeds with setup and the desired settings selected.

This step does not occur after initial setup but both screens are available by pressing the **System** button and selecting the Region and/or Language buttons.

*Figure 14*  
*Set Region and Language*





# OPERATOR'S MANUAL

---





## NAVIGATION

The user interacts with the GAC® 2500 via the LCD touch screen display. Screen interaction by finger touch or using a dull, pointed object, such as a stylus or pen is recommended.

Refer to Maintenance section for cleaning display.

### CAUTION

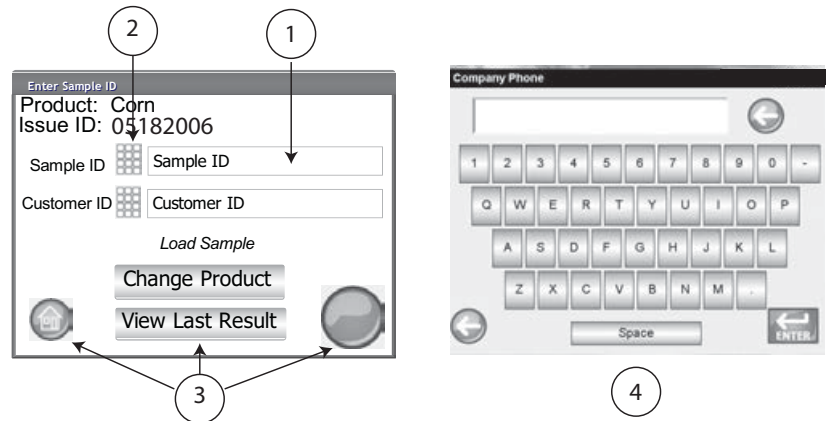
**Do not use any sharp objects on the display. Damage to screen can result.**

The following methods allow navigation through and interface with the unit:

1. Text input boxes
2. Keypad icon (enables keyboard)
3. Buttons
4. Keyboard

Figure 15

LCD Touch Screen Display



## USING EXTERNAL DEVICES

The following external devices can be used to enter data and navigate through the screens by connecting to the USB ports (2 front/2 back):

- keyboard
- mouse
- barcode scanner

## TOUCH SCREEN BUTTON FUNCTIONS

### HOME

**Home** button is available on most screens and, when pressed, returns to the Main Menu screen.





## POWER OFF

**Power Off** button turns the system off from the touch screen display. The system must be turned on using the On/Off button located on the front panel but can be turned off from either the screen display or the On/Off button.



## INITIATE

The **Initiate** button is used to analyze grain and has 3 states of operation:

Green = proceed to begin test

Yellow = an action is required to proceed

Red = system cannot process; error has occurred



## PRINT

**Print** button allows printing test results to a local printer. Refer to the Setup section for print requirements.



## BACK

**Back** button returns to the previous screen.



## ABORT

**Abort** button dumps grain from hopper, empties the cell, and aborts test.



## ENTER

**Enter** button accepts action taken and proceeds to next screen.



## USB

**USB** button is used when connecting the unit direct to a computer for downloading software and installing calibrations.



## USER

**User** button appears on the Main Menu screen only if a User ID has been enabled in System Setup. Requires a tester to enter a User Name before a grain analysis can proceed and will print on a ticket.



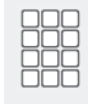
## INSTRUMENT INFORMATION

**Instrument Information** button appears on the Main Menu screen providing details regarding unit service date, serial number, and software version. Typically used for troubleshooting purposes.



## LCD DISPLAY TOUCH SCREEN CALIBRATION

**Display Touch Screen Calibration** button re-calibrates the display when screen responsiveness does not occur effectively to a finger touch or stylus. This button is located at the System Setup Service menu.



## KEYPAD

The **Keypad** icon appears on those screens that require text entry. Pressing the Keypad icon opens the virtual keyboard for typing text in English on the screen. The virtual keyboard is used when an external keyboard, mouse, or bar code scanner are not available.

*Figure 16*  
*Keyboard*



## CLEAN

**Clean** button appears on the Instrument Information screen and allows cleaning the cell and door using an automated process. During the cleaning sequence, the hopper door automatically opens.



## REGION

**Region** button navigates to the Region screen and allows selection of a different region.



## IMPORT REGION

**Import Region** button adds a new region to the instrument via USB memory device at the Region screen.



## DELETE REGION

**Delete Region** button removes a region from the instrument at the Region screen.





## PASSWORD RESTRICTIONS

*NOTE: Some functions are not available when the security switch is set to Secure mode due to governmental regulations and appear in a gray tone.*

Setting an Admin user name and password to restrict system settings to be controlled by an administrator are optional. The unit is shipped with an Admin user name and password setting of "GUEST".

Keeping the Admin user name and password as "GUEST" retains the unit in open access mode allowing any user to enter System Settings and modify unit settings.

**IMPORTANT: To restrict access to System Setup that affects overall unit functionality, a new Admin user name and password must be created.**

### To Create an Admin User Name and Password:

1. At the Main Menu screen, press the **Setup** button.
2. Leave the Admin Username and Password as GUEST and press the **Enter** button.
3. At the Setup screen, press the **Admin Settings** button.
4. At the Enter New Password screen, press the Admin Username keypad icon and enter an administrator user name.
5. Press the **Enter** button to accept.
6. Enter a Password and re-enter password to confirm.
7. Press the **Enter** button to accept.

*NOTE: An external keyboard, bar code scanner, or mouse can be used to enter data into the unit.*

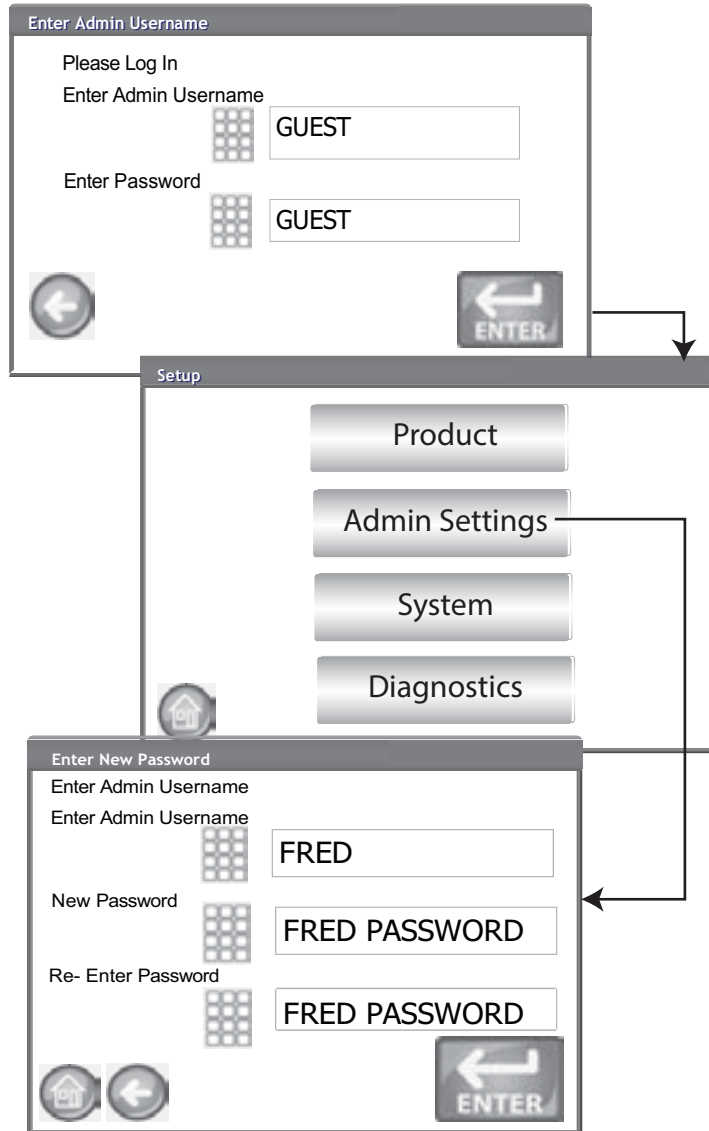
Once a new password is created, the unit is configured so that an administrator name and password is required to gain entry into the System Setup screens. Password and User Name can be any combination of letters and numbers.

Refer to Administrative Settings in the System Settings section to change an Administrator user name and password or reset to open access.

**IMPORTANT: The following words should be not used as User Names: (ROOT, GUEST, REBOOT, RESET).**



Figure 17  
Password Screen





## SETUP

*NOTE: Some functions are not available when the security switch is set to Secure mode due to governmental regulations and appear in a gray tone.*

Setup establishes basic unit operating parameters and allows customization of the user interface by:

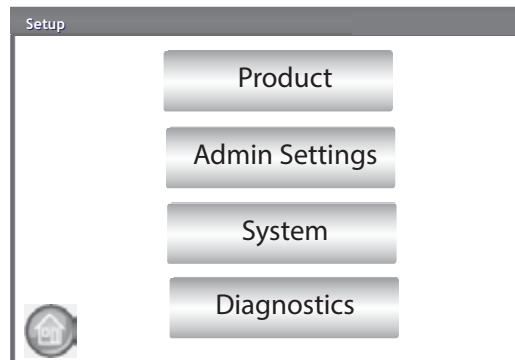
- Editing an existing product and loading new products (Product button)
- Setting administrative levels (Admin Settings button)
- Setting system parameters for external devices, language/locale preferences, time/date, sample result output, unit measurement, sample/customer ID's, delete records, and printing formats (System button)
- Diagnostics for troubleshooting and unit information (Diagnostic button)

### To View Setup Options:

1. At the Main Menu screen, press the **Setup** button.
2. Enter User Name and Password, if required, and press the **Enter** button to display the Setup screen. If defaulted to Name (Guest) and Password (Guest) press the **Enter** button.

*Figure 18*

*Setup Screen*



## PRODUCT

The Product screen is used to:

- Edit existing products
- Load new products

### EDIT EXISTING PRODUCT

If for any reason non-official calibrations need adjustment, certain product parameters can be changed as follows:

- Modifying moisture and test weight bias and moisture and test weight slopes
- Creating a new product by copying a similar product (duplicated and saved using a different name and Issue ID)
- Deleting an existing product from appearing on active screens

*NOTE: Official calibrations are regulated and cannot be altered.*





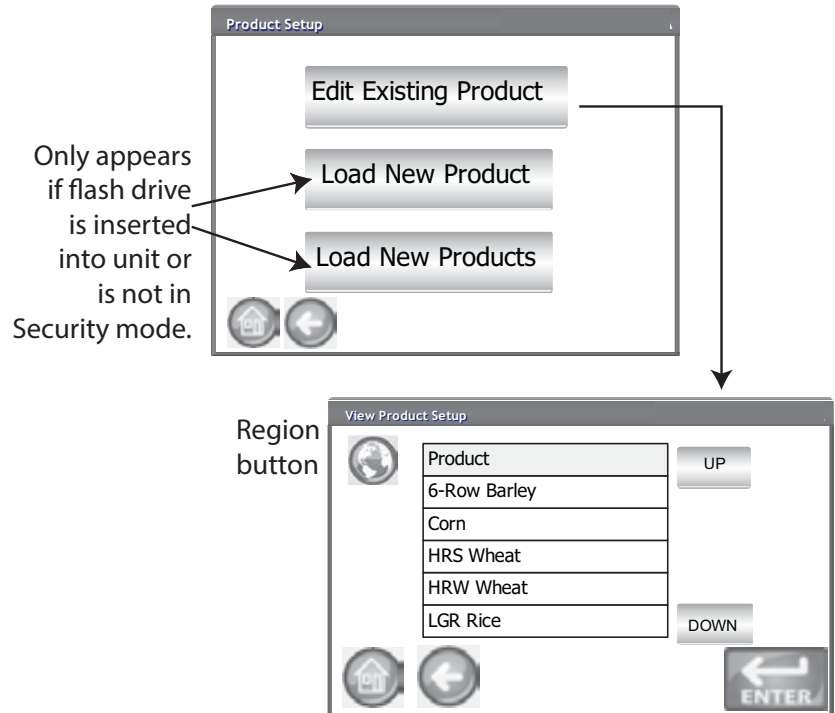
## To Edit an Existing Product:

1. At the Product Setup screen, press the **Edit Existing Product** button.
  - At the View Product Setup screen an alphabetical product list appears. Press the **Up** or **Down** button to display additional products.
  - Press the **Region** button to select a different region.

Figure 19

Edit Existing Product Screens

**NOTE: Calibrations are dictated by the local governing agency and may vary by region.**



2. Press the desired product to highlight and press the **Enter** button to select. Once the product is selected, the product's parameters display in a table.
3. Select the desired action:
  - Edit product (does not display on screen for official calibrations)
  - Create product
  - Delete product



## EDIT PRODUCT

A product's moisture bias, test weight bias, moisture slope, and test weight slope can be changed at this screen. All official calibrations are locked and cannot be modified. A product's calibrations should only be changed by an authorized user.

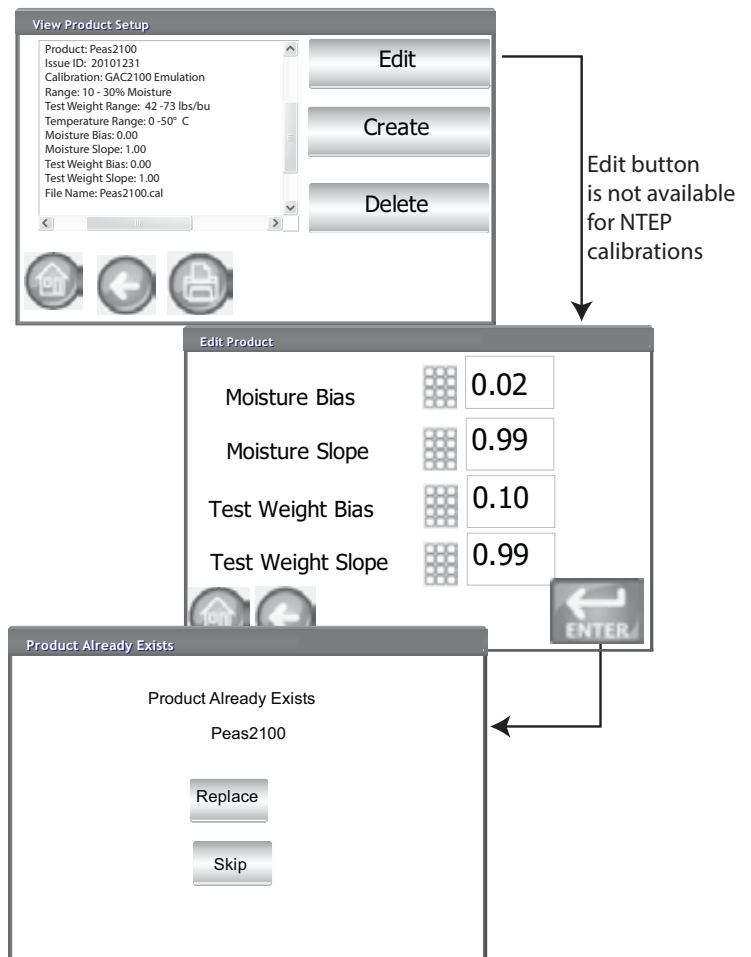
*NOTE: A product's detail at the View Product Setup screen can be printed by pressing the **Print** button.*

### To Edit a Product:

1. At the View Product Setup screen, press the **Edit** button.
2. At the Edit Product screen, press the keypad icon to modify a product's parameters.
3. When finished, press the **Enter** button.
4. Confirm product replacement by pressing the **Replace** button at the Product Already Exists screen. The **Skip** button returns to the previous product's bias and slope setting.
5. The new bias and slope appears in the product table on the View Product Setup screen. The product name and Issue ID will remain the same.

*NOTE: An external keyboard, bar code scanner, or mouse can be used to enter data into the unit.*

*Figure 20*  
*Edit Product*





## CREATE PRODUCT

A new product can be created by copying a similar product's parameters. Creating a new product name and Issue ID prevents an existing product's parameters from being overwritten.

*NOTE: An external keyboard, bar code scanner, or mouse can be used to enter data into the unit.*

### To Create a Product:

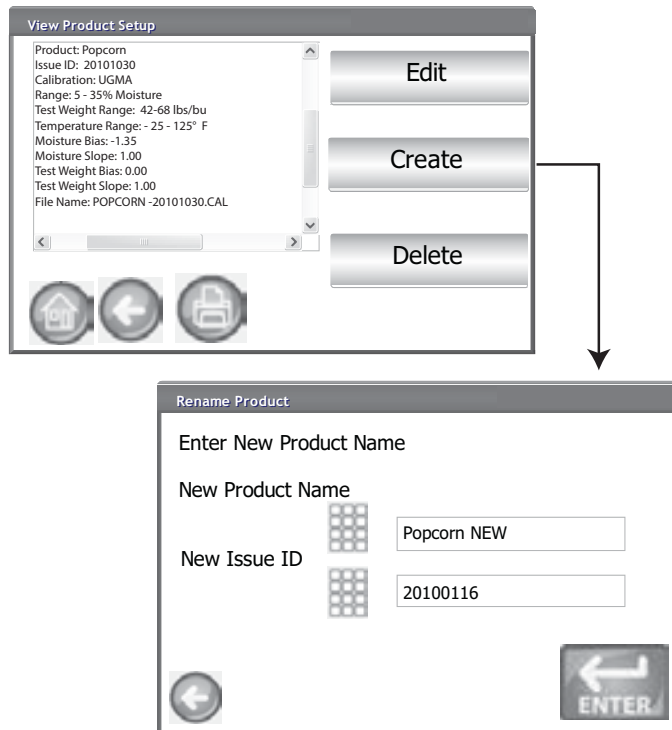
1. At the View Product Setup screen, press the **Create** button.
2. At the Rename Product screen, the product name and NEW appears as the default name.
3. Press the keypad icon to enter a different product name, if desired.
4. A new Issue ID is automatically defined for the new product. Press the keypad icon to enter a different Issue ID, if desired.
5. Press the **Enter** button to save.

**IMPORTANT: Non alphanumeric keys cannot be used to create an Issue ID, Product Name, or Sample ID (examples include: &, \*, /, #).**

*NOTE: Some functions are not available when the security switch is set to Secure mode due to governmental regulations and appear in a gray tone.*

*Figure 21*

*Creating a Product Screen*





## DELETE PRODUCT

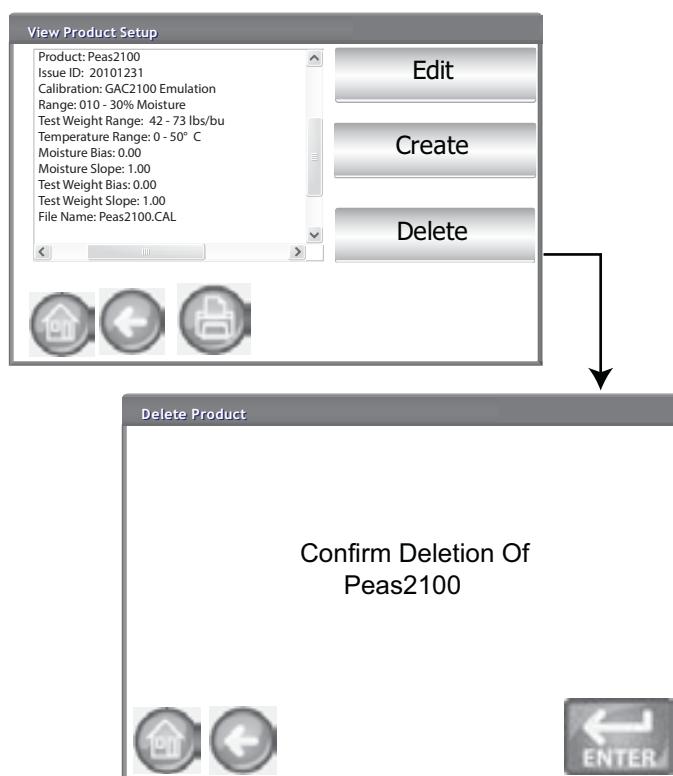
A product and its calibrations can be deleted so that it does not appear on the active user screens. A product and its history is stored in the unit's database and can still be viewed on the Audit Trail screen after it has been deleted.

### Deleting a Product:

1. At the View Product Setup screen, press the **Delete** button.
2. At the Delete Product screen, press the **Enter** button to confirm deletion.

*Figure 22*

*Delete Product Screen*





## LOAD NEW PRODUCT

New product calibrations can be loaded to the GAC® 2500 via a USB memory device. The **Load New Product** buttons only appear when a USB memory device is inserted in the unit.

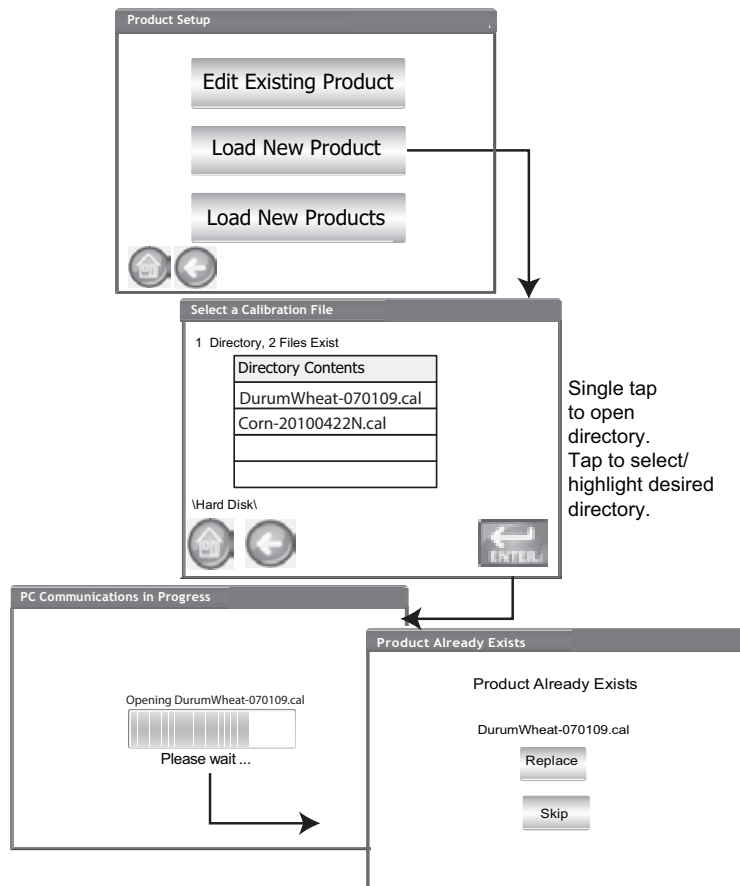
*NOTE: Some functions are not available when the security switch is set to Secure mode due to governmental regulations and appear in a gray tone.*

### Loading a Single Product:

1. Insert the USB memory device to the unit's USB port on front panel of unit.
2. At the Product Setup screen, press the **Load New Product** button.
3. Navigate to the directory where the product is located, press on the product name to highlight, and press **Enter** to begin download. A progress bar indicates downloading status.
  - A single tap is required to select the desired file.
  - Pressing “..” located at the top of the list returns to previous level in the directory structure.
4. If a product calibration already exists on the instrument, accept the new calibration by pressing the **Replace** button or the **Skip** button to revert to the existing product.

*NOTE: Contact a DICKEY-john representative for assistance with obtaining updated calibrations or with transferring data to the unit.*

*Figure 23  
Load New Product Screen*





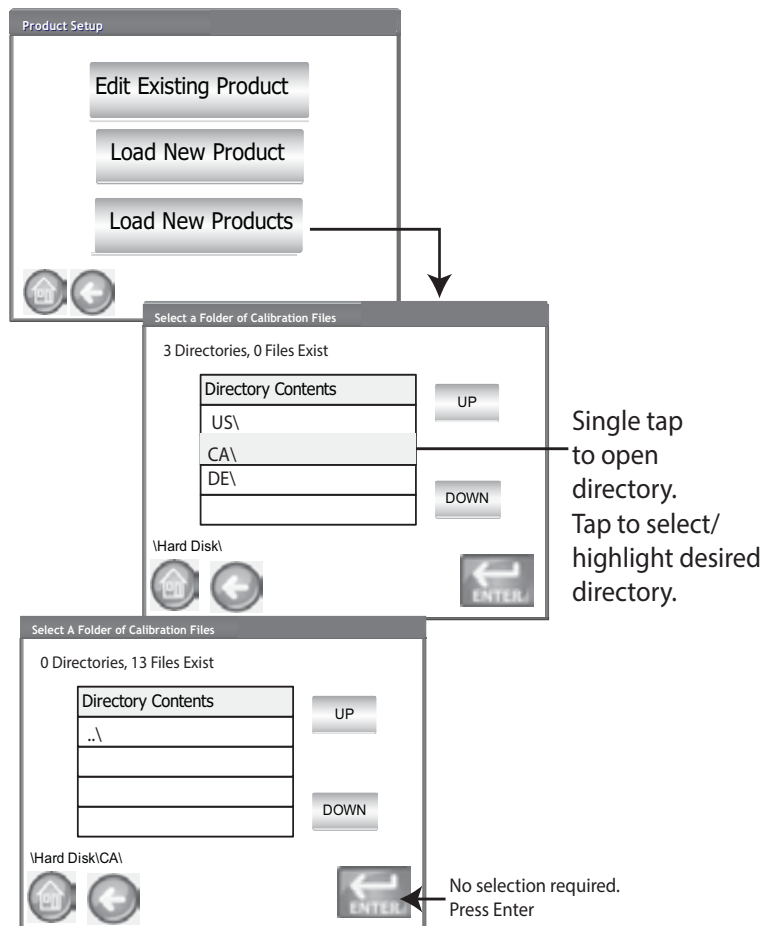
*NOTE: Product calibrations are available for download at DICKEY-john's website. [www.dickey-john.com/products/Agriculture/Moisture Testing/INTERNATIONAL/GAC2500-INTL/Get Support/Downloads](http://www.dickey-john.com/products/Agriculture/Moisture%20Testing/INTERNATIONAL/GAC2500-INTL/Get%20Support/Downloads).*

## Loading Multiple Products:

1. Insert the USB memory device to the unit's USB port on front panel of unit.
2. At the Product Setup screen, press the **Load New Products** button to load all products from the selected directory of the memory device or PC.
3. When loading multiple products, navigate through the directory structure and highlight the directory containing the desired products to load. A progress bar indicates downloading status.
  - A single tap selects the desired directory.
  - Pressing "..\" located at the top of the list returns to the previous level in the directory structure.
4. Press the **Enter** button to begin download.
5. If product calibrations already exist on the instrument, accept new calibrations by pressing the **Replace** button or the **Skip** button to revert to the existing product.

*NOTE: You must know the directory where the files are saved as names do not display.*

**Figure 24**  
*Load Multiple Products Screens*





## ADMINISTRATIVE SETTINGS

If the instrument is set with an administrator password, the password can be changed to a different admin user name and/or password.

*NOTE: Refer to the Setting Password Restrictions section for creating a user name and password.*

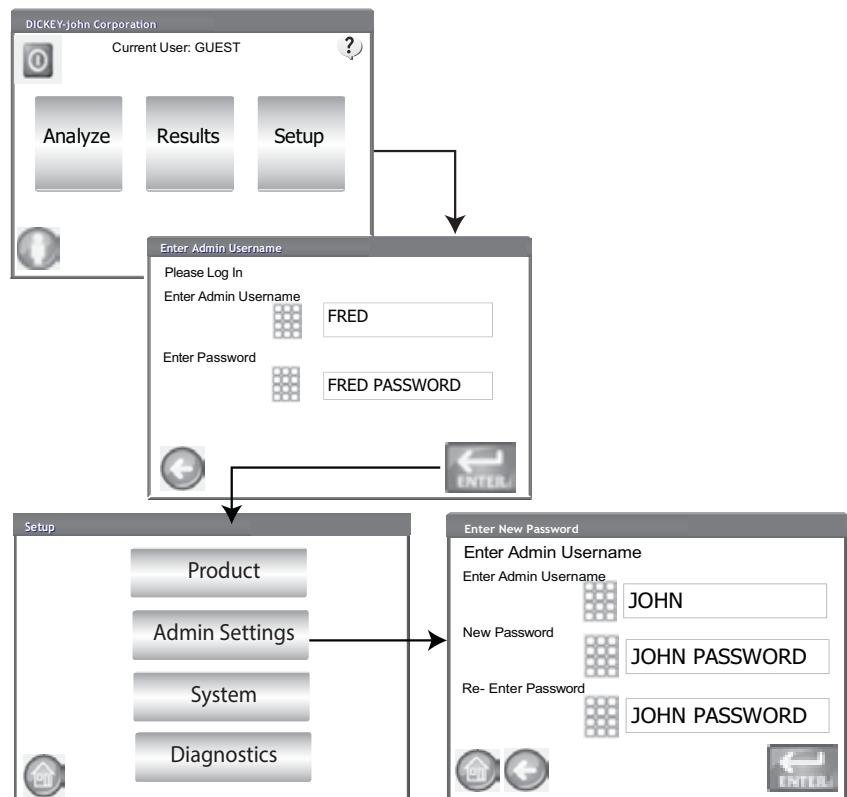
### TO CHANGE A KNOWN USER NAME/PASSWORD

1. At the Main Menu screen, press the **Setup** button.
2. At the Password Login screen, enter existing user name and password.
3. Press the **Enter** button to accept.
4. At the Setup screen, press the **Admin Settings** button.
5. Press the **Admin Settings** button to display the Admin Settings screen.
6. Press the keypad icon and enter a new Admin Username.
7. Enter New Password and re-enter password for verification.
8. Press the **Enter** button to accept changes.

The new user name and password is saved when the **Enter** button is pressed.

*Figure 25*

### *Reset User Name and Password*



Contact DICKEY-john Tech Support or a local representative to reset instrument to open access mode.



## SYSTEM SETUP

System Setup allows customization of the unit's functionality and print settings:

*NOTE: Some functions are not available when the security switch is set to Secure mode due to governmental regulations and appear in a gray tone.*

- Printer/scale setup
- Language selection
- Region selection
- Time and date setup
- Test result setup (automatic, manual return)
- Exporting data format (CSV, Excel)
- Units of measurement
- Sample setup (sample, user ID)
- Owner data (troubleshooting information)
- Service information (technician information)
- Clear database
- Check scale
- Network setup (technician recommended)
- Update instrument (technician recommended)

## PRINTER SETUP

A USB or RS232 serial port connection is available to connect a printer that prints test data results to a ticket. Streaming data serially is an option when using the USB printing function.

The ticket can be customized to include details as it relates to facility, date, time, testing errors, and product results. The unit can be set to automatically or manually print a ticket at the end of each test.

*NOTE: Reference the printer's specifications for correct settings.*

### To Set Printer Settings:

1. At the System Setup screen, press the **Printer** button.
2. At the Printer Setup screen, enable the check box for the type of connection between the unit and printer:
  - RS232 connection using a Null modem cable
  - PCL USB when connecting to a PCL USB printer
  - Star USB when connecting to an SP712 USB printer
3. For an RS232 connection, select the Baud Rate, Byte Size, Parity, and Stop Bits that match the printer.
4. When sending results to a printer, a Header and Footer can be added to print on each ticket, if desired. Refer to Adding a Header/Footer section.
5. Press the **Test** button to verify that the printer and/or computer and the unit's print settings match for proper communication between the devices.
6. When enabled, **Automatically Print Upon Sample Result** will print a ticket at the end of each test.
7. When enabled, **Include Line Feeds After Print** allows additional line feeds to be added at the end of each ticket after printing.
8. Streaming data serially sends data serially when USB is selected. Refer to the Streaming Data Serially selection.

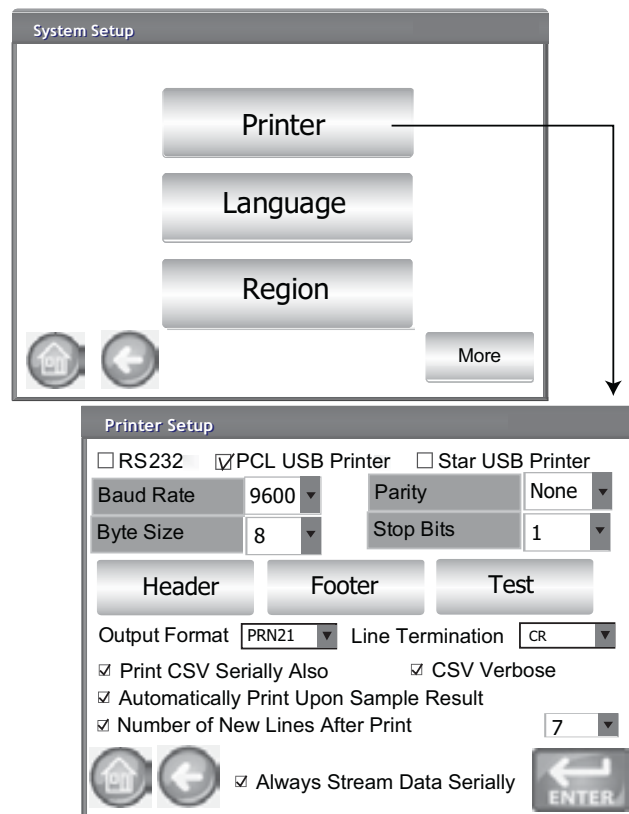




**NOTE:** When printing to a database using an RS232 connection and CSV printer output format, a line feed of 1 is required for a carriage return/line feed.

9. Select the output format.
  - PRN20 - Standard 20 column printer output
  - PRN21 - Special 20 column printer output
  - PRN80 - Standard 80 column printer output (80 characters per line)
  - PRN81 - Standard 80 column printer output (81 characters per line)
  - PTB - A custom region-based format to meet governing body formats
  - CSV01 - Comma separated variables (requires a 9600 baud rate) selected when test results are sent to a computer.
  - NTEP- A custom format for federal agencies
  - AUTO - A custom format for federal agencies.
10. Select the line termination style.
  - CR - Carriage return
  - CRLF - Carriage return, line feed
  - LF - Line feed
  - LFCR - Line feed, carriage return

*Figure 26*  
*Selecting a Printer Type*





*NOTE: An external keyboard, bar code scanner, or mouse can be used to enter header and footer information.*

## ADDING A HEADER AND FOOTER TO TICKET

Header and Footer text can be added to print on a print ticket. Owner Data text can be selected as the default or customized text can be entered.

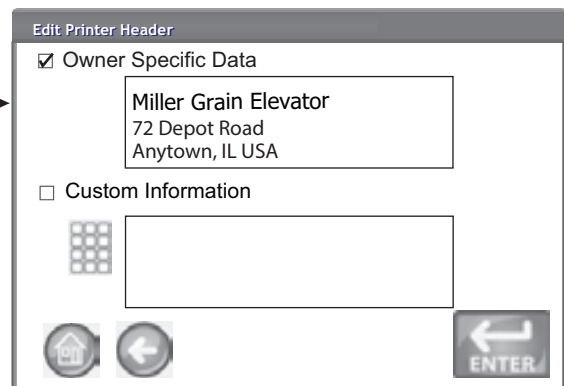
### To Enter a Header/Footer:

1. At the Printer Setup screen, press the **Header** button.
2. To use the Owner Data address information, enable the check box next to the company name and address. If the owner data text box is blank, owner data information has not been entered at the Owner Data screen and can be entered at the System Setup screen, **Owner Data** button.
3. To enter other text, deselect the Owner Data check box.
4. Press the keypad icon on the screen of the lower text box to open the unit's keyboard and enter desired text.
5. Press the **Enter** button to accept.
6. If desired, enter a footer name by pressing the **Footer** button. Enter desired information to appear in footer.

*Figure 27*

*Header Screen*

Entered at  
Owner Data →  
screen



## STREAMING DATA SERIALLY

Streaming data is available in two methods:

### Print CSV Serially Also

When only this feature is enabled, CSV data is transmitted out of the serial port when the **Print** button is pressed along with a print receipt.

### Always Stream Data Serially

When the above "Print CSV Serially Also" is enabled, the optional feature "Always Stream Data Serially" appears onscreen. With this option enabled, data is always transmitted serially out the serial port to an external system whether the Print button is pressed or not.

Both printing and streaming data can be enabled to perform both functions simultaneously or act independently, if desired.

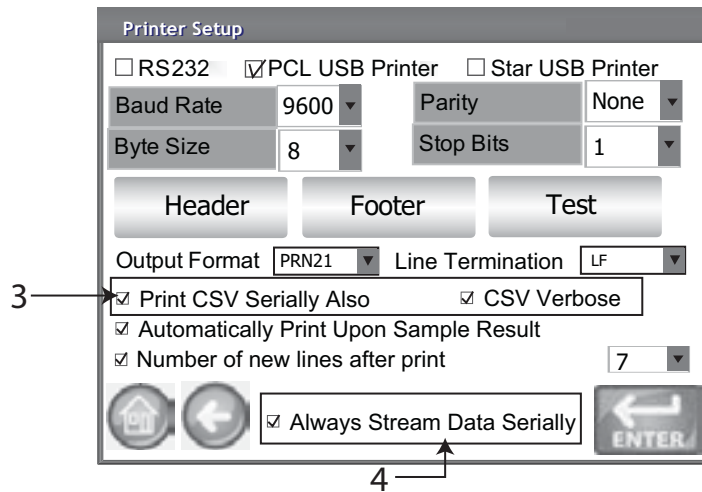


## Enable Data Streaming:

1. At the System Setup screen, press the **Printer** button.
2. Select either USB Printer option.
3. To print to a strip printer and CSV serially, select the “Print CSV Serially Also”.
4. To always stream data serially after each test, select the “Always Stream Data Serially” option.

Figure 28

Enable Data Streaming



## PRINTER/SCALE SETUP

The GAC 2500 can be set to print test data results to a ticket via a printer as well as interface with a scale. To interface with a printer and scale certain parameters must be selected on the Printer Setup screen:

1. At the System Setup screen, press the **Printer** button.
2. Baud Rate must be set at 9600 to communicate with a scale. At the Printer Setup screen verify the Baud Rate of 9600 is selected.
  - The RS232 checkbox must be selected to view the Baud Rate.
3. To interface with a printer and scale, check either the PCL or Star USB checkbox.
  - When the USB box is checked, the unit can output to both the USB and RS232 port. The USB port communicates with the printer and can operate with any printer output format (step 5).

**IMPORTANT: When the output desired is to a scale and a printer via USB, Print CSV Serially Also and a Baud Rate of 9600 must be selected.**

4. To interface with a scale only, check the RS232 box.



5. Select the output format for the printer.
  - PRN20 - Standard 20 column printer output
  - PRN21 - Special 20 column printer output
  - PRN80 - Standard 80 column printer output (80 characters per line)
  - PRN81 - Standard 80 column printer output (81 characters per line)
  - CSV01 - Comma separated variables (requires a 9600 baud rate) selected when test results are sent to a computer.
6. Select the line termination style.
  - CR - carriage return
  - CRLF - carriage return, line feed
  - LF - line feed
  - LFCR - line feed, carriage return
7. When enabled, **Automatically Print Upon Sample Result** will automatically print a ticket at the end of each test. When disabled, a ticket must be manually printed at the end of each test.
8. When enabled, **Include Line Feeds After Print** allows additional line feeds to be added at the end of each ticket after printing.
9. Press the **Enter** button to accept changes.

*NOTE: When printing to a database or scale using an RS232 connection and CSV printer output format, a line feed of 1 is required for a carriage return/line feed.*

## LANGUAGE AND KEYBOARD SETTINGS

The GAC 2500-INTL is equipped with 22 languages that displays the user screens in the language selected.

*NOTE: Languages are continually added to this list. Contact a local DICKEY-john representative for a complete list.*

- Brazilian Portuguese
- Chinese
- Croatian
- Czech
- Danish
- Dutch
- English
- Estonian
- French
- German
- Hungarian
- Italian
- Latvian
- Lithuanian
- Polish
- Portuguese
- Romanian
- Russian
- Serbian
- Slovak
- Spanish
- Swedish

## VIRTUAL KEYBOARD

A **keypad** icon appears on those screens that require text entry. Pressing the Keypad icon opens the virtual keyboard for typing text on the screen. Two keyboard styles are available:



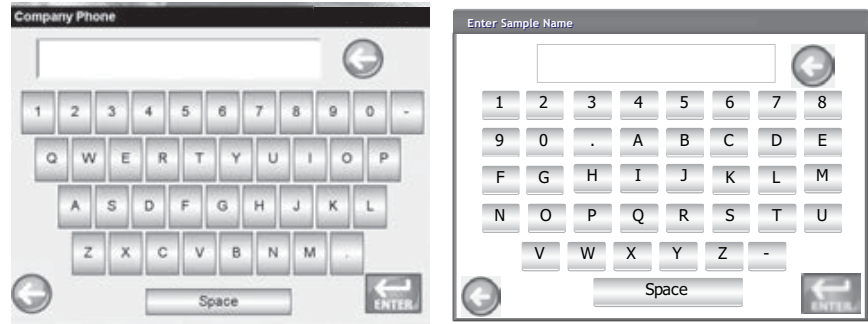


- Qwerty (default)
- Standard

**IMPORTANT: Any text entered using the keyboard appears in English only.**

Figure 29

### Qwerty and Standard Keyboard Styles

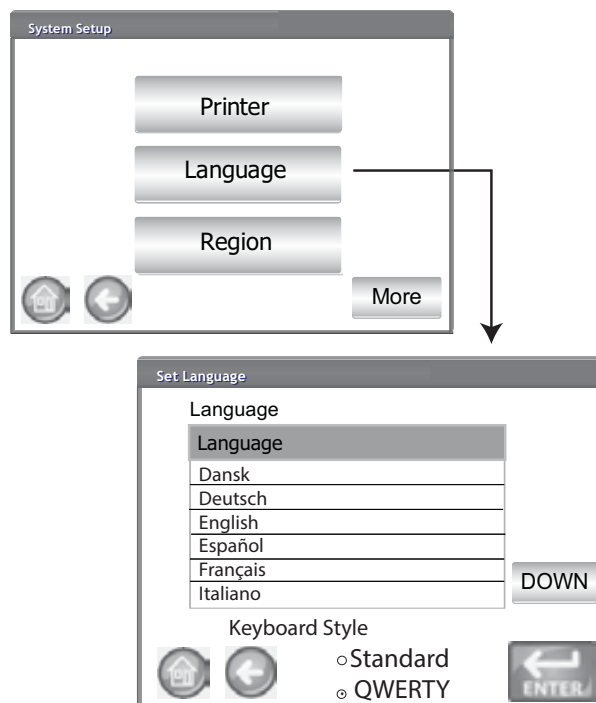


### To Select a Language or Keyboard Type:

1. At the System Setup screen, press the **Language** button.
2. At the Language screen, press the desired language and press **Enter**.
3. To select a keyboard type, press the radio button to enable either QWERTY or Standard style.
4. Unit automatically converts to the selected system language and/or the selected keyboard.

Figure 30

### Language Screen





*NOTE: Some functions are not available when the security switch is set to Secure mode due to governmental regulations and appear in a gray tone.*

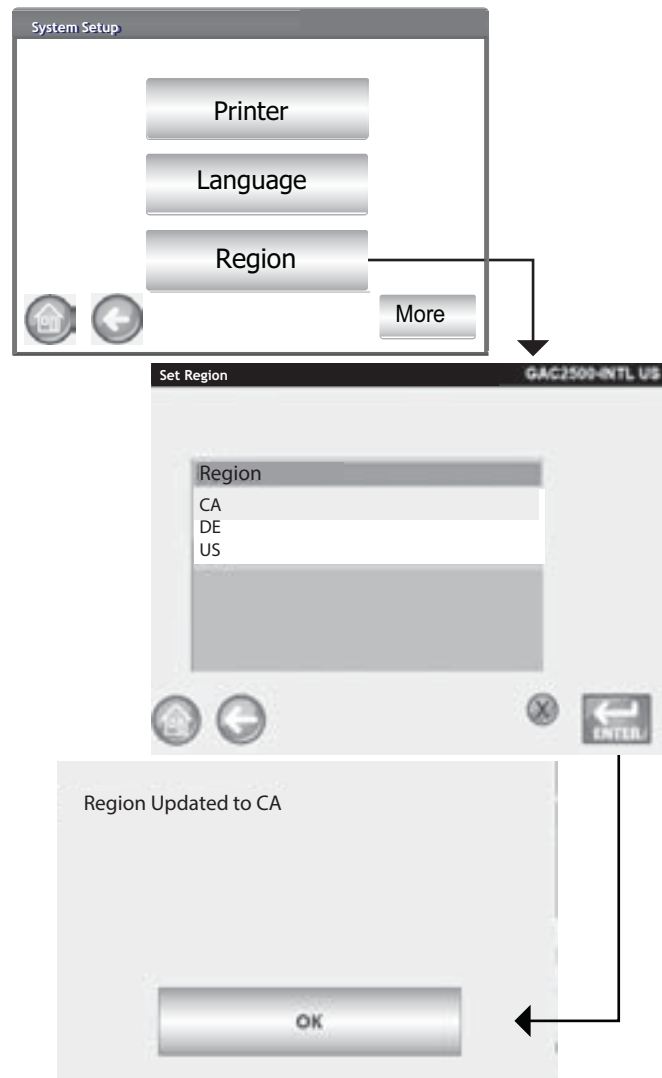
## REGION

The Region screen displays the list of available regions. Import new regions to the instrument via a USB memory device. An instrument's current region setting can be found at the Instrument Information screen and the Region screen.

### To Select a Region:

1. At the System Setup screen, press the **Region** button.
2. A list of installed regions appear on the Set Region screen. Highlight the desired region and press the **Enter** button.
  - A region with an '\*' indicates no calibrations exist for that region.
3. 'X' button deletes the highlighted region calibrations and .ini files. Only press this button to remove the region files from the instrument.

*Figure 31*  
*Setting Region*

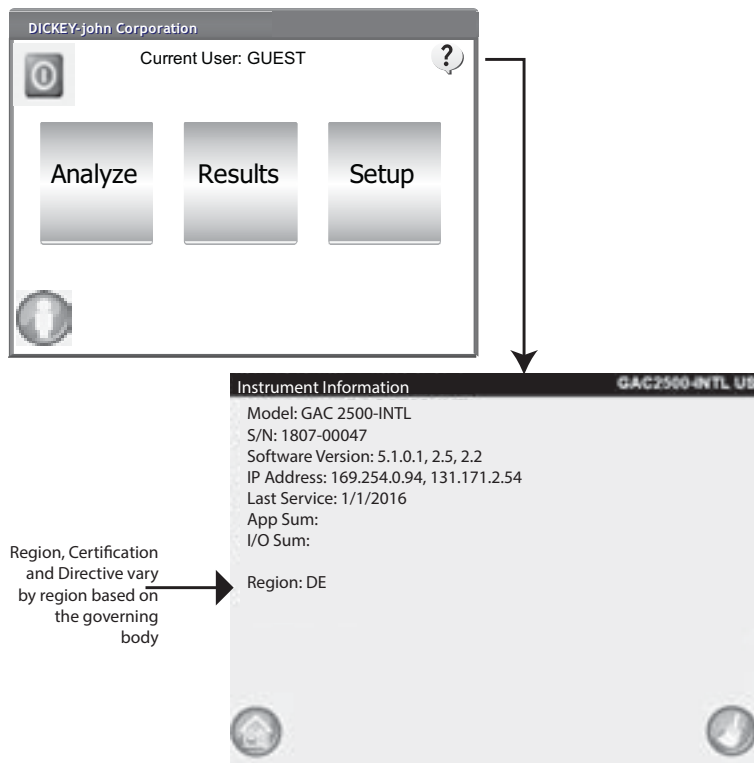




4. Press the **Ok** button to acknowledge region change. The active region is also noted on the Instrument Information screen.

Figure 32

Instrument Information Screen





## IMPORT A REGION

Regions and corresponding calibrations can be imported to the instrument via a USB memory device at 2 different screens: Set Region and Products.

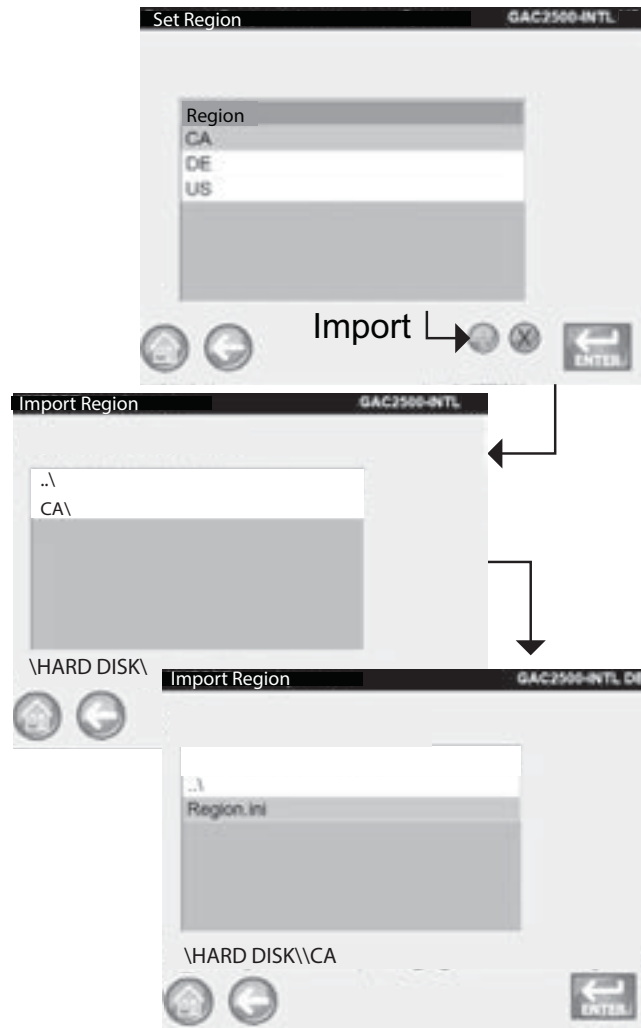
*NOTE: Empty regions with no calibration files are marked with an '\*'.*

### To Import a Region at the Set Region Screen:

1. Insert USB memory device with stored region.ini file and calibrations.
2. At the System Setup menu, press the **Region** button.
3. At the Set Region screen, select the desired region and press the '+' **Import** button. The **Import** button is visible only when a USB memory device is inserted.
4. Select to highlight the Region.ini file and press the **Enter** button.
5. Calibrations will download to the instrument. Upon completion the new Region will appear on the Region screen as a selectable item.

*NOTE: Some functions are not available when the security switch is set to Secure mode due to governmental regulations and appear in a gray tone.*

*Figure 33*  
*Import a Region*





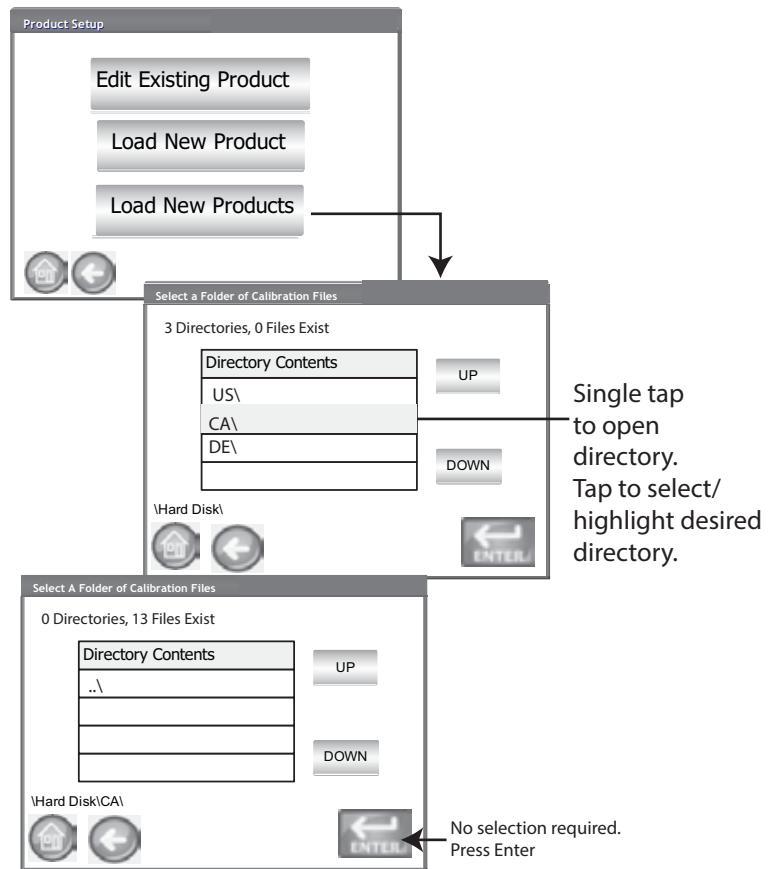


## IMPORT REGIONS AT PRODUCT SCREEN

1. Insert a USB memory device with stored region.ini file and calibrations.
2. At the Setup screen, press the **Product** button.
3. Press the **Load New Products** button.
4. Select the desired region found in the Directory Contents window and press **Enter** button.
5. Press the **Enter** button again to begin download.

Figure 34

Import Regions at Product Screen



## DELETE A REGION

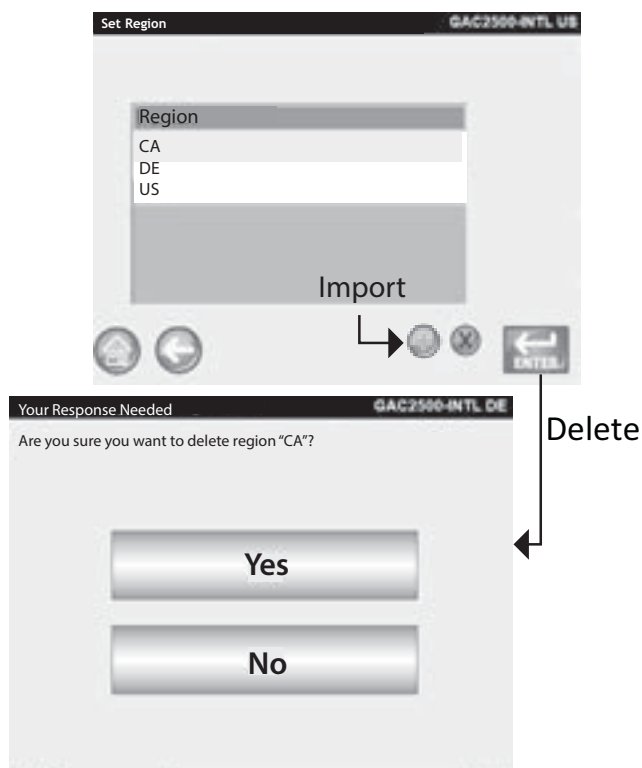
Deleting a region from the instrument removes the region file and all associated calibration files.

### To Delete a Region:

1. At the System Setup screen, press the **Region** button.
2. At the Set Region screen, highlight the Region to delete.
3. Press the **'X'** delete button.
4. Press **Yes** to remove files or **No** to abort.



*Figure 35*  
*Delete A Region*

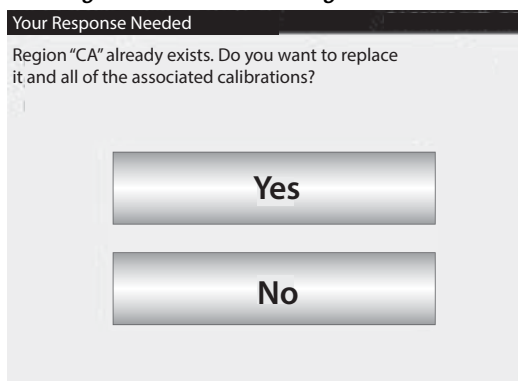


## IMPORTING EXISTING CALIBRATION/REGION FILES

A warning screen displays if trying to import a region and its calibrations that currently reside on the instrument.

- Select NO to abort import
- Select YES to override existing files

*Figure 36*  
*Importing Existing Calibrations and Region Files*





*NOTE: Some functions are not available when the security switch is set to Secure mode due to governmental regulations and appear in a gray tone.*

## SAMPLE SETUP

A Sample ID, Customer ID, User Name (Login) can be enabled so that a grain sample is identified and saved with this information each time a test is performed.

1. At the System Setup screen, press the the **More** button until the **Sample Setup** button appears.
2. Enable the check box of desired ID's required when running samples.
3. Press the **Enter** button to accept.

### Prompt for Sample ID

The Sample ID screen step can be hidden so that the screen does not appear during analysis. If a sample or customer ID is required, "Prompt for Sample ID", should be checked.

Prompt for Sample ID can be enabled even when a sample or customer ID is not required so the screen appears during analysis giving the option to include either of these ID's.

- Enable when a sample or customer ID are required entries before analysis. A sample ID will be associated with each grain test and prints to ticket.
- Disable to eliminate the Sample ID screen before each analysis

### Automatic Sequence Sample ID

Automatic number sequencing to the next higher number will occur with additional tests of the same grain. Sequence Sample ID default is enabled. Reset counter at System Setup/Service Data button.

### User Login Required (Sample ID)

Format for federal agencies.

### Customer ID Required

Requires a Customer ID to be associated with each grain test and prints to ticket. Customer ID default is disabled.

### User Login Required

A User Login requires a tester to login with a user name at the Main Menu screen before grain can be analyzed. If a user login is required, the user name entered at the User Login screen is recorded in the unit's database and prints on the print ticket. The **User** button only appears on the Main Menu screen when enabled. User Login default is disabled.





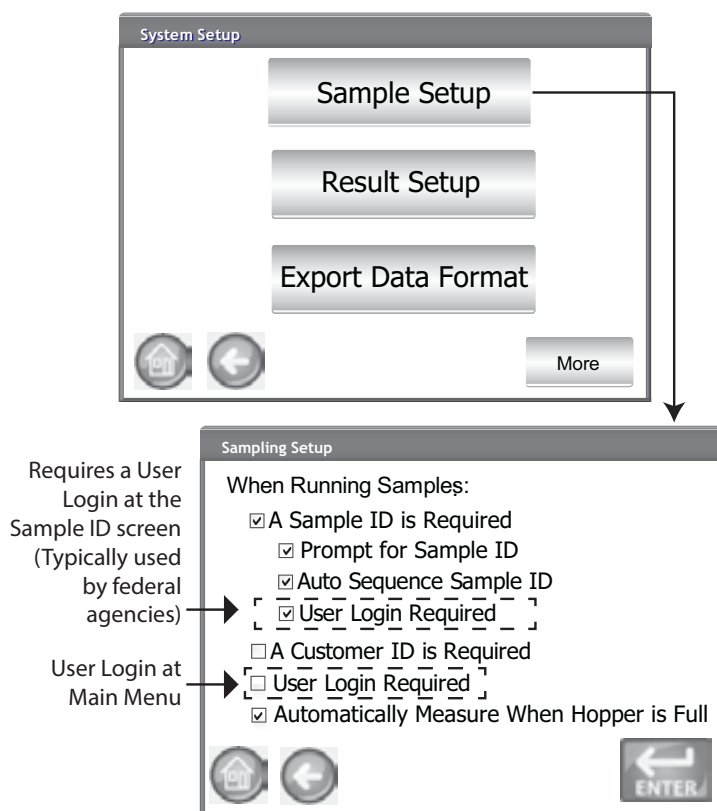
## Automatic Measure When Hopper is Full

Instrument automatically proceeds to measure a sample when the hopper is full eliminating the need to press the **Initiate** button (green).

- Enable this feature to automate the measuring process. If a Sample ID or Customer ID is required, analysis automatically starts at the Sample ID screen. After the ID requirement is met, the measurement automatically starts.
- Disable this feature to require a manual response at each analysis screen.

Figure 37

Sample Setup Screen





**NOTE:** *Some functions are not available when the security switch is set to Secure mode due to governmental regulations and appear in a gray tone.*



## RESULT SETUP

After performing a grain analysis, the unit can be set to automatically advance back to the Sample ID screen from the Analysis Results screen or manually return to this screen with a button press. The unit default is set to manual return. Grain automatically dumps from the hopper in manual or automatic advance mode.

### To Display the Sample Return Setup screen:

1. At the System Setup screen, press the **More** button to display and press the **Result Setup** button.
2. Select the desired feature to enable.
3. Press the **Enter** button to save.

### Automatic Return

Advances from the Analysis screen to the Sample ID screen within a specified period of time (4 to 20 seconds) without pressing the **Initiate** button.

### Manual Return

Advances to the Sample ID screen to perform another test by pressing the **Enter** button after each test.

### Empty Drawer Requirement

A forced empty of the drawer requires a sample dump before proceeding to the next analysis.

### Bottomless Drawer in Use

Must be enabled when the bottomless drawer style is used with a flow-through counter to prevent an empty drawer caution from occurring when running tests.

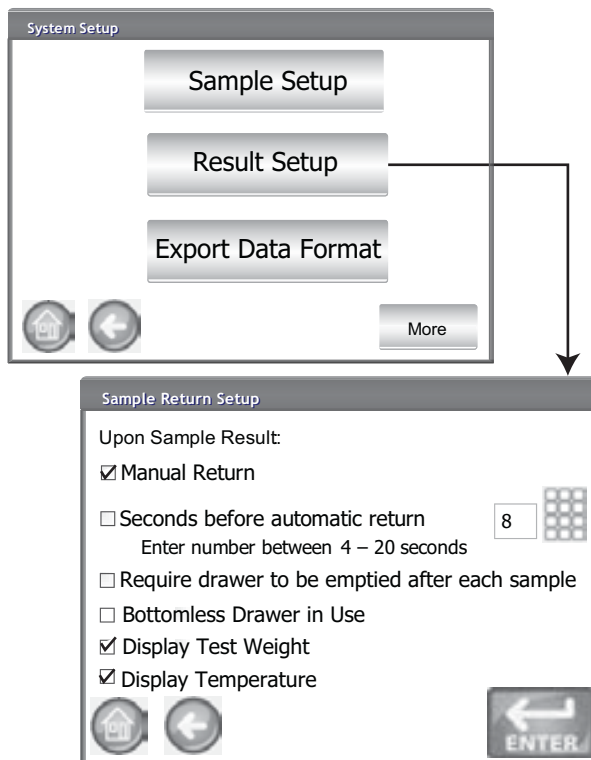
- Grain can also be tested without the grain drawer secured in the unit when Bottomless Drawer in Use is enabled; however, a Drawer Ignored screen appears each time a test is performed and will only proceed to perform test when the **Initiate** button is pressed.

### Display Test Weight and Temperature

Displays the test weight and temperature on the Results screen for each test. Both features are defaulted to enabled.



Figure 38  
Result Setup Screen





## EXPORT DATA FORMAT

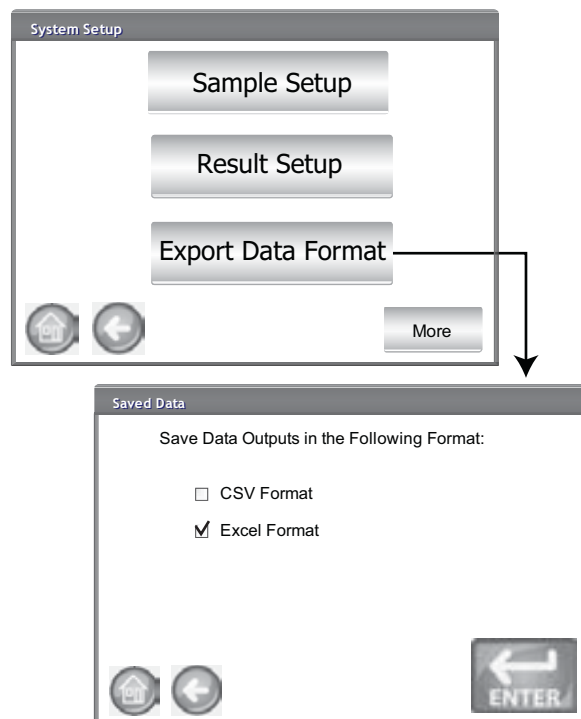
Data can be saved for output to a computer in an Excel or CSV format. The unit default is Excel.

1. At the System Setup screen, press the the **More** button until the **Export Data Format** button appears.
2. Enable the check box of the desired output.
3. Press the **Enter** button to accept.

**IMPORTANT: A USB memory device less than or equal to 2-4 GB in size formatted as FAT is recommended for extracting data from instrument.**

*Figure 39*

*Data Format Screen*





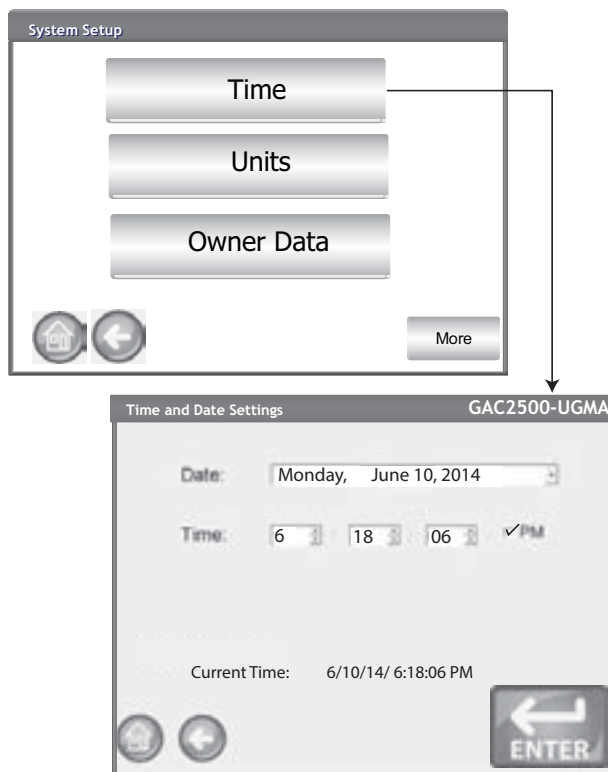
## TIME

*NOTE: Some functions are not available when the security switch is set to Secure mode due to governmental regulations and appear in a gray tone.*

*NOTE: The date can be changed to US or UK format at the Units screen.*

1. At the System Setup screen, press the **Time** button.
2. To select a date, press the Date drop down arrow to display calendar.
3. Use arrows to change the month.
4. Enter time using the up/down arrows.
5. Select PM check box, if applicable.
6. Press the **Enter** button when done.

*Figure 40  
Time and Date Screen*







## UNITS

The Units screen allows selection of:

- Date format (US or Euro)
- Temperature (degrees F or C)
- Unit measurement for test weight (lb/bu or kg/hl)
- Radix point ( , or .)
- Moisture, test weight, and temperature display resolution (tenths or hundredths)

Test Weight defaults to display on the Analysis Results screen but can be removed by disabling at the Sample Setup screen.

*NOTE: Instruments with a Region set to Canada use a Test Weight reference point based on the Avery bushel. U.S. instruments use a Test Weight reference point based on the Winchester bushel.*

### Unit defaults:

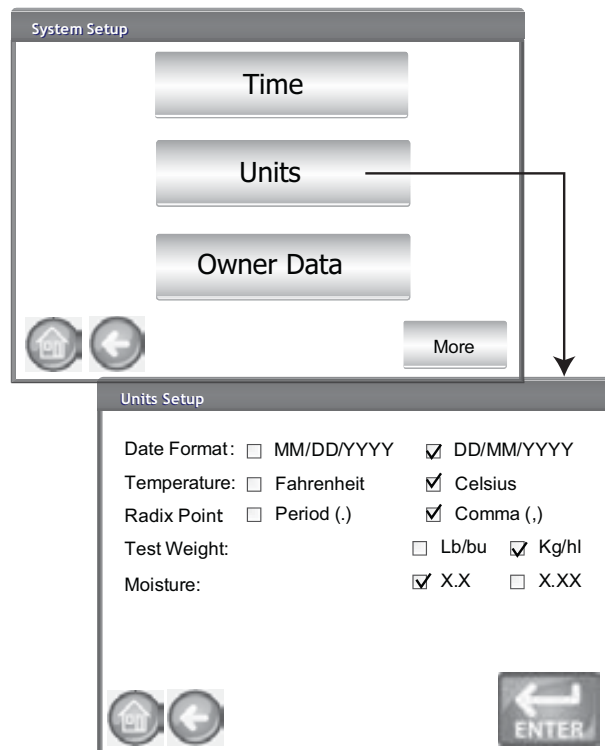
Unit defaults are automatically selected based on the instrument's active region and will adjust accordingly any time that region is changed.

### To Change Units:

1. At the System Setup screen, press the the **More** button until the **Units** button appears.
2. Press the **Units** button to display the Units Setup screen.
3. Enable the respective check boxes.
4. When selected, press the **Enter** button to accept.

Figure 41

Units Screen





## OWNER DATA

Enter name, address, and phone information, if desired. Data entered at this screen can be used as the header/footer on a print ticket.

This data can also be viewed by pressing the **Instrument Information** button found on the Main Menu screen, refer to Printer Setup.

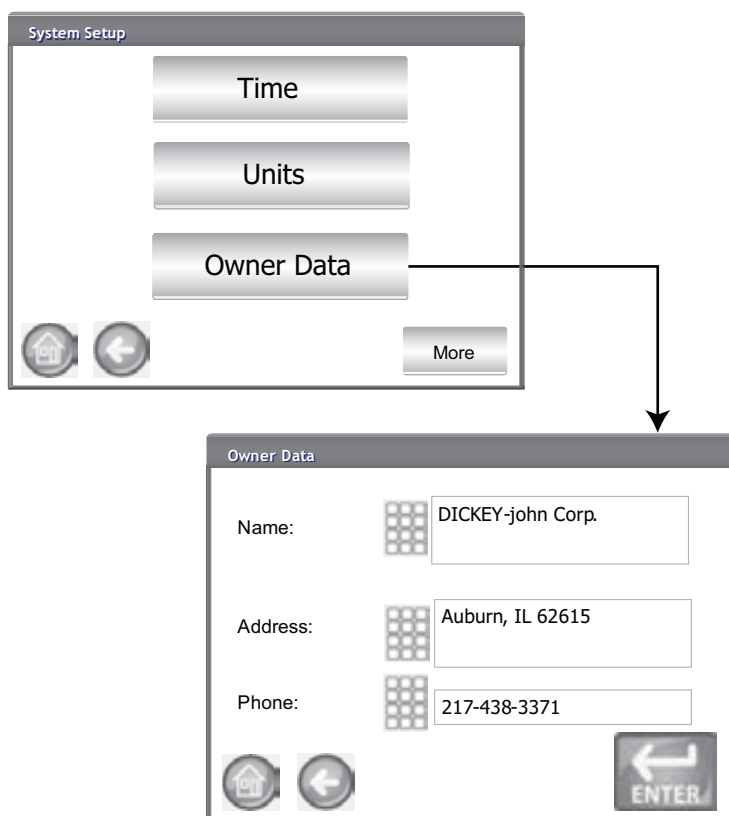


1. At the System Setup screen, press the **More** button until the **Owner Data** button appears.
2. Press the **Owner Data** button and enter name, address, phone number by pressing the keypad icon.
3. Press the **Enter** button when finished.

**NOTE:** An external keyboard, bar code scanner, or mouse can be used to enter data.

*Figure 42*

*Owner Data Screen*





## SERVICE DATA

*NOTE: Some functions are not available when the security switch is set to Secure mode due to governmental regulations and appear in a gray tone.*

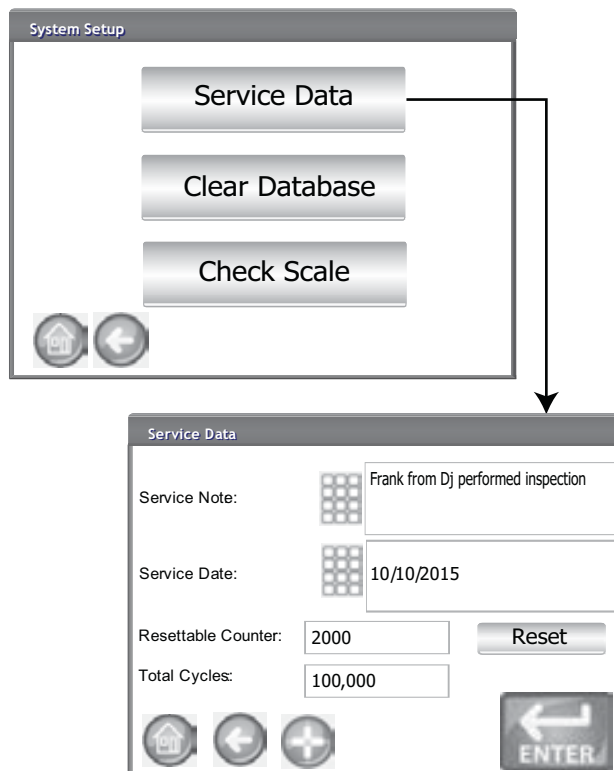
The Service Data screen provides text entry fields for technicians to enter comments regarding service performed on the unit and service date.

- Resettable Counter resets the number of tests to 0.
  - Total Cycles indicates the number of tests performed over the life of the unit and is not resettable.
1. At the System Setup screen, press the **More** button until the Service button appears.
  2. Press the **Service Data** button to display the Service Data screen.
  3. Enter notes and date by pressing the keypad icon.
  4. Press **Reset** button to set counter to 0, if desired.

*NOTE: An external keyboard, bar code scanner, or mouse can be used to enter data.*

*Figure 43*

*Service Screen*





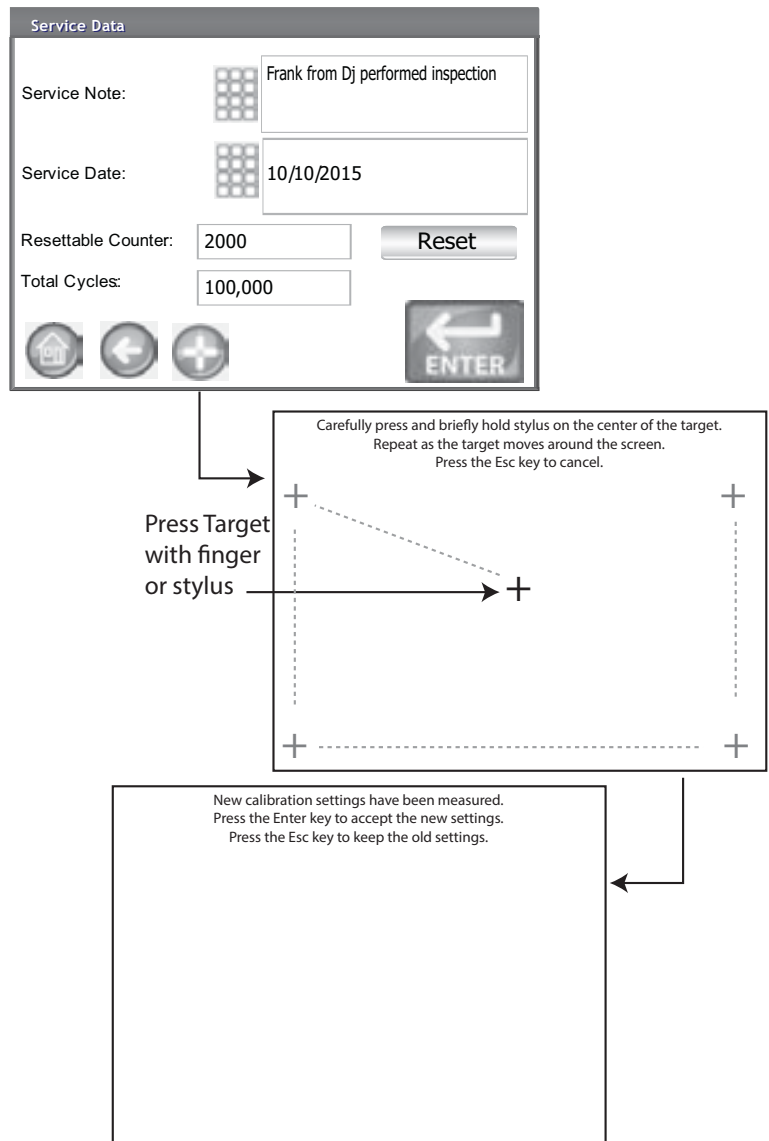
## LCD DISPLAY TOUCH SCREEN CALIBRATION

The LCD display touch screen may not respond as it should with a finger touch or stylus after a period of time or if subjected to extreme temperature changes. The display can be re-calibrated to improve responsiveness.

1. At the Service Data screen, press the **Display Touch Screen Calibration** button and follow onscreen instructions.
2. Carefully press and hold finger on the center of the target.
3. Repeat as the target moves around the screen.
4. With a keyboard attached, press the **Enter** button to accept new settings or the **Esc** button to keep previous settings. Without an attached keyboard, press anywhere on the screen to accept.

Figure 44

Display Calibration





## CLEARING A DATABASE

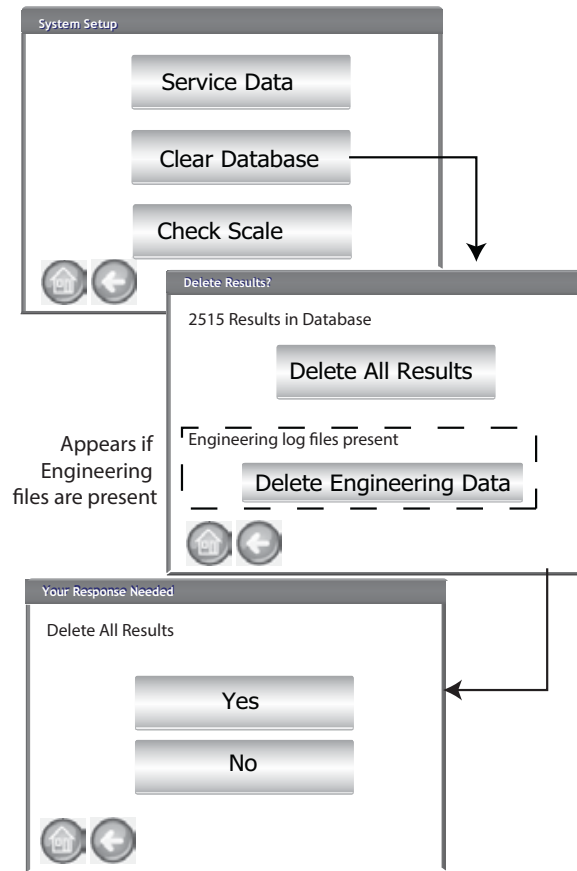
The unit is capable of storing a maximum of 3,000 test results. The database can be cleared at any time by selecting the Clear Database button located under the System Setup screen. When stored data has reached approximately 2,500 records, a warning screen automatically appears when attempting a grain measurement that indicates memory capacity is getting low. Analysis can still occur until the maximum allowed records of approximately 3,000 is reached. Once maximum storage is reached, grain analysis cannot continue until cleared.

### To Delete Records:

1. At the System Setup screen, press the **More** button until the **Clear Database** button displays.
2. Press the **Clear Database** button to display the Delete Results screen.
3. At the Delete Results screen, press the **Delete All Results** button.
  - A Delete Engineering Data button appears if Engineering log files are present. This button must be pressed to clear those records.
4. Press **Yes** to proceed with clearing records.
  - Press **No** to abort record deletion.

**NOTE:** Instruments with a Region set to Germany do not delete records less than 90 days old.

*Figure 45*  
*Memory Capacity Low Screen*





## CHECK SCALE

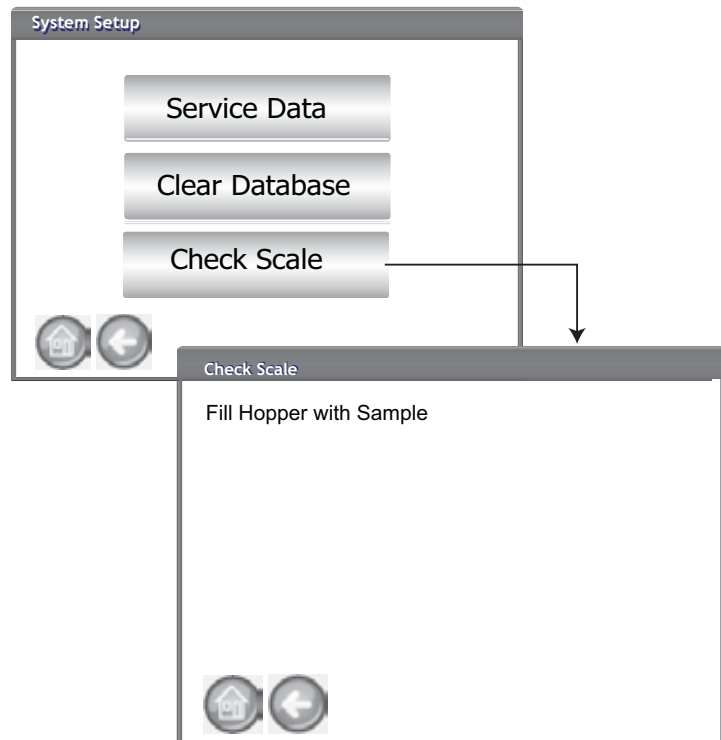
Check Scale performs an instrument scale measurement for a weight accuracy comparison with an external scale. The readings displayed onscreen are actual temperature and weight product results.

### To Perform a Check Scale:

1. At the System Setup screen, press the **More** button until the **Check Scale** button displays.
2. Press the **Check Scale** button to display the Check Scale screen.
3. Fill hopper with a sample. When the hopper is full, the next screen automatically displays.

*Figure 46*

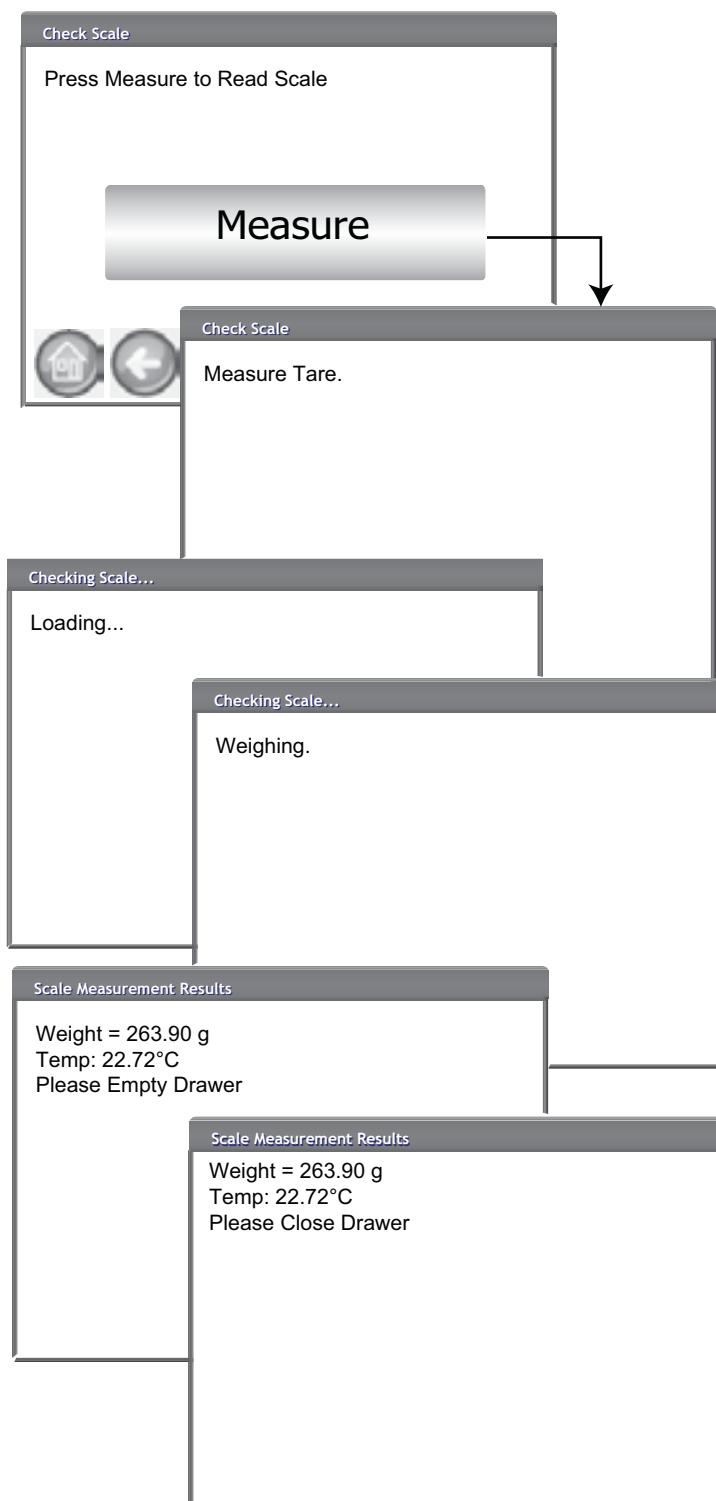
*Performing a Check Scale*



4. Press the **Measure** button to start the process.
  - This is the last screen that allows returning to the previous screen or returning to the Home screen.
5. Measurement process automatically begins measuring tare then loading and weighing the sample.
6. At the Scale Measurement Results screen, dump any excess material that fell into the drawer during the strike off process. The sample weight and temperature captured during the measurement appears on this screen.
7. Insert drawer into instrument.



Figure 47  
Performing a Check Scale

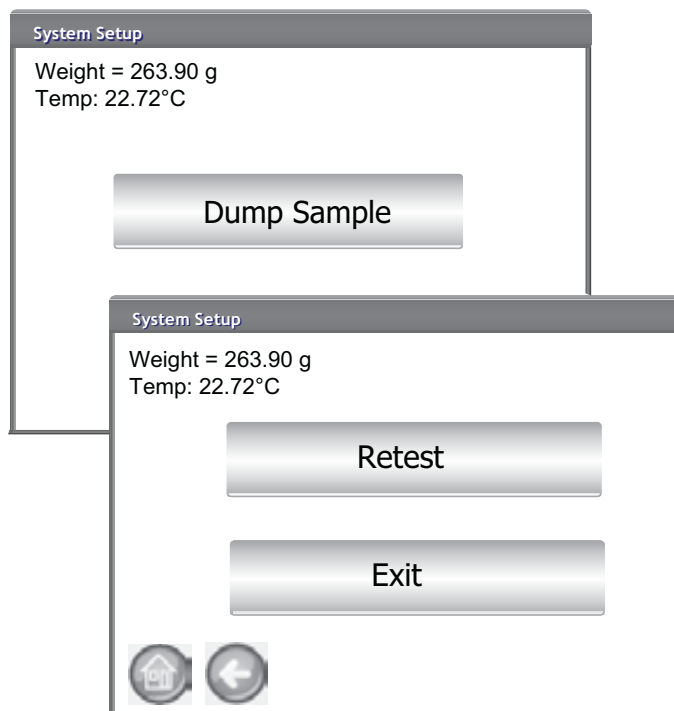




8. Press the **Dump Sample** button to dump sample into drawer.
9. Remove drawer and weigh the grain in the drawer on an external scale and compare to reading on the display.
10. Press the **Retest** button to perform another check scale or **Exit** button to return to the Setup screen.

*Figure 48*

*Dumping Sample*







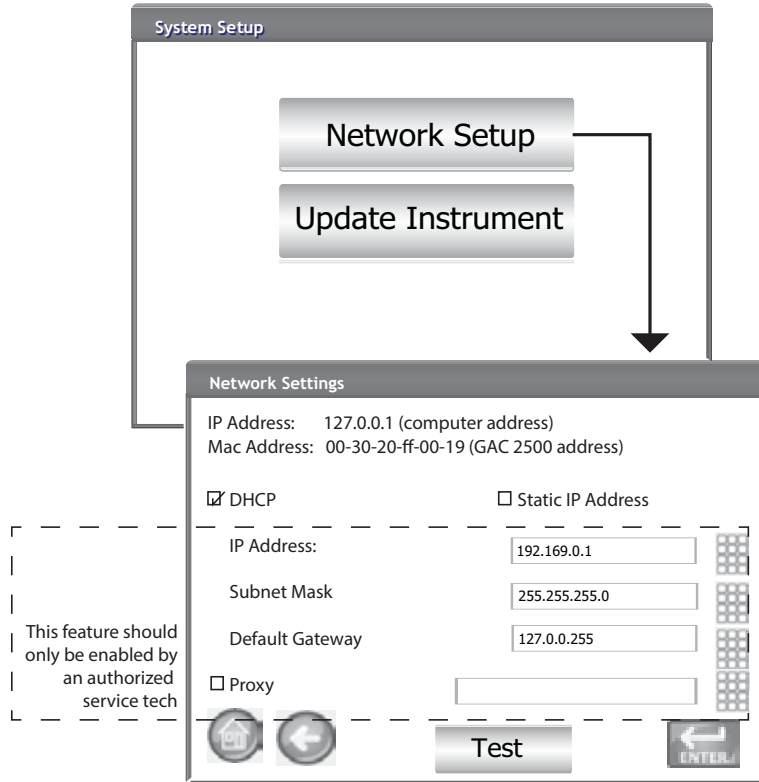
## NETWORK SETUP

Network setup automatically displays the ethernet settings of the instrument when connected to an ethernet cable and computer.

A Static IP address should only be enabled by an authorized service technician or by contacting DICKEY-john Tech Support.

Figure 49

Network Setup





## UPDATE INSTRUMENT

*NOTE: Some functions are not available when the security switch is set to Secure mode due to governmental regulations and appear in a gray tone.*

*NOTE: An instrument update can also be performed by connecting to a computer via an ethernet cable and using the USB Customer Updater tool found at [www.dickey-john.com](http://www.dickey-john.com).*

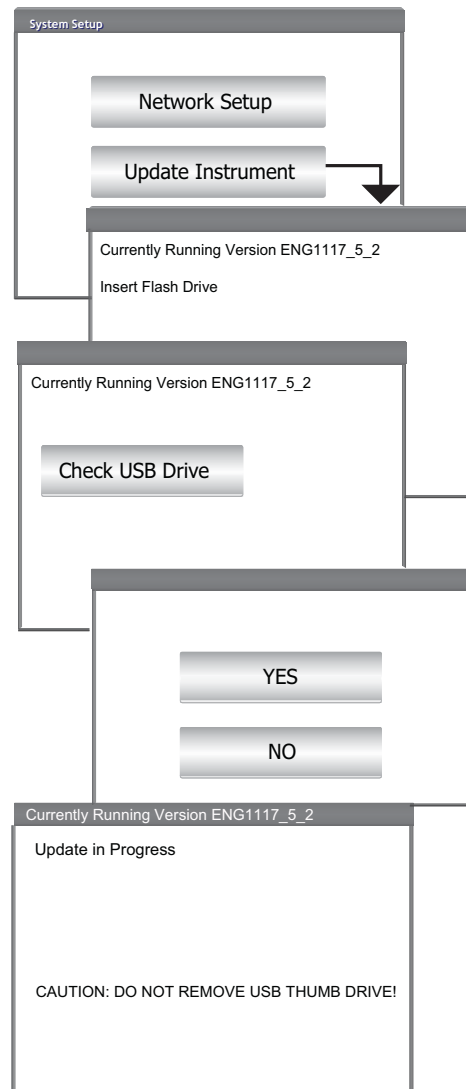
Update Instrument allows a software update to the instrument via a USB memory device. After an update, the instrument performs an automatic power cycle.

1. At the System Setup screen, press the **Update Instrument** button.
2. Insert the USB memory device and follow onscreen instructions.
3. Press the **Check USB Drive** button.
4. Press **Yes** to proceed with update.

**IMPORTANT: Do not remove USB memory device until update is complete.**

*Figure 50*

*Update Instrument*



# OPERATOR'S MANUAL

---



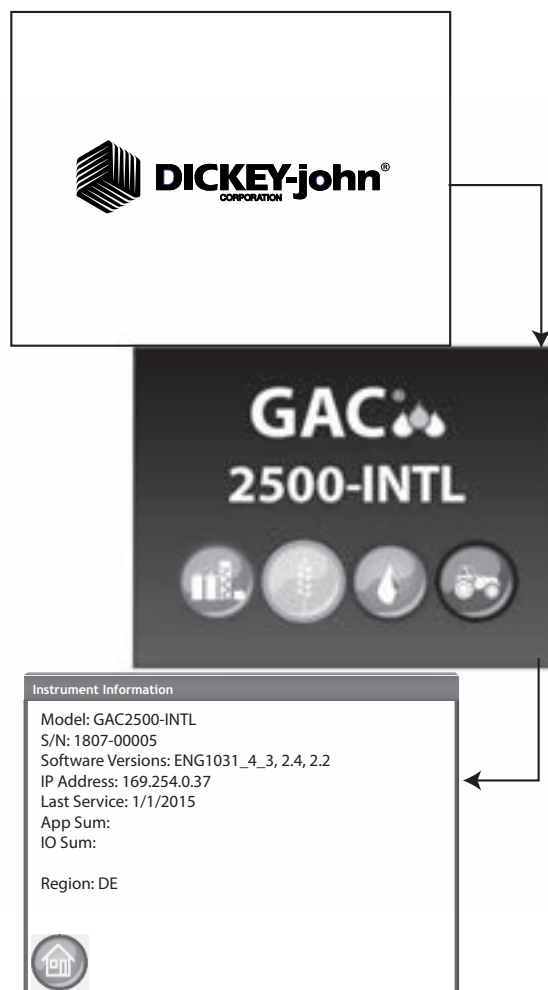


## STARTUP

The GAC<sup>®</sup> 2500 is powered on by pressing the on/off switch located on the front panel (Figure 1). A series of Startup screens load after the system is turned on. A status bar will indicate self checks are occurring and upon completion, the Instrument Information screen displays before the Main Menu screen appears.

**IMPORTANT:** On initial power up of the unit, the system defaults with open access to all screens. To ensure that the unit's settings are protected and accessible by qualified users, an administrative level with password should be created. Refer to the System Setup section for further information.

Figure 51  
Startup Screens





## POWER DOWN

The unit can be powered down from any screen by pressing the on/off switch located on the front panel.

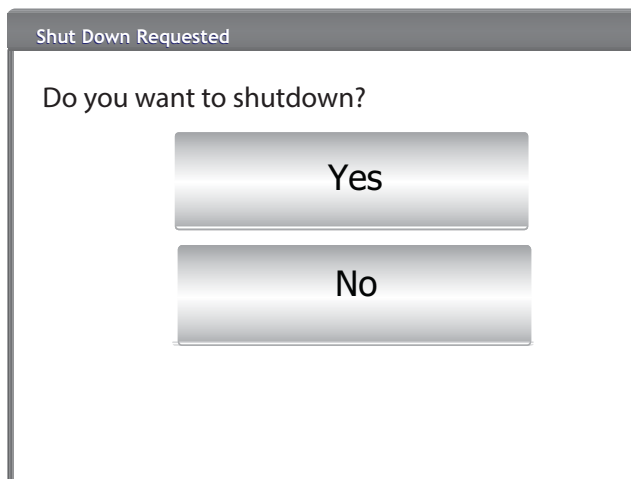
A virtual **Power Down** button is also available on some top level screens and powers off the unit in the same manner as the on/off switch.

A Power Down screen must be acknowledged before the unit shuts down.

*Figure 52*

*Power Down Screen*

---





## ANALYZING GRAIN

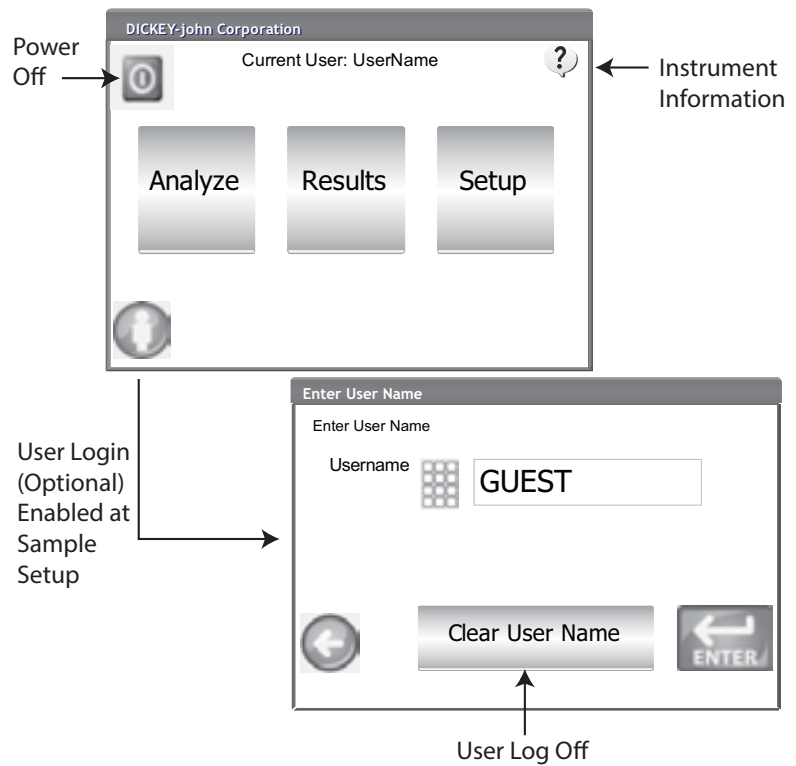
The Main Menu screen appears after all Startup screens have loaded. This is the "Home" menu through which all other menus are accessed.

At the Main Menu screen, three functions are performed:

1. To analyze grain
2. To access test results
3. To setup/customize the unit

Figure 53

Main Menu (Home) Screen



### USER LOGIN (OPTIONAL)

A User Login is an optional feature that requires a user to login before grain can be analyzed. The unit default is no user login required. If a user login is required, a **User** button appears on the Main Menu screen. The User cannot proceed to test grain until a login name is entered. The User Login feature records the user name with a grain test in the unit database and prints on each grain ticket.





**NOTE:** Refer to the System Setup, Sample Setup section to enable user login.

## USER LOGIN

1. At the Main Menu screen, press the **User** button.
2. GUEST appears as the default User Name and must be replaced with a different user name. Press the keypad icon to enter a new user name.

Figure 54

User Login Keypad



3. Press the **Enter** button to accept. The user name will appear as the current user on the Main Menu screen.

The unit will continue to analyze grain with the active user name until the user logs off or the power is turned off.

## USER LOG OFF

1. At the Main Menu screen, press the **User** button.
2. At the User Login screen, press the **Clear User Name** button. GUEST will default as the new user name.
3. Press the **Enter** button to return to the Main Menu screen.
4. A new user name must be entered before additional grain analysis is allowed.



## SELECTING PRODUCT

*NOTE: If User ID is enabled, it must be entered before analysis can occur.*

### To Select a Grain for Testing:

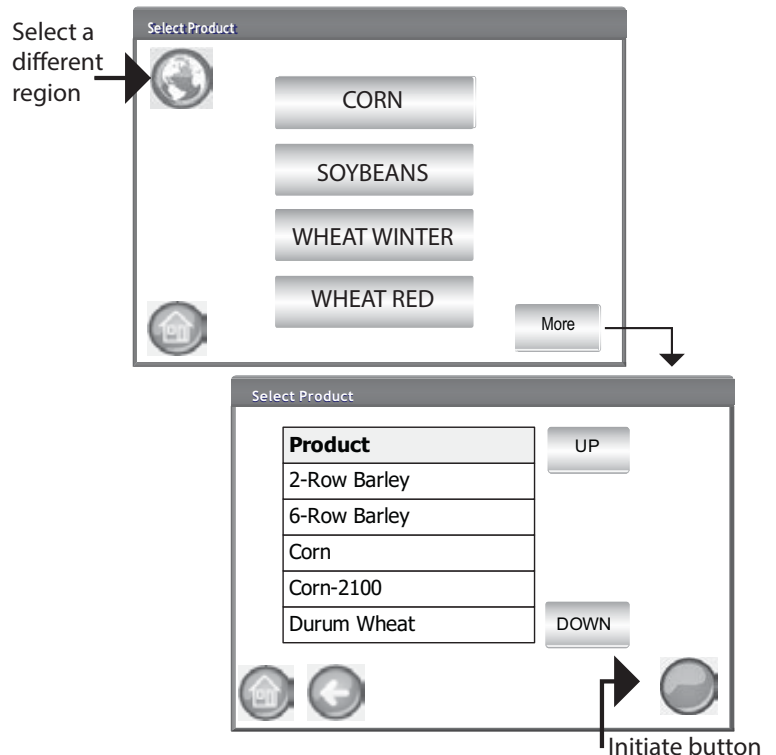
1. At the Main Menu screen, press the **Analyze** button.
2. A pre-defined list of 4 grains appear on the Select Product screen.
  - Grains are saved in a “last used” order.
  - A grain selected on the first Select Product screen proceeds to Sample ID screen or the Analysis screen.
3. To view additional grains not viewable on the top level Select Product screen, press the **More** button.
  - Press the **Up** and **Down** buttons to view grains.
  - Select the desired grain in the product table.
  - Once selected, press the **Initiate** button to accept.
4. Grain is ready for analysis.

**IMPORTANT: Instruments with a Region set to Canada use a Test Weight reference point based on the Avery bushel. U.S. instruments use a reference point based on the Winchester bushel.**

*NOTE: Change the region setting on the Select Product screen by pressing the **Region** button.*

*Figure 55*

### Select Product







## REGION CHANGE

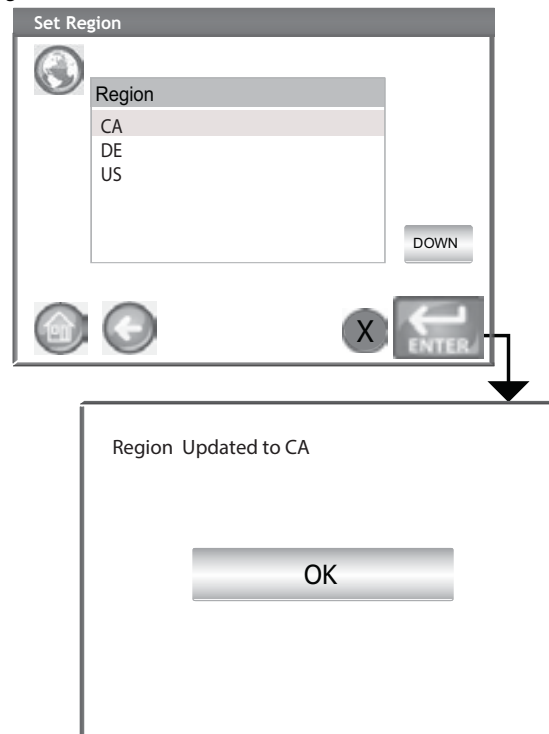
The Region on the GAC 2500-INTL can be quickly changed prior to analysis.

### To Change Region:

1. At the Select Product screen, press the **Region** button.
2. Select the desired region at the Set Region screen.
3. Press the **Enter** button to accept.
4. Press **OK** button to acknowledge change.

Figure 56

Region Change on GAC 2500-INTL



## PERFORMING A GRAIN ANALYSIS

Screens that display during analysis will vary based on what configurations are enabled or disabled at the System Setup/Sample Setup screens:

- Automatic grain measurement when hopper is full
- Sample ID and/or Customer ID screen prompt step
- User Login requirement
- Empty drawer requirement after each test

*NOTE: To eliminate this screen before each analysis, disable at the Sample Setup screen.*

### To Begin Analysis:

1. If enabled, the Enter Sample ID screen appears. The selected product and Issue ID displays at the top of the screen.
  - **Change Product** button allows selection of a different product.
  - **Dump** button dumps product from the hopper.

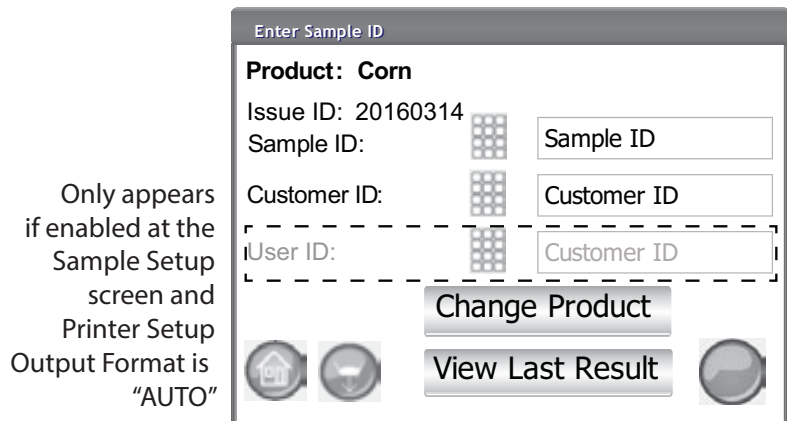


2. A Sample ID name can be entered by pressing the keypad located next to the input box.
  - If automatic number sequencing is enabled, the next higher number is automatically entered with additional tests of the same grain (1,2,3, etc). If auto sequence is not selected, the previous tests sample ID is cleared.
  - A Sample ID number must be entered as a positive number (1, 1.1) or a positive integer (1, 100).
3. A Customer ID can be entered by pressing the keypad located next to the input box.
4. Enter a User ID, if required. (for federal agencies)
5. Press the **Initiate** button to proceed.
  - If the automatic measure feature is enabled, instrument automatically proceeds.
6. Pour grain into the hopper heaping grain slightly up to the hopper full sensors.

*NOTE: Non alphanumeric keys cannot be used to create an Issue ID, Product Name, or Sample ID (examples include: &, \*, /, #).*

*Figure 57*

*Sample ID Screen*



## **CAUTION**

**Do not insert fingers or foreign objects into the opened hopper doors.**

## HOPPER LEVEL INDICATOR

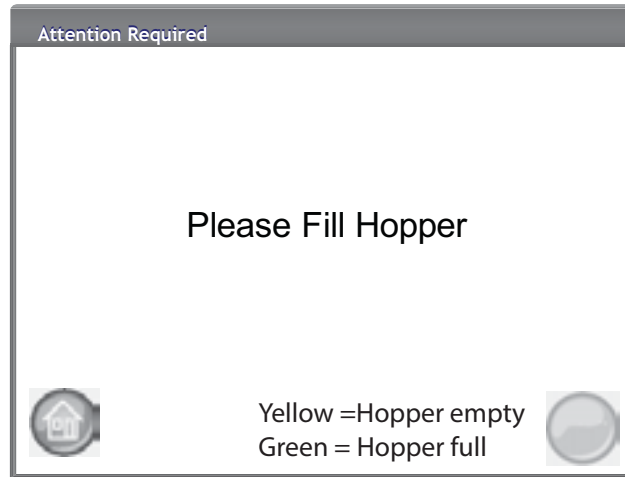
**IMPORTANT:** It is important that ample grain is located in the hopper to fill the measuring cell. This increases the accuracy of the instrument. A yellow button indicates that either the hopper is empty or does not contain enough grain to fill the hopper. Add more grain.

During analysis, hopper level status is indicated via the **Initiate** button.

- Yellow indicates hopper is empty and must be filled before proceeding.
- Green indicates hopper is full and testing can proceed.

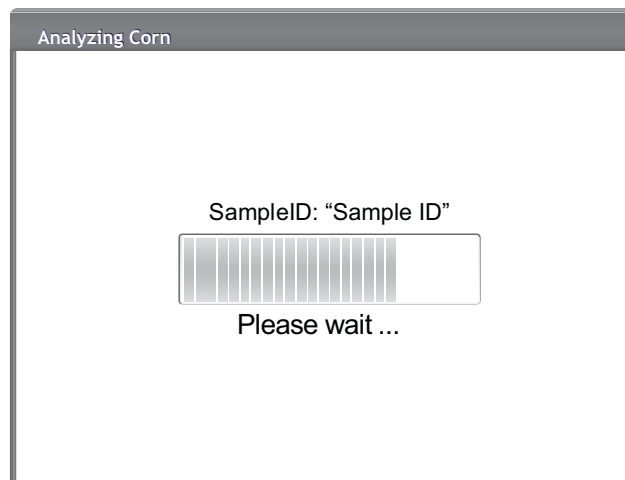


Figure 58  
Hopper Level Indicator



7. Press the **Initiate** button (green) to begin test. Grain will dump into the measurement cell from the hopper. A test will only perform when the **Initiate** button is green.
  - If the automatic measure feature is enabled at the Sample Setup screen and the hopper is full, instrument automatically proceeds to measure a sample skipping the Fill Hopper screen and eliminates pressing the **Initiate** button.
8. The cell fills and the striker arm swings across the top of the test cell to wipe away excess grain.
9. During analysis, a testing status bar indicates progress.

Figure 59  
Analysis Process



10. An audible alarm indicates when test is complete and automatically advances to the Analysis Results screen.



*NOTE: To automatically return to the Sample ID screen without pressing the **Initiate** button refer to the System Setup, Results Setting section for enabling Automatic Return.*

11. The Analysis Results screen displays:
  - Product tested
  - Sample name
  - Moisture content % (\* indicates certified and based on region setting)
  - Test Weight lbs/bu or kg/hl (optional) (An asterick (\*) may appear that indicates a certified test weight based on the active selected region)
  - Temperature (optional)
12. Test results are automatically saved to the unit.
13. If the unit is set to manual advance after each analysis, press the **Initiate** button to initiate another test.

Grain automatically dumps into the drawer for removal in Manual or Automatic advance.

- A requirement that grain be dumped after each test can be enabled at the Result Setup screen.

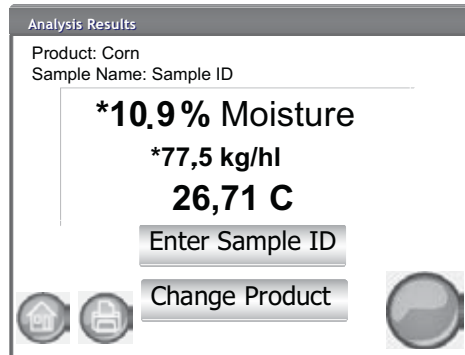
Drawer capacity holds approximately 3 tests. After 3 tests the drawer must be emptied before proceeding.

**IMPORTANT: When using a bottomless grain drawer with flow-through counter, the bottomless drawer feature should be enabled under System Setup, Result Settings to perform unlimited grain tests to eliminate error messages.**

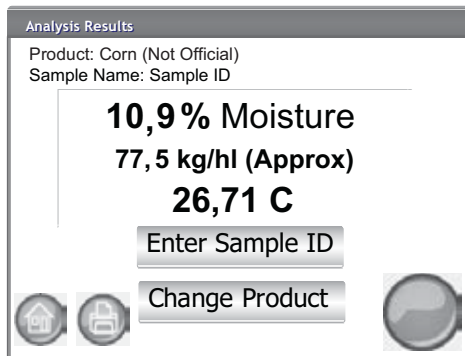
Grain will not dump out of the cell if drawer is not present or secure.



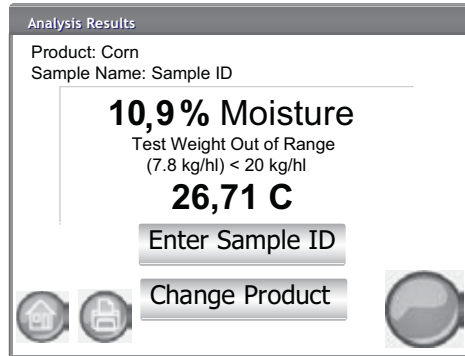
Figure 60  
Analysis Screen



Certified TW  
(An asterick (\*)  
may appear for  
certain regions  
next to moisture  
and test weight  
readings.



Not Official and/or  
Approx may appear  
next to Test Weight  
for certain regions  
for an unofficial test  
weight.



TW Out of  
Range



**Other Actions:**

- **Print** button sends test results to a local printer.
- **Home** button returns to the Main Menu screen.
- **Enter Sample ID** button to enter a Sample ID for next analysis. Does not allow changing the current Sample ID.
- **Change Product** button allows quick selection of a new product.

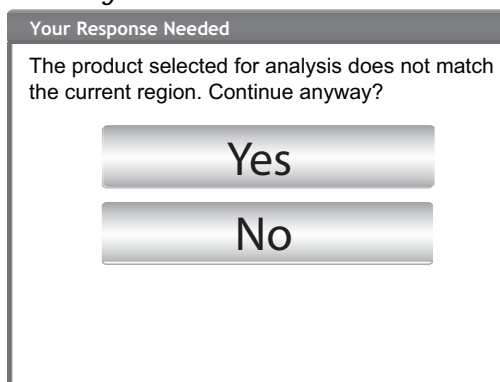


## REGION MISMATCH WARNING

If a calibration is selected that is not in the currently selected region, a warning screen must be acknowledged to proceed with the analysis. The calibration will be added to that region's product list but a warning screen will always appear and must be acknowledged to proceed with analysis.

*Figure 61*

*Region Mismatch Warning*





## APPROXIMATE CALIBRATION READING

An approximate/not official reading, if set to metric, that displays on the Analysis screen might be the result of an old calibration installed on a new instrument; typically a custom calibration.

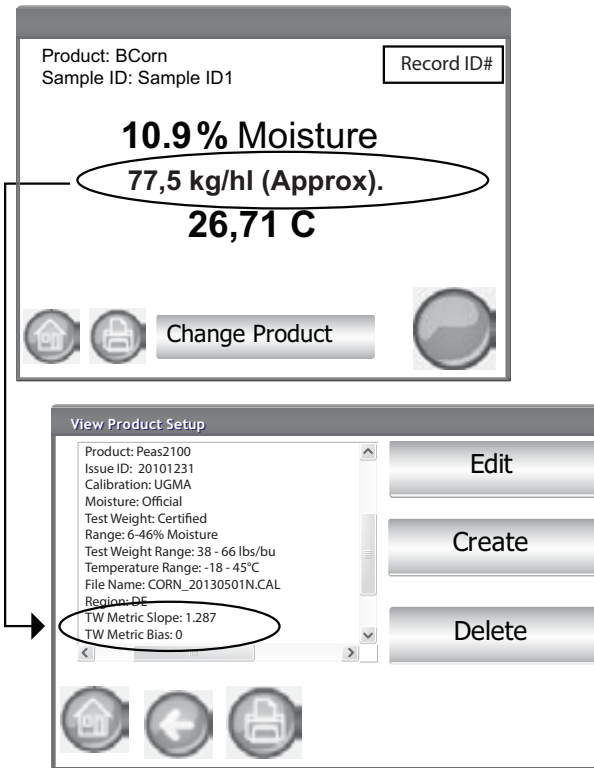
*TIP: If an approximate reading is not expected, go to the Edit Product screen. If TW Metric Slope and TW Metric Bias do not appear on screen as a line item then the calibration is old. Or if TW Metric Bias value is 0 the calibration is old.*

**NOTE:** A **certified** calibration on all GAC 2500 models that has been altered from its original state and renamed will result in the test weight appearing as "approximate" on both lb/bu or kg/Hl readings.

Contact DICKEY-john Technical Support for assistance on how to update the calibration.

Figure 62

Custom Calibration Reading



**NOTE:** Refer to the Error Message section for probable causes and corrective actions if errors occur during analysis.

**NOTE:** Refer to the Save Results section and Printing Options section for output options.

## GENERAL CLEANING TIP

Some material accumulation around the measuring cell can possibly occur over time and could possibly affect measurement results.

It is recommended the unit be regularly cleaned to ensure continued and consistent results. Refer to the Maintenance section for cleaning steps.



## DATABASE MEMORY MESSAGES

### DATABASE MEMORY FULL WARNING

When stored data has reached approximately 2,500 records, a warning screen automatically appears when performing a grain analysis indicating memory capacity is getting low. Analysis can still occur until the maximum allowed records of approximately 3000 is reached.

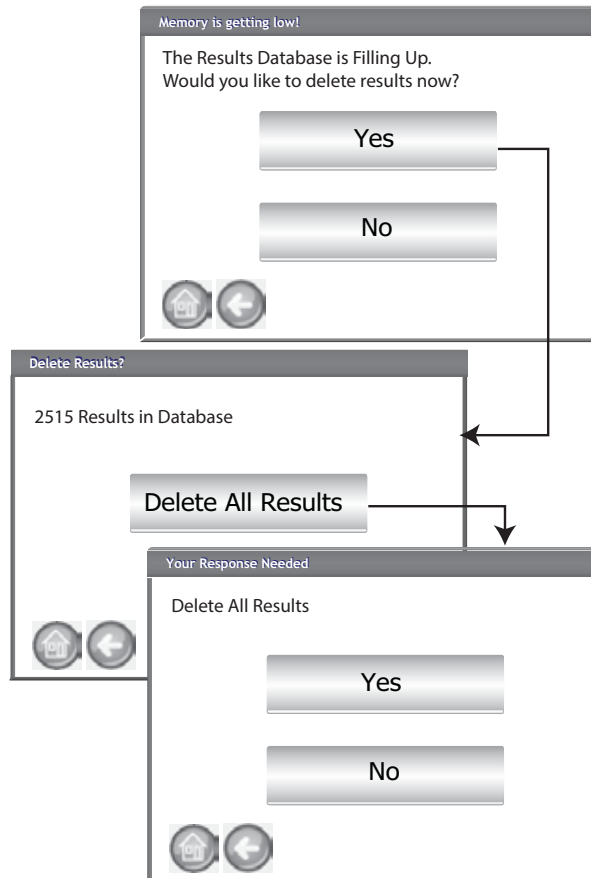
*NOTE: Records cannot be exported to a USB memory device at this screen. If a backup is required, this can be accomplished at the View Results screen found under the Results button.*

#### To Clear Database Records:

1. At the Memory Low screen, press **Yes** to delete results.
  - Select **No** to return to previous screen and abort deleting records.
2. At the Delete Results screen, the number of records in the database is indicated. Press the **Delete All Results** button to confirm record deletion.
3. Press the **Yes** button to verify and begin deleting records.
  - Select **No** to return to previous screen and abort record deletion.

*Figure 63*

*Clear Database Screen*





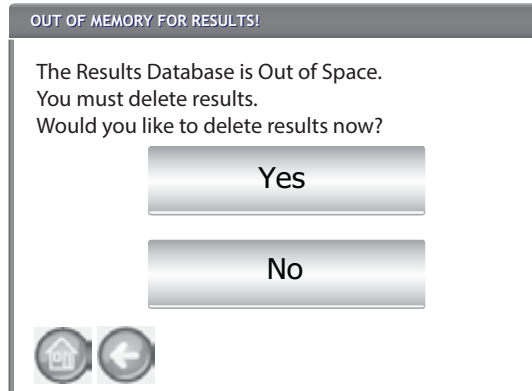


## OUT OF MEMORY

A Database Full screen displays when performing a grain analysis and the database has reached maximum storage capacity. Analysis cannot continue until records are deleted. Follow onscreen instructions to remove records.

*Figure 64*

*Out of Memory*

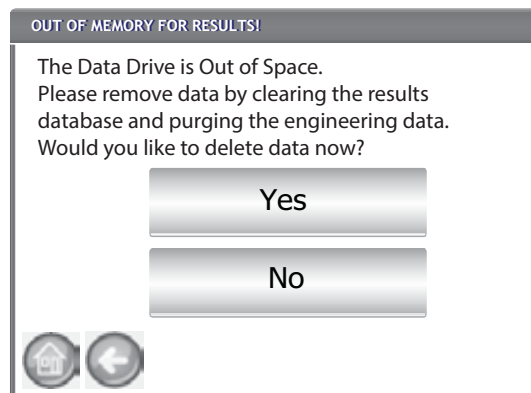


## DATA DRIVE OUT OF MEMORY

A Data Drive Out of Memory screen appears when the data drive is out of space. An analysis cannot be performed until data is cleared.

*Figure 65*

*Data Drive Out of Memory Warning*





## RESULTS

The Results screen provides access to grain test results, product list, and audit trail.

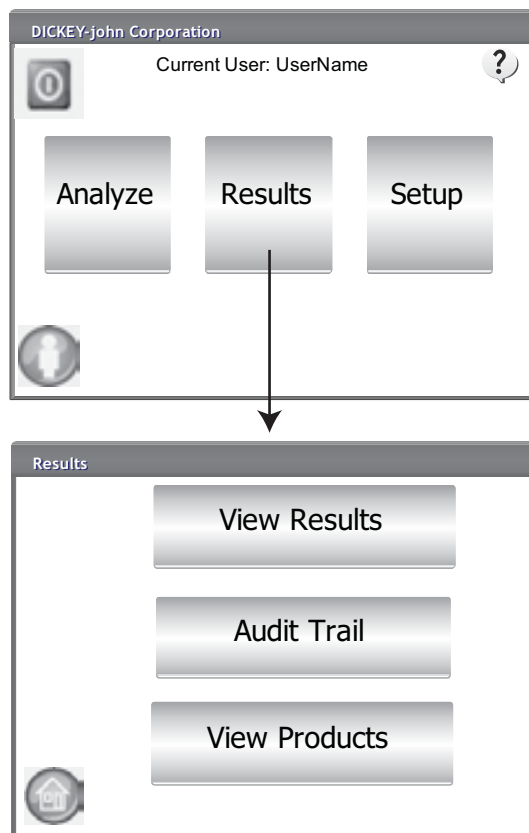
### To View Test Results:

1. At the Main Menu screen, press the **Results** button.
2. At the Results screen, press the **View Results** button.

*NOTE: A momentary pause may occur before test results appear on screen. Do not press any buttons during this time.*

Figure 66

View Results



3. The Results screen default displays all test results with Sample ID, % Moisture, Weight, Temperature, Product, Issue No., Customer ID, User ID, Date and Time.
4. Press the **Filter** button to choose what events display on the test results record. Refer to Refine Query Options for criteria options.
5. Press the **Print** button to print results as displayed in the table on the Results screen.
6. Insert USB memory device and press the **USB** button to transfer product results to a computer. All results are transferred to USB regardless of Filter setting.

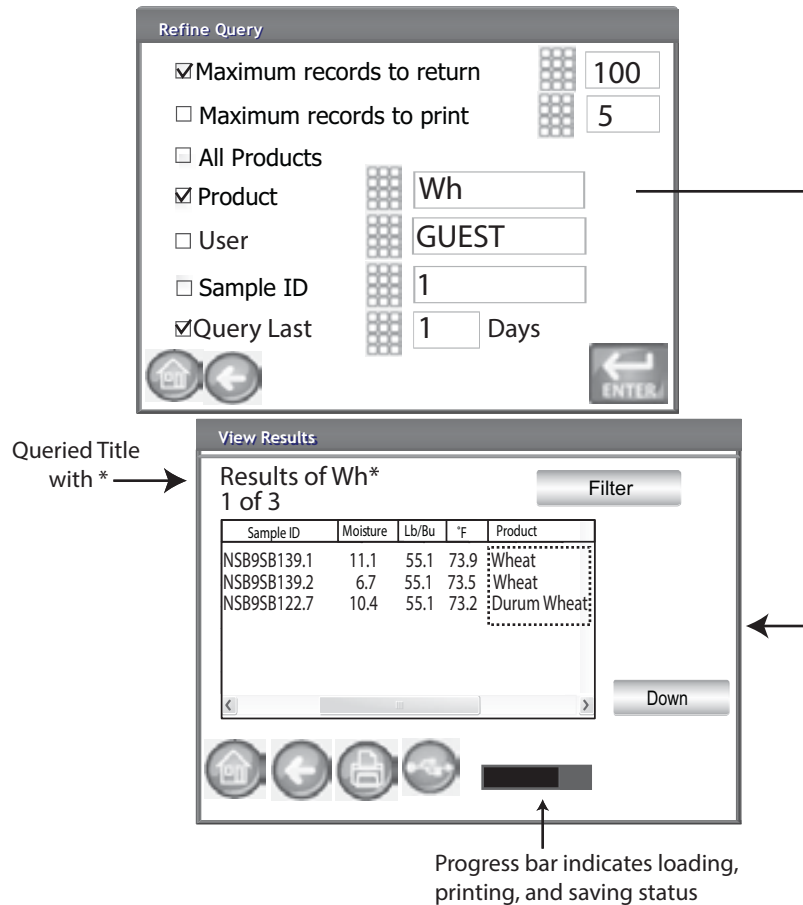




## REFINE QUERY OPTIONS

Figure 67

Product Like Criteria Example



Results can be filtered to display based on one or all of the following criteria:

### MAXIMUM RECORDS TO RETURN

Allows entry of a specified number of records to query so that only a specific last number of records are returned. When the Query Last option is checked, the title of what is queried will contain an asterisk to indicate that all returned results are displayed per the limit of records entered but there could be more older records in the database that meet the same criteria.

### MAXIMUM RECORDS TO PRINT

Allows entry of a specified number of records to print starting with the last sample taken, such as printing the last 5 samples taken.



*NOTE: A status bar indicates progress of retrieving filtered data. Results can take several minutes to load while retrieving data. Do not press any buttons during this time.*

*NOTE: User and Sample ID filter function works the same as the Product filter. Refer to (Figure 67)*

## ALL PRODUCTS

Displays all sample tests stored on instrument.

## PRODUCT

Allows entry of part or all of the product name to perform a product search. All records that fit criteria entered in the Product Like filter search will display. Example: Searching for a product like "Wh" searches for all records with "Wh" in the product name. (Figure 67) displays results for Wheat and Durum Wheat.

## USER

Allows entry of part or all of the User name to perform a search for similar records within the User field. All records that fit the criteria entered in the User filter search will display.

## SAMPLE ID

Allows entry of part or all of the Sample ID name to perform a search for similar records within Sample ID. All records that fit the criteria entered in the Sample ID filter search will display.

## QUERY LAST

Displays the last number of days specified. All records that fit the criteria entered will display.

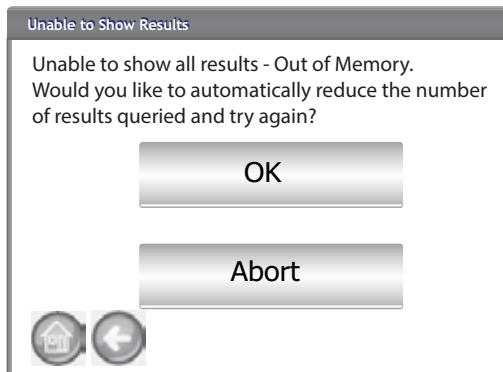
## UNABLE TO SHOW QUERY RESULTS

When the system has reached near memory storage capacity, a query might not be able to display results per the number of records entered on the Query screen. In this instance, a screen confirmation will require the query be performed at a reduced number than was entered on the Query screen.

- Press **OK** to run query at reduced number
- Press **Abort** to cancel and return to Home screen.

*Figure 68*

*Unable to Show Results Screen*





## AUDIT TRAIL

Any changes that relate to system functionality and testing are recorded and stored. The Audit Trail provides a log of these changes.

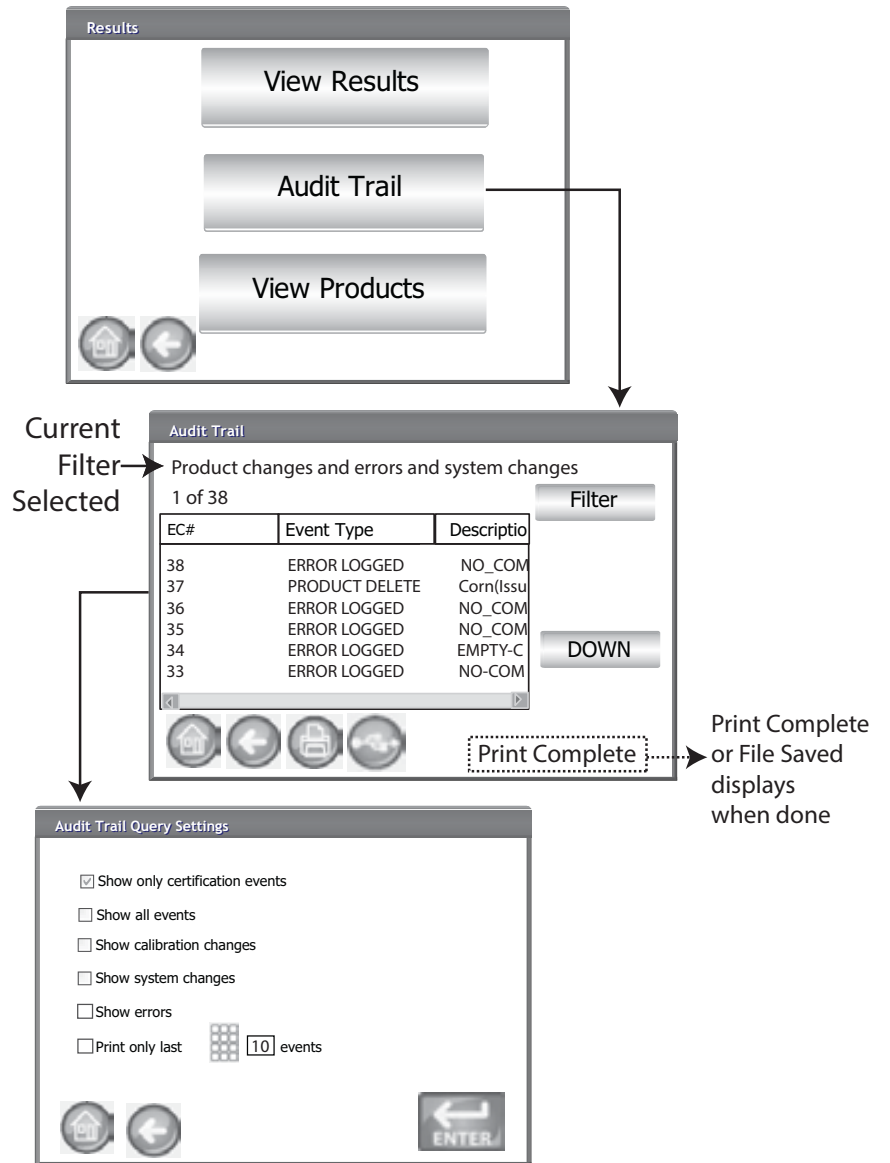
### To View Audit Trail:

1. At the Results screen, press the **Audit Trail** button.
2. The Audit Trail screen displays
  - Event Counter (EC#) (number assigned to each change)
  - Event Type
  - Description
  - User
3. Press the **Filter** button to choose what events display on the Audit Trail record.
  - Show only certification events (when selected, all other options are unchecked)
  - Show All Events (when selected, all other options are unchecked)
  - Show Calibration Changes
  - Show System Changes
  - Show Errors
  - Print only a certain number of events
4. Press the **Print** button to print results as displayed on the Audit Trail screen. If the printer output format is PRN80, PRN81, CSV01, the output format is CSV. All other formats print in strip.
5. Insert a USB memory device and press the **USB** button to transfer Audit Trail results as displayed on the Audit Trail screen to a file for transfer to a computer.





Figure 69  
Audit Trail





## VIEW PRODUCTS

The Installed Products screen provides an alphabetical table of active products stored on the unit with respective Issue ID. Products can only be viewed and printed at this screen.

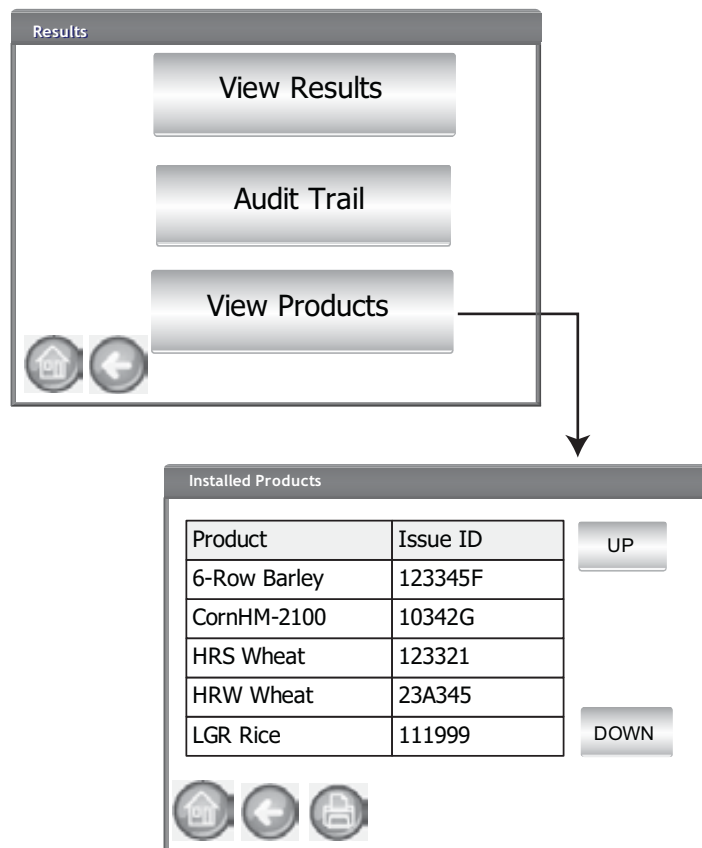
### To View Products:

1. At the Results screen, press the **View Products** button.
2. Press the **Print** button to print all active products and respective Issue ID's.



Figure 70

View Products Screen





## GRAIN CALIBRATIONS

Grain calibration files are available for download at the DICKEY-john website for transfer to the GAC<sup>®</sup> 2500 via a USB memory device.

*[www.dickey-john.com/Products/Analytical/Moisture Testing/GAC2500 Grain Analysis Computer/Get Support/Downloads](http://www.dickey-john.com/Products/Analytical/Moisture%20Testing/GAC2500%20Grain%20Analysis%20Computer/Get%20Support/Downloads)*

These files are also available through DICKEY-john Technical Support Group at 1-800-637-3302.







## DIAGNOSTICS

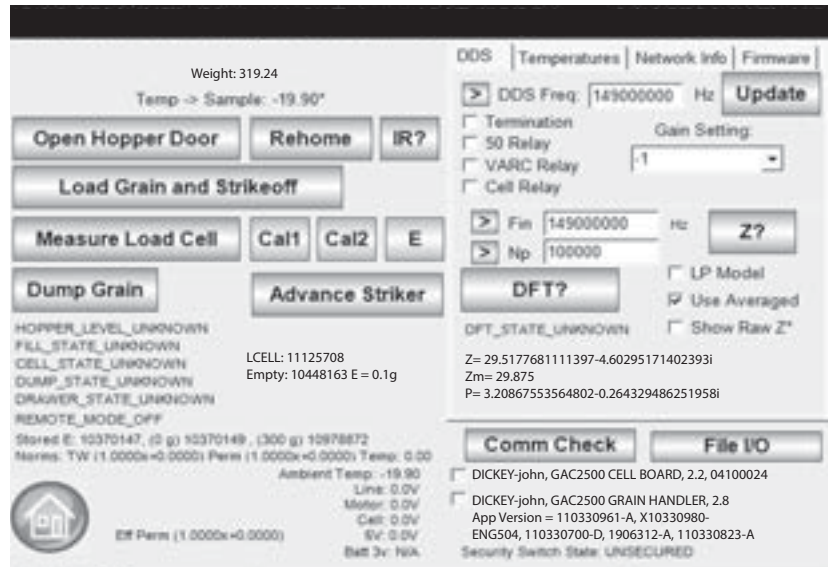
The Diagnostics screen is typically used by trained service technicians to perform various functions and for troubleshooting purposes. It is recommended that the functions on this screen are performed by a DICKEY-john representative.

### To View Diagnostics Screen:

1. Press the **Setup** button to display the Setup screen.
2. Press the **Diagnostics** button to view the Diagnostics screen.

Figure 71

Diagnostics Screen







## MAINTENANCE

*NOTE: For customers that require a more extensive cleaning procedure with debris buildup in the cell, contact and schedule your instrument for cleaning with your dealer or authorized service center.*

**IMPORTANT: It is highly recommended the unit be regularly inspected and cleaned to ensure continued and consistent results.**

**For optimum performance, extensive cleaning should be performed weekly or more often, as needed, based on surrounding environmental conditions. Factors such as dust, temperature extremes, grain dust, and external humidity vary from location to location. If there are any questions about the cleanliness or instrument performance, contact your local authorized service center.**

Note: The following recommendations are provided as a guideline to maintain a robust and quality operating instrument. It should not be interpreted as an exhaustive maintenance program. Dust and debris may periodically accumulate in areas not specified in this manual. The owner is responsible for ensuring overall equipment cleanliness. If any questions arise regarding the maintenance or performance of the instrument, contact your dealer or local authorized service center.

## EXTERNAL CLEANING

The LCD display may require periodic cleaning. Use a commercial cleaner for glass lenses to remove dust.

### CAUTION

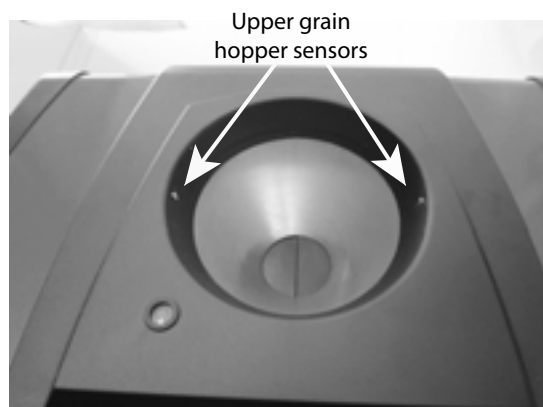
**Do not apply water, organic solvent or chemicals, such as acid and alkali to the LCD display.**

The GAC<sup>®</sup> 2500 surface can be cleaned with any cleaner designed for plastic and stainless steel surfaces.

Periodically use a rag to wipe the grain hopper and the (2) upper grain hopper sensors.

*Figure 72*

*Grain Hopper Sensors*





## INTERNAL CLEANING

Performing continuous tests can result in material accumulation around the critical internal components and adversely affect the measurement.

Two types of cleaning are recommended on an as needed basis:

- Daily clean
- Extensive clean

### DAILY CLEAN METHOD

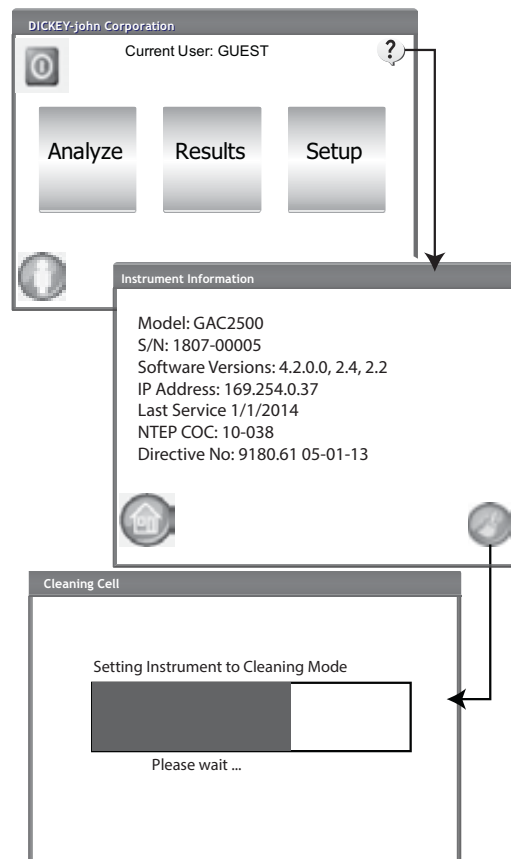
A daily clean method allows cleaning the cell and door using an automated process. During the cleaning sequence, the hopper door automatically opens. Instruments with version 2.4 grain handler firmware, the trap door opens automatically also.

#### To start the cleaning process:

1. At the Main Menu screen, press the **Instrument Information** button.
2. At the Instrument Information screen, press the **Clean** button.
  - Pressing the **Clean** button automatically begins the cleaning sequence and opens the hopper door and the trap door (version 2.4 grain handler firmware).

*Figure 73*

*Daily Clean Method*





3. Remove the grain drawer.

*Figure 74*

*Remove Grain Drawer*



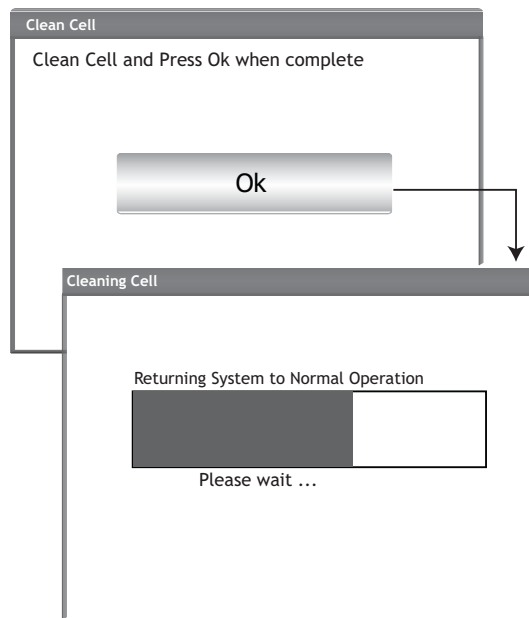
4. Using the supplied brush, manually remove any loose or stuck grain or dust from the measuring cell.
5. Press the **OK** button to return instrument to normal operation.

**CAUTION**

Hands should be clear from inside the instrument before pressing the OK button.

*Figure 75*

*Cleaning Sequence*



6. Insert grain drawer.



**NOTE:** For customers that require a more extensive cleaning procedure with buildup in the cell, contact and schedule your instrument for cleaning with your dealer or authorized service center.

## EXTENSIVE CLEANING METHOD

The daily cleaning method should be performed first before proceeding to the extensive cleaning method.

### IMPORTANT:

**Extensive cleaning should be performed weekly or more often, as needed, based on surrounding environmental conditions. Factors such as dust, temperature extremes, grain dust, and external humidity vary from location to location. If there are any questions about the cleanliness or instrument performance, contact your local authorized service center.**

Tools required for internal mechanism cleaning:

- Brush p/n 206410003 (included with instrument)

Extensive cleaning of the instrument involves two steps to ensure optimum instrument performance:

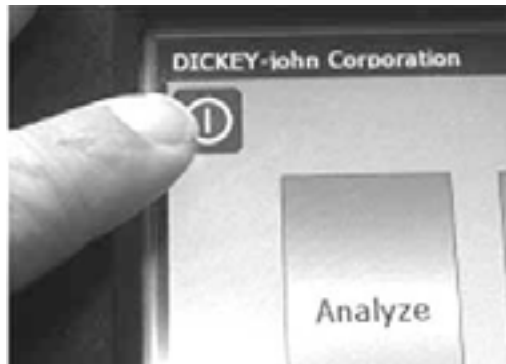
1. Internal mechanism cleaning
2. Temperature sensor probe cleaning

### To Clean the Instrument:

1. Power down the instrument.

*Figure 76*

#### *Power Down*



2. Unplug power cord.

*Figure 77*

#### *Unplug Power Cord*





3. Remove other accessory cords (USB and printer).

*Figure 78*

*Remove Accessory Cords*

---



4. Remove grain drawer.

*Figure 79*

*Remove Grain Drawer*

---



5. Place the instrument on its back side.

**IMPORTANT: Be careful when placing on back to avoid damage to security switch.**

*Figure 80*

*Place Unit on Back Side*

---







6. Manually pull down on trap door.

*Figure 81*

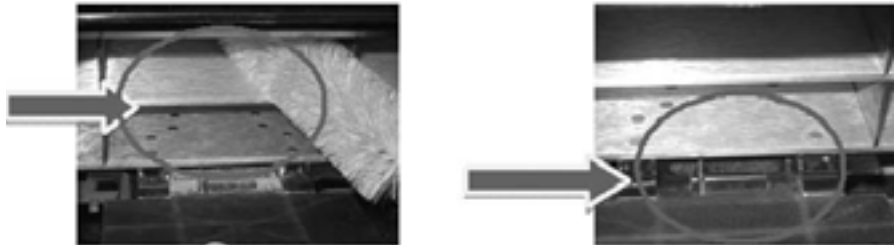
*Pull Down on Trap Door*



7. Clean surfaces around measurement cell including hinge, trap door, and edge of cell with the supplied brush.

*Figure 82*

*Clean Surface Area Around Cell, Hinge, Trap Door, Edge of Cell*



8. Close the trap door and clean hinge under trap door with brush.

*Figure 83*

*Clean Under Trap Door*



9. Proceed to instruction for cleaning the temperature sensor probe.



## CLEANING THE TEMPERATURE SENSOR PROBE

**IMPORTANT:** Any particles in front of the sensor's optics can affect measurement performance. Therefore it is crucial to sufficiently clean the sensor. For excessive dust and/or foreign material buildup on or around the temperature sensor, it is recommended the instrument be returned to **DICKEY-john Service** or authorized service center.

The temperature sensor may require cleaning due to dust buildup and/or foreign material that has collected around the sensor that could potentially cause temperature error readings during analysis. Temperature sensor cleaning should be performed weekly or more often, as needed, based on surrounding environmental conditions. Factors such as dust, temperature extremes, grain dust, and external humidity vary from location to location. It is important the temperature sensor is visually inspected and cleaned each time a regular maintenance check of the instrument is conducted. If there are any questions about the cleanliness or instrument performance, contact your local authorized service center.

Tools required for cleaning the temperature sensor probe:

1. One of the below cotton swabs:
  - Standard 6" long cotton swab (i.e. McMaster-Carr p/n 7074T12) for flush sensor
  - 6" long, tapered tip cotton swab (i.e. McMaster-Carr p/n 71035T54) for embedded sensor

*Figure 84*

*Recommended Cotton Swab for Flush Sensor*



*Figure 85*

*Recommended Cotton Swab for Embedded Sensor*



2. 99% Isopropyl Alcohol

*Figure 86*

*99% Isopropyl Alcohol*



3. 10" flat head screw driver (only for instruments with flush sensor/brush bracket)



Figure 87

10" Flat Head Screw Driver



## TEMPERATURE SENSOR TYPE

The GAC 2500 is equipped with one of two different sensor types. The cleaning method is similar for both types however the cotton swab for cleaning varies based on the sensor type.

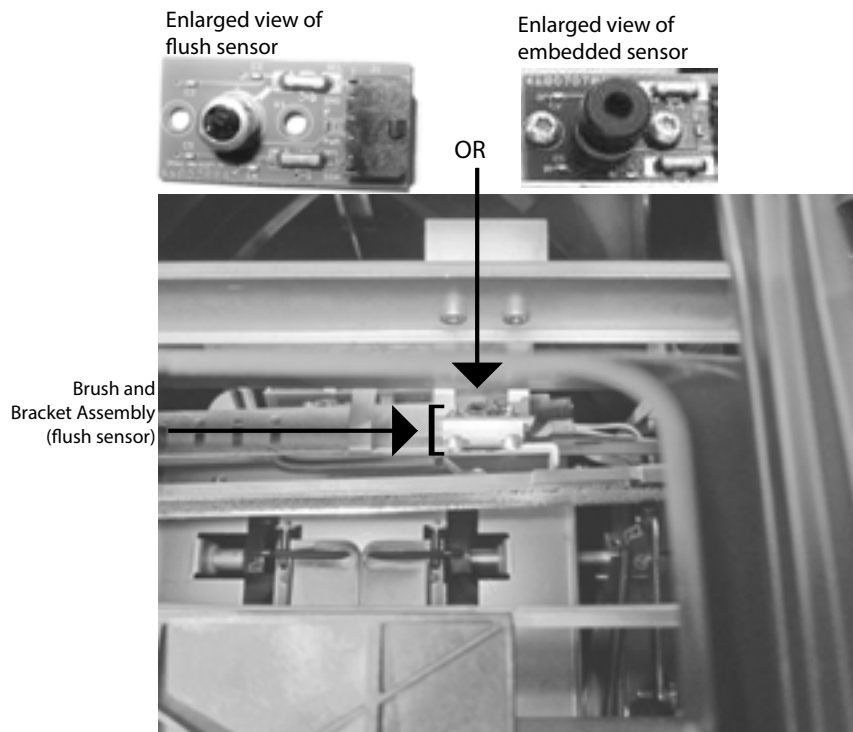
- older instruments may include an embedded sensor on the circuit board (recommended cotton swab McMaster-Carr p/n 71035T54)
- newer instruments include a flush sensor on the circuit board and a brush bracket (recommended cotton swab McMaster-Carr p/n 7074T12 )

## TEMPERATURE SENSOR LOCATION

With the instrument placed upside down and looking inside the instrument, the sensor probe is located in the middle of the instrument toward the top and front attached to a circuit board.

Figure 88

Sensor Probe Location



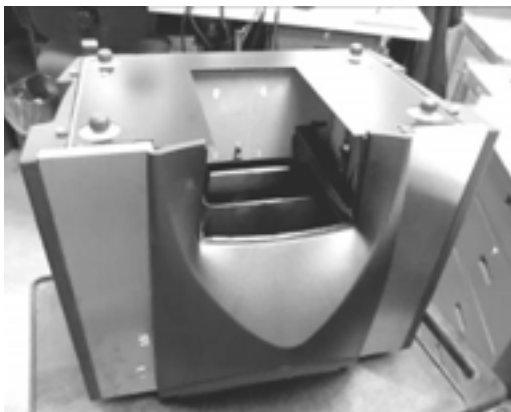


## To Clean the IR Temperature Sensor:

1. Gently place instrument upside down.

*Figure 89*

*Place Instrument Upside Down*



2. Visually inspect the IR temperature sensor to determine the type of sensor installed.
3. For instruments with the flush sensor and brush bracket, the following procedure can be utilized to remove particles from the brush. Carefully place the head of the screw driver (10" length recommended) at the bristles and use a sweeping side-to-side motion through the entire length of the bristles no fewer than three times.

*Figure 90*

*Cleaning the Brush Assembly*



4. Select the appropriate cotton swab as described. Wet one end of the cotton swab with 99% Isopropyl alcohol.



*Figure 91*

*Wet Swab with Alcohol*

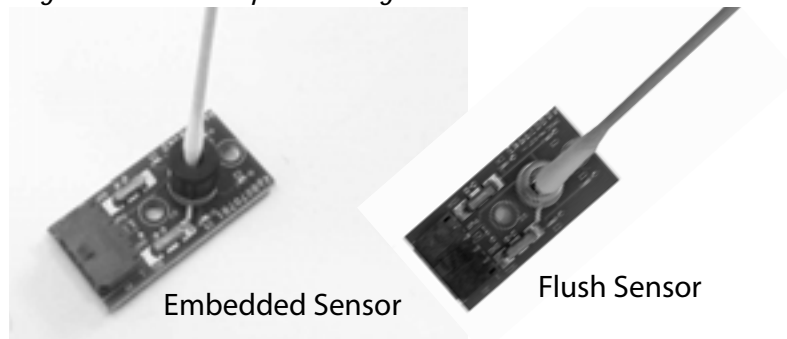


5. Swab method for cleaning sensor:

- For embedded sensors, the sensor is located inside the black tube. Insert the swab inside the black tube and gently clean the IR temperature sensor with the wet end of the cotton swab as depicted in (Figure 92).
- For flush sensors, gently clean the entire IR temperature sensor surface with the wet end of the cotton swab as depicted in (Figure 92).

*Figure 92*

*Magnified View of Proper Cleaning with Cotton Swab*

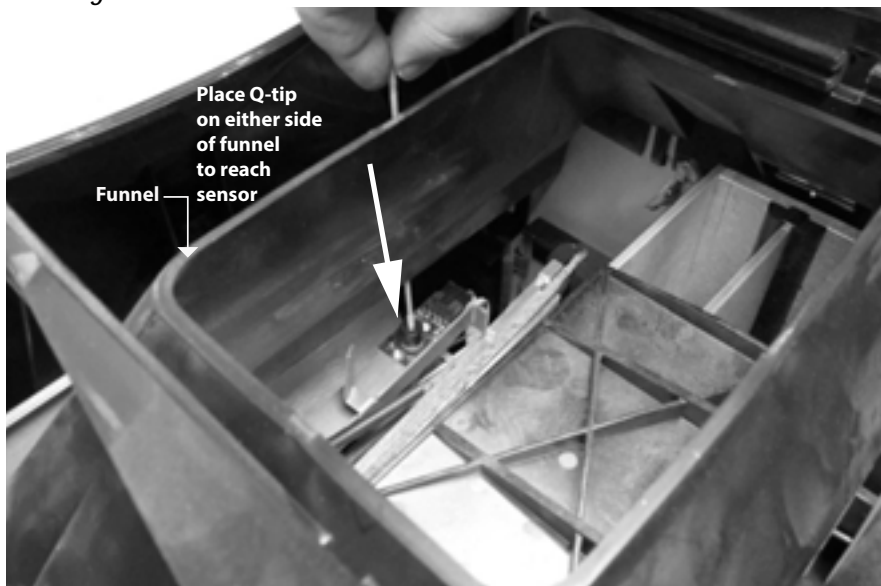




The IR temperature sensor can be cleaned with the Q-tip by placing the Q-tip through the funnel or on the outside of the funnel as depicted in (Figure 93).

*Figure 93*

*Cleaning the Sensor with Cotton Swab*



6. Allow the temperature sensor to dry for 90 seconds then gently clean with the dry end of the cotton swab.
7. Visually inspect the temperature sensor as well as all other areas cleaned to ensure the instrument is free from debris. If there is any question about the cleanliness of the instrument, it should be returned to a dealer or authorized service center.
8. If cleaning is acceptable, return instrument to upright position and replace the drawer.
9. Reconnect power cable and accessory cords.
10. Power on instrument.

**IMPORTANT:** The foregoing recommendations are provided as a guideline to maintain a robust and quality operating GAC 2500. It should not be interpreted as an exhaustive maintenance program. Dust and debris may periodically accumulate in areas not specified in this manual. The owner is responsible for ensuring overall equipment cleanliness. If any questions arise regarding the maintenance or performance of the instrument, contact your dealer or local authorized service center.





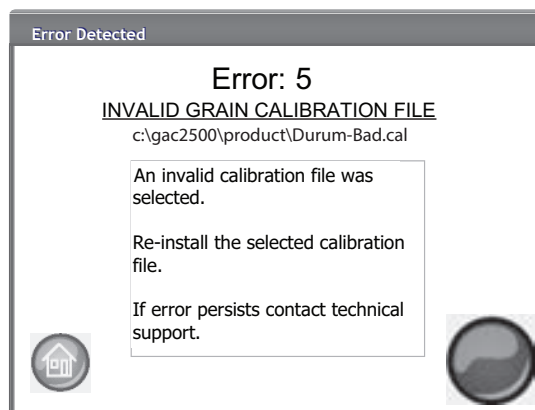
## TROUBLESHOOTING

If the system locks, press and hold the **On/Off** button on the front of machine until system turns off or unplug instrument power. Wait a few seconds and then power on.

The GAC<sup>®</sup> 2500 contains a microprocessor to control grain sample measurements and self-checks that determine the integrity of the internal electronics. If any limit is exceeded or malfunctions occur an error code displays with a recommended resolution.

*Figure 94*

*Error Screen Example*



## ERROR MESSAGES

Error messages display when an abnormal event occurs. An error can be acknowledged by pressing the **Initiate** button. The table provides an overview of error codes with potential causes and corrective actions. For any failure that persists, contact DICKEY-john Europe at +33 141 19 21 80 for service or DICKEY-john US Technical Support at 1-217-438-3371.



# OPERATOR'S MANUAL

---



# OPERATOR'S MANUAL



ERROR CODE	ERROR	PROBABLE CAUSE	CORRECTIVE ACTION
1	Empty Cell Measurement Out of Spec	Moisture or dirt buildup in cell.	Dump grain and verify cell is clean and free of grain in and surrounding the cell.
2	Empty Cell Weight Out of Spec	Empty cell measurement is out of tolerance	Dump grain and verify cell is clean and free of grain in and surrounding the cell.
3	No Products Installed	No product calibrations were found on the machine.	Install product calibration files.
4	Fill Motor Jammed	The motor has stalled while loading grain from a possible obstruction.	Clear blockage from cell.
5	Invalid Grain Calibration File	An invalid calibration file was selected.	Re-install the selected calibration file.
6	Moisture Too High	Measured product is above the moisture upper limit of the calibration.	Verify sample filled the cell.
7	Moisture Too Low	Measured product is below the moisture lower limit of the calibration.	Verify sample filled the cell.
8	Instrument Low Temp Limit Exceeded	Instrument temperature is less than the allowed limit of 0 degrees C.	Move unit to a warmer environment or allow to warm up.
9	Grain High Temp Limit Exceeded	Grain temperature has exceeded the unit specification to analyze grain.	Allow grain to cool and then re-analyze.
10	Grain Low Temp Limit Exceeded	Grain temperature has exceeded the unit specification to analyze grain.	Allow grain to warm and then re-analyze.
11	Sample Weight Too High	Test weight is greater than the range specified for the calibration selected.	Use a more representative sample and re-analyze grain. Verify correct grain calibration is selected.
12	Sample Weight Too Low	Test weight is lower than the range specified for the calibration selected.	Use a more representative sample and re-analyze grain. Verify correct grain calibration is selected.
13	No Communication	An internal communication failure has occurred and communication has been lost.	Power unit off and turn back on to reset.
14	Instrument High Temp Limit Exceeded	Instrument temperature is higher than the allowed limit of 45 degrees C.	Check unit ventilation or move to a cooler environment.
15	Unit to Grain Differential	The difference between grain temperature and machine temperature has exceeded the unit specification to analyze grain.	Allow grain and machine temperature to equalize and then re-analyze.
16	Internal Power Supply Out of Spec	Unit internal voltage is out of specification.	Service is required. Contact DICKEY-john Europe at +33 141 19 21 80 for service or DICKEY-john US Technical Support at 1-217-438-3371.
17	Unable to Predict Moisture	A corrupt instrument calibration file or other unexpected error.	Dump sample and re-analyze.
19	Instrument Needs Updated	Firmware in the instrument is out of date for this application.	Update device with new firmware.
21	File I/O Error	An unexpected file i/o error has occurred.	An obstruction has occurred in the cell. Blockage must be cleared before testing can resume.
23	Invalid GAC 2500 Model Number	The instrument does not support software above 5.0.	Return instrument to DICKEY-john for service. Contact DICKEY-john Europe at +33 141 19 21 80 for service or DICKEY-john US Technical Support at 1-217-438-3371.
24	No Locale	A region name is not present in imported Region.ini file.	Return instrument to DICKEY-john for service. Contact DICKEY-john Europe at +33 141 19 21 80 for service or DICKEY-john US Technical Support at 1-217-438-3371.
25	Could not Create Default Locale	An error has occurred while attempting to create a default locale.	Return instrument to DICKEY-john for service. Contact DICKEY-john Europe at +33 141 19 21 80 for service or DICKEY-john US Technical Support at 1-217-438-3371.
26	SD Card Missing	The SD card has been removed or is corrupt and unable to load products for calibration.	1. Insert an SD card. 2. Verify existing SD card is good. 3. Contact DICKEY-john Europe at +33 141 19 21 80 for service or DICKEY-john US Technical Support at 1-217-438-3371.
50	Weight Measurement Device Error	An error has occurred with the load cell.	Power unit off and turn back on to reset. Service unit if failure continues.

# OPERATOR'S MANUAL



ERROR CODE	ERROR	PROBABLE CAUSE	CORRECTIVE ACTION
51	Invalid Password	A service function with an invalid password was attempted.	If service is required, contact DICKEY-john Europe at +33 141 19 21 80 for service or DICKEY-john US Technical Support at 1-217-438-3371 for assistance on how to obtain the password and proper service procedure.
52	Date/Time Incorrect	The programmed machine date is less than expected.	Program the instrument date and time. If problem persists, then the battery backup for the internal clock may need to be replaced. Contact DICKEY-john Europe at +33 141 19 21 80 for service or DICKEY-john US Technical Support at 1-217-438-3371.
53	Cold Sample Moisture Too High	The sample is too high in moisture to accurately read at its current temperature.	Warm the sample above the low temperature threshold specified in the product calibration file and rerun the measurement.
55	Dump Motor Timeout	The dump mechanism does not appear to be closing.	Check that the dump motor optical sensor is clean and there is no interference in the dump mechanism. Press the Green button to retry. If error persists, contact DICKEY-john Europe at +33 141 19 21 80 for service or DICKEY-john US Technical Support at 1-217-438-3371.
100	Unexpected Application Crash	The application has encountered an unexpected error.	Press the Initiate (green) button or cycle power to reboot the instrument. If problem persists, contact DICKEY-john Europe at +33 141 19 21 80 for service or DICKEY-john US Technical Support at 1-217-438-3371.

*Dealers have the responsibility of calling to the attention of their customers the following warranty prior to acceptance of an order from their customer for any DICKEY-john product.*

## **DICKEY-john® WARRANTY**

DICKEY-john warrants to the original purchaser for use that, if any part of the product proves to be defective in material or workmanship within one year from date of original installation, and is returned to DICKEY-john within 30 days after such defect is discovered, DICKEY-john will (at our option) either replace or repair said part. This warranty does not apply to damage resulting from misuse, neglect, accident, or improper installation or maintenance; any expenses or liability for repairs made by outside parties without DICKEY-john's written consent; damage to any associated equipment; or lost profits or special damages. Said part will not be considered defective if it substantially fulfills the performance expectations. THE FOREGOING WARRANTY IS EXCLUSIVE AND IN LIEU OF ALL OTHER WARRANTIES OF MERCHANTABILITY, FITNESS FOR PURPOSE, AND OF ANY OTHER TYPE, WHETHER EXPRESS OR IMPLIED. DICKEY-john neither assumes nor authorizes anyone to assume for it any other obligation or liability in connection with said part and will not be liable for consequential damages. Purchaser accepts these terms and warranty limitations unless the product is returned within fifteen days for full refund of purchase price.

**For DICKEY-john Service Department, call  
1-800-637-3302 in either the U.S.A. or Canada**



**Headquarters:**

5200 Dickey-john Road, Auburn, IL USA 62615  
TEL: 217 438 3371, FAX: 217 438 6012, WEB: [www.dickey-john.com](http://www.dickey-john.com)

**Europe:**

DICKEY-john Europe S.A.S, 165, boulevard de Valmy, 92706 – Colombes – France  
TEL: 33 (0) 1 41 19 21 80, FAX: 33 (0) 1 47 86 00 07 WEB: [www.dickey-john.com](http://www.dickey-john.com)

# GAC<sup>®</sup> 2500 GRAIN ANALYSIS COMPUTER

MODEL GAC 2500 (INTL/C)

---



## **DICKEY-john Sales**

800-637-2952

[agsales@dickey-john.com](mailto:agsales@dickey-john.com)

## **DICKEY-john Technical Support**

800-637-3302

[service@dickey-john.com](mailto:service@dickey-john.com)

## **Europe Sales and Technical Support**

+33 1 41 19 21 80

[europe@dickey-john.com](mailto:europe@dickey-john.com)