



# GAC<sup>®</sup> 2100 GRAIN ANALYSIS COMPUTER

MODELS GAC 2100 BLUE, GAC 2100 AGRI,  
GAC 2100 GRAY



# OPERATOR'S MANUAL

---



<b>Safety Notices</b> .....	<b>1</b>
Disclaimer .....	1
<b>Introduction</b> .....	<b>3</b>
Accessories .....	3
Features .....	4
Specifications .....	4
Access Codes .....	5
External Communication Connections .....	5
Printer .....	6
<b>Unpacking the Instrument</b> .....	<b>7</b>
Disengage Shipping Brace .....	7
Instrument Placement .....	8
<b>Installation</b> .....	<b>11</b>
Connecting AC Power .....	11
Sample Drawer Bypass .....	12
<b>Navigation</b> .....	<b>13</b>
Display Screen .....	13
Adjust Screen Contrast .....	13
Keyboard Layout .....	13
Alarm .....	14
Key Functions .....	14
Menu Screens .....	15
<b>Startup Procedure</b> .....	<b>17</b>
Test Samples (Quick Start) .....	18
<b>Measure Moisture</b> .....	<b>19</b>
Basic Method .....	20
Grain Sample ID Numbers .....	22
Enter Numbers and Alpha Characters .....	22
ID Options .....	23
Factors (Labels) .....	23
Next Page View .....	24
<b>Grain Selection</b> .....	<b>25</b>
Select Grain Menu .....	25
Quick Keys .....	26
<b>Calibrate Procedures</b> .....	<b>27</b>
View Calibration Data (1 Key) .....	27
Enter/Change Calibration Values (2 Key) .....	28
Print Calibration Grain List (3 Key) .....	31
Obtain Basic Calibration Data (4 Key) .....	32
Print Audit Memory Data (5 Key) .....	34
Memory Full .....	36



<b>Instrument Setup</b> .....	<b>39</b>
Clear Cycle Counter (1 Key) .....	39
ID Options (2 Key) .....	40
Configure Output Options (3 Key) .....	41
Change The Access Code (4 Key) .....	44
Change Date, Time and Date Format (5 Key) .....	46
Change Labels (6 Key) .....	48
Set Communications Port Parameters (7 Key) .....	51
Non-Active (5 Key from Communications Menu) .....	58
Service Menu (8 Key) .....	58
Quick Keys Menu .....	58
Test Weight Bias Adjustment .....	59
Test Weight Slope Adjustment .....	61
Moisture Bias Adjustment .....	62
Moisture Slope Adjustment .....	64
<b>Test Unit Performance</b> .....	<b>67</b>
Non-Active Keys .....	67
View COM1 Port (2 Key) .....	67
View COM2 Transmit Port (3 Key) .....	68
View Display Characters (5 Key) .....	69
View Diagnostic Mode (6 Key) .....	70
Test Network Mode (7 Key) .....	72
View/Print Parameters (8 Key) .....	73
<b>Operator Maintenance</b> .....	<b>77</b>
Cell Cleaning - Daily .....	77
Fuse Replacement .....	77
<b>Error Codes</b> .....	<b>78</b>
<b>Appendix A: Communication Ports</b> .....	<b>79</b>
COM1 Port options .....	79
COM1 Pin Assignment Details .....	79
COM2 Pin Assignment Details .....	80
<b>Warranty</b> .....	<b>83</b>



## SAFETY NOTICES

Safety notices are one of the primary ways to call attention to potential hazards.

**This Safety Alert Symbol identifies important safety messages in this manual. When you see this symbol, carefully read the message that follows. Be alert to the possibility of personal injury or death.**

### **WARNING**

---

Use of the word **WARNING** indicates a potentially hazardous situation which, if not avoided, could result in death or serious injury.

---

### **CAUTION**

---

Use of the word **CAUTION** with the Safety Alert Symbol indicates a potentially hazardous situation which, if not avoided, may result in minor or moderate injury.

---

### **CAUTION**

---

Use of the word **CAUTION** without the safety alert symbol indicates a potentially hazardous situation which, if not avoided, may result in equipment damage.

---

## DISCLAIMER

DICKEY-john reserves the right to make engineering refinements or procedural changes that may not be reflected in this manual. Material included in this manual is for informational purposes and is subject to change without notice.



## LIABILITY

DICKEY-john designed the GAC<sup>®</sup> 2100 Grain Analysis Computer to measure oilseed and grain moisture content. We rigorously test and calibrate each instrument before it leaves the factory. Use of the instrument in the field, however, is subject to environmental and operating conditions beyond our control. DICKEY-john disclaims all liability for damages resulting from environmental and operating conditions beyond our control and for any damages that might follow incorrect results due to those environmental or operational conditions. **IN NO EVENT SHALL DICKEY-JOHN OR ANY OF ITS AFFILIATES, OFFICERS, DIRECTORS, SUCCESSORS OR ASSIGNS BE LIABLE FOR ANY DAMAGES WHATSOEVER, INCLUDING SPECIAL, INDIRECT, CONSEQUENTIAL OR INCIDENTAL DAMAGES OR DAMAGES FOR LOSS OF PROFITS, REVENUE, USE, OR DATA AS A RESULT OF CLAIMS, REGARDLESS OF THEORY BROUGHT, ARISING OUT OF OR CONNECTED WITH ANY USE OF RELIANCE THE GAC<sup>®</sup> 2100 GRAIN ANALYSIS COMPUTER.**

Therefore, we expect the operator to take responsibility to assure that the results of the testing are as accurate as possible by following approved maintenance procedures on a regular basis, by cleaning the instrument and its sensors on a regular and as-needed basis depending on the amount of dust, dirt, and debris encountered in the instrument's use, by monitoring performance using daily check samples, and by adhering to the check procedures set forth in the manual. As with any kind of sophisticated equipment, optimal results depend in part on proper cleaning and maintenance.

Repair and Service of the GAC 2100 instrument should only be performed by authorized service personnel.

For questions concerning these issues, refer to the product warranty, or call your DICKEY-john representative.



## INTRODUCTION

The DICKEY-john Grain Analysis Computer GAC<sup>®</sup> 2100 quickly tests grain samples for moisture content and other profile information. The unit loads a sample, weighs and checks temperature, runs the test, displays the results, and unloads the sample.

*NOTE: Three models are addressed in this manual; and include the GAC<sup>®</sup> 2100 Blue (all variants), GAC<sup>®</sup> 2100 AGRI (all variants), and GAC<sup>®</sup> 2100 Gray (all variants). Differences in models are indicated.*

Test results calculate automatically to display the moisture content. If enabled, the temperature and approximate test weight (density) of the grain sample will display. The product name, grain calibration date, and sample ID numbers display for identification purposes.

An additional screen of information includes readings for conductance (D1), capacitance (D2), weight (D3), and temperature (D4) values along with the current date and time.

*Figure 1*

*GAC<sup>®</sup> 2100 Instrument*



## ACCESSORIES

- Drawer p/n 464220420BS1
- Null Modem Adapter DB9 Null Modem Adapter 9 pin p/n 220490001 (computer to unit connection)
- Communication software package to upload calibrations to unit via a computer (available via email by contacting a DICKEY-john representative).



## FEATURES

GAC 2100 features include:

- Memory storage for grain calibrations
  - 64 grain calibrations (GAC 2100 Blue)
  - 8 grain calibrations (GAC 2100 AGRI)
  - 16 grain calibrations (GAC 2100 Gray)
- Keyboard entry or computer accessibility for updating grain calibrations as revisions become necessary.
- Alpha/numeric sample identification numbers with automatic sequential numbering for record keeping purposes.
- Automatic ranging by switching to predetermined calibrations when moisture is above or below normal limits.
- Two RS-232 output ports (DCE and DTE) available for printer and external computer/modem control.
- Capability to interface with a personal computer either directly or through a modem (Blue model).
- Self-check mode to ensure proper continual operation.
- Error messages for out-of-limits moisture, grain weight, or grain temperatures.
- Help screens to address operator issues.
- Quick keys (Blue model)
- Test weight slope and bias adjustment all grains
- Moisture slope and bias adjustment all grains

## SPECIFICATIONS

- **Supply Voltage and Frequency Limits:**
  - 110/220V, 50/60 Hz, 30/35VA
- **Operating Temperature Range:**
  - 2° C (35.6° F) to 45° C (113° F) (Blue model)
  - 5° C (41° F) to 45° C (113° F) (AGRI and Gray models)
  - If the instrument exceeds temperature ranges, an error displays.
- **Grain Temperature Range:**
  - 0° C (32° F) to 45° C (113° F) (Blue model)
  - 0° C (32° F) to 50° C (122° F) (AGRI and Gray models)
  - If the grain temperature range is exceeded, an error message displays.
- **Unit Temperature and Grain Temperature Difference Limit:** The maximum allowable temperature differential between empty cell and grain under test is 20° C (36° F). If exceeded, an error message displays.
- **Classes/Types of Grain or Seed:** Refer to the latest Calibration Bulletin.
- **Weight:** 11.8 kg (26 lbs) – **Shipping Weight:** 15.0 kg (33 lbs)



## ACCESS CODES

An access code is necessary to gain access to certain screens. Whenever the code is required, a screen appears stating ENTER ACCESS CODE. The factory preset access code is set to "0". To change the access code for security reasons, refer to "Changing the Access Code" in "Instrument Setup" section.

## EXTERNAL COMMUNICATION CONNECTIONS

### GAC 2100 Blue

The GAC 2100 Blue is capable of communicating with a computer via a direct connection using a null modem cable.

### GAC 2100 AGRI and Gray

The GAC<sup>®</sup> 2100 AGRI and Gray models can output to a personal computer (PC) using the COM1 or COM2 ports. The two communication ports are located on the rear of the unit and are identified as Printer Output Port (COM1) and Computer Output Port (COM2). Each must be properly configured to communicate with external devices. Port configuration is described in the Instrument Setup section.

**When using the COM2 port, a null cable or null adapter is required. A null adapter is available from DICKY-john.**

*Figure 2*

*Communication Ports*

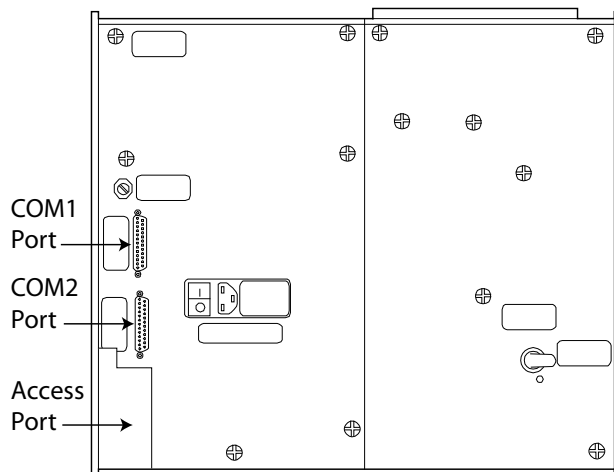





## PRINTER

An optional printer connected to the instrument can print test data results. The printout can include:

- Facility name and address
- Current date and time
- Sample ID number
- Product name
- Grain calibration date
- Percent moisture
- Test Weight
- Grain temperature
- Unit serial number
- D1 through D4 values



**Print Key**

Data can automatically print at the end of each measurement cycle or manually initiated by pressing the **Print** key.



## UNPACKING THE INSTRUMENT

### DISENGAGE SHIPPING BRACE

#### **CAUTION**

The shipping brace must be moved to the operate position before applying power. Since the grain test cell cycles through an unload sequence during power up, damage may occur with the shipping brace in the transport position.

The GAC 2100 is shipped with the grain test cell supported by an internal shipping/transport brace. This brace supports the test cell whenever the unit is transported. The position of the brace is controlled by a handle located on the rear panel behind the grain test cell (Figure 5). A small spool is placed over the handle to prevent possible bumping and release of the handle during shipment.

#### To Disengage Shipping Brace:

1. Remove spool and store with shipping materials.
2. Push the handle in to unlock position and rotate counterclockwise to the locked operate position as indicated on the back panel.
  - The movement of the brace is viewable through the front window of the unit.

Figure 3

Disengaging Shipping Brace

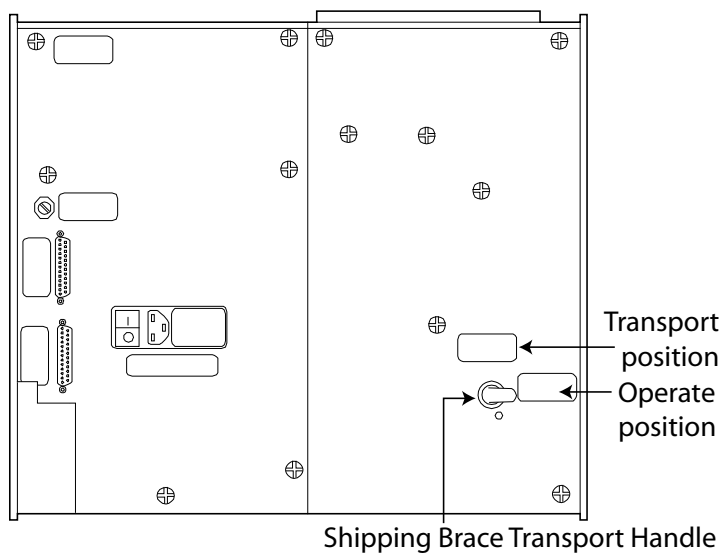



## ⚠ CAUTION

Rotate the brace back into supporting position before moving or shipping the unit. If the cell is not adequately supported operating performance may be adversely affected due to cell bouncing. Some effort is required to move the brace back into position. It may be helpful to reach inside the drawer front and lift up on the cell while attempting to lock the brace into the transport position. Place the spool over the handle to prevent the accidental release of the shipping brace.

## INSTRUMENT PLACEMENT

Choose a clean environment that is protected from rapid changes in ambient temperature. Avoid a hazardous (classified) location as defined in Article 500 of the NFPA Handbook of the National Electrical Code.

## ⚠ WARNING

Instrument should be placed in a dry environment/area free to standing water or dampness to avoid electrical shock.

Figure 4

GAC 2100 Dimensions

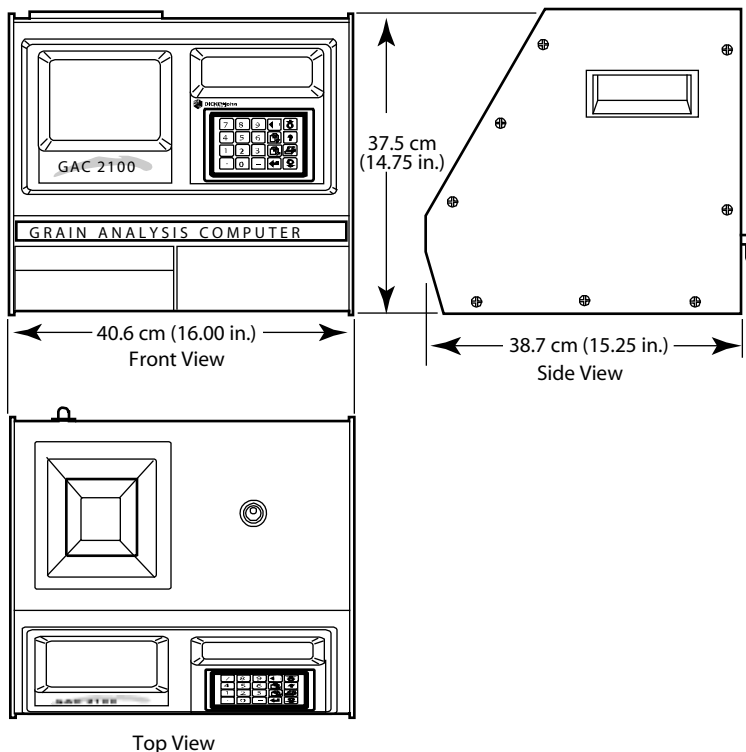



## To Level the Instrument:

1. Use the self-contained level on the panel top to position the GAC 2100 on a flat level or nearly level surface.
2. Adjust the four rubber foot pads to level and stabilize the unit (Figure 5). To adjust the foot pad height, unlock the upper nut from the bottom panel of the selected foot pad and adjust height as required.
  - All four leveling foot pads should be set to the lowest level possible with one pad fully seated against the bottom panel. This ensures minimum height above the counter top.
  - When moving the instrument to a different location, re-leveling may be required.
3. After adjusting, use a Phillips screwdriver in the center of the foot pad to hold the screw from turning and tighten the upper nut against the bottom panel of the unit.
4. Ensure the lower nut remains tight against the foot pad.

*Figure 5*

### *Leveling With Rubber Foot Pads*

1. Use wrench to loosen the upper nut and then adjust height.
2. Ensure bottom nut is locked down against rubber foot pad.
3. Use a Phillips screwdriver in center of pad to change height and to hold the screw from turning while tightening nuts.
4. After adjustment, retighten nut up against bottom panel.

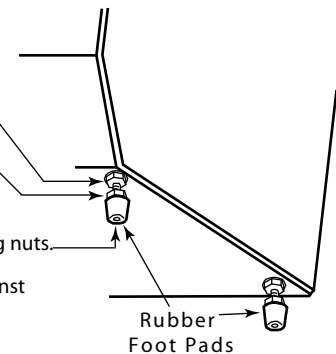

# OPERATOR'S MANUAL

---





## INSTALLATION

Before shipping, the GAC 2100 is inspected and tested for mechanical and electrical defects. After unpacking, visually inspect for possible damage that may have occurred during transit. Save all packing materials until the inspection is complete. If damage is found, immediately file a claim with the carrier and notify your DICKEY-john representative.

### CONNECTING AC POWER

1. Verify that the ON/OFF (I/O) switch is in the OFF (O) position and that the shipping brace is in the OPERATE position.
2. Plug the line cord into the connector on the rear panel next to the ON/OFF switch.
3. Plug the male end into an appropriate 3-wire (grounded) outlet.

### **⚠ WARNING**

**The grounding pin on the line cord connects directly to the GAC 2100 frame. When using an adapter with a grounding wire ensure the grounding wire is connected properly to a good earth ground to prevent a shock hazard.**

**Do not use detachable MAINS supply cord with inadequate rating.**

*Figure 6*  
*Connecting Power*

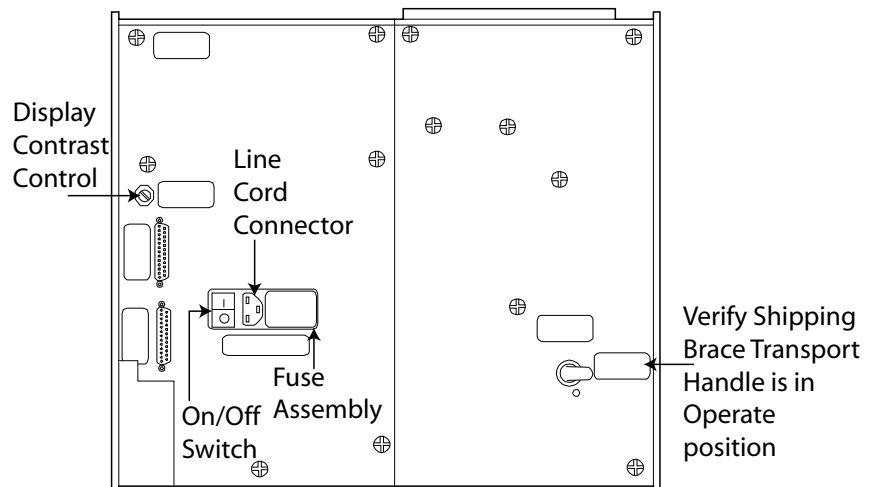



## SAMPLE DRAWER BYPASS

Normal use of the sample drawer can be bypassed by removing the drawer bottom and cutting a hole into the work counter to allow the tested grain samples to fall through to a larger container below. The size of the hole must be at least equal to the drawer dimension and located directly beneath the grain sample drawer.

### To Remove Sample Drawer Bottom:

1. To remove the bottom of the grain sample drawer, carefully lift the two plastic tabs at the front of the drawer ([Figure 7](#)).
2. Using a small screwdriver, gently pry up on each tab and slide the bottom panel out the rear of the drawer.

### CAUTION

Use care when prying on tabs to prevent breakage.

---

3. When finished, slide the grain drawer back into position. This prevents grain from spilling onto the work surface in front of the unit.
  - If replacing the drawer bottom later, slide the bottom toward the drawer front until it latches under the two plastic tabs.

*Figure 7*

*Removing Drawer Bottom*

---

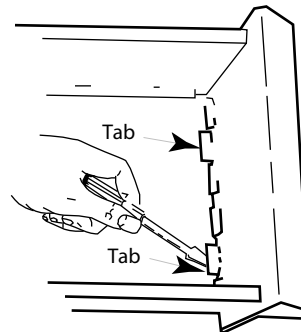



## NAVIGATION

### DISPLAY SCREEN

The display screen is a graphics Liquid Crystal Display (LCD) and is backlighted for low light level viewing.

### ADJUST SCREEN CONTRAST

The Display Contrast Control is on the rear panel (Figure 6) immediately above the COM1 and COM2 ports. The contrast control changes the contrast between the displayed characters and the background. Adjust the control as necessary for a comfortable contrast level in varying light conditions.

### KEYBOARD LAYOUT

All operator controls, except the Power ON/OFF switch and Contrast control, are located on the front panel. These two are on the rear panel.

The sealed membrane keyboard contains 20 pressure-sensitive keys requiring light finger pressure to actuate each key. Valid key closures result in short tone bursts while invalid keystrokes generate longer tone bursts. The function of each key or key group is defined as follows and illustrated in (Figure 8).

Numbers (0 through 9), Decimal point (.) and Minus (-) keys

All numeric keys perform dual functions, making menu selections, and entering numeric values. The four numeric keys with small arrows have the additional function of screen navigation. When making a numeric entry, a prompt on the display identifies the value entered and a cursor shows the destination of each entry. The minus (-) sign is accepted at any point in the entry and displays at the front of the entered string.

*Figure 8*

*Keyboard Layout*

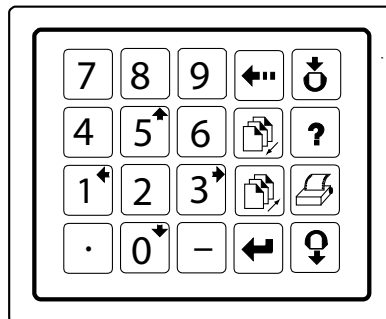

Keys 0, 1, 3, and 5 also function as arrow keys to navigate to certain screens.

Each entry immediately displays as the cursor moves to the right in preparation for the next entry. Only the first entry of the decimal point is acknowledged.





## ALARM

An audible alarm is enabled for 0.5 seconds at the end of each grain analysis or for an error condition. A shorter beep of 0.1 seconds sounds for each valid key stroke.

## KEY FUNCTIONS



### BACKSPACE KEY

Moves the cursor to the left to delete the last keystroke or to clear an entire entry field.



### NEXT PAGE KEY

Advances to the next page when the <more> prompt appears in the lower right corner of the display. The **Next Page** key sequences the display forward to additional pages of information. The total page number and page count appear in the lower left corner of screen (i.e. PAGE 2 OF 8).

*Figure 9*

*Typical Screen Indicating More Pages*

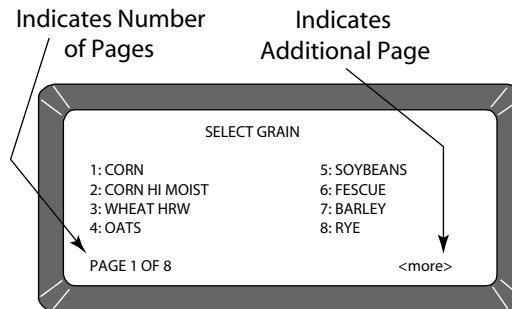

### PREVIOUS PAGE KEY

Sequences backward through previously displayed pages. Neither the **Previous Page** or **Next Page** keys roll-over the pages to the beginning or end.



### ENTER KEY

Accepts the character string after an entry is complete.



### LOAD KEY

Initiates a grain cell loading sequence to begin a test cycle.



### HELP KEY

Provides context-sensitive help screens on the display. If the <more> message appears at the lower right of the screen, additional pages are accessible with the **Next Page** key. To use the HELP INDEX when in a **Help** screen, select the 0 key and select the desired topic. To resume normal operation, select the **Help** key a second time.

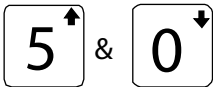
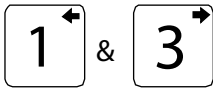

## PRINT KEY

Initiates a printout of current information on the screen (e.g., grain moisture analysis, calibrations data, etc.). If the automatic printout option is selected, the **Print** key initiates duplicate copies. Help information does not print. COM SETUP options allows the **Print** key to transmit to either the printer port or the communications/modem port. For example, the system may be configured to automatically print results through the printer port while the **Print** key transfers results to the computer port.

## UNLOAD KEY

Dumps the contents from the test cell after a grain test.

## LEFT AND RIGHT KEYS

Moves the cursor horizontally during alpha entries and certain functions during the SETUP mode.

## UP AND DOWN KEYS

Moves the cursor vertically during alpha entries and certain functions in the SETUP mode.

## MENU SCREENS

The **Main** menu displays once the start-up checks are successfully completed. The **Main** menu is the “home” screen that all other screens are accessed. The **Main** menu displays five major selections or categories.

A number appears next to each **Main** menu selection. Select the desired number to access the appropriate menu. Refer to (Figure 11) for a general configuration of the Menu Tree layout.

*Figure 10*

*Main Menu Selections*

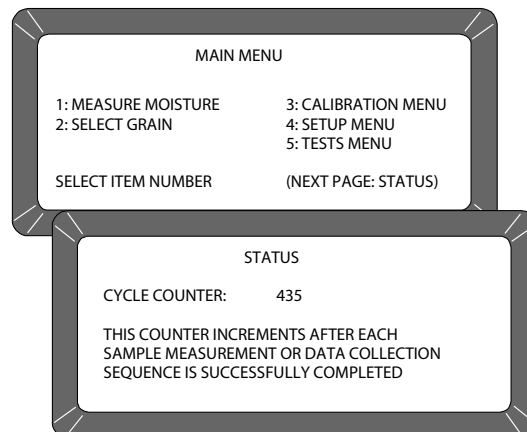

# OPERATOR'S MANUAL



Figure 11  
Menu Tree

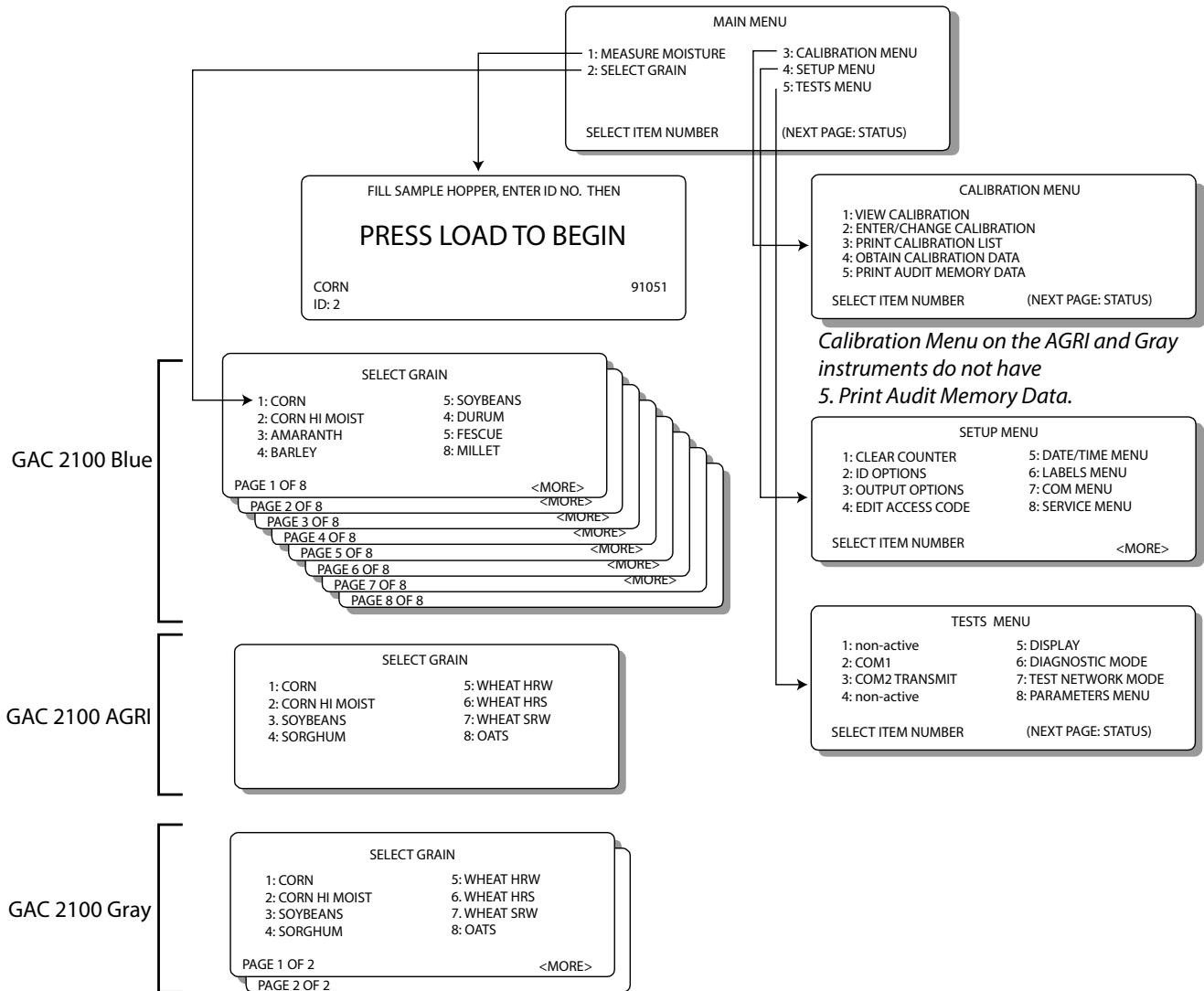



## STARTUP PROCEDURE

Each time the GAC 2100 is powered on, the instrument performs a series of self checks to determine the status of the following:

- Load/strike-off mechanism
- Unload function
- Empty test cell weight
- Conductance/capacitance measurement circuitry

Self-checks begin when the hopper doors open, the strike-off arm swings across the cell and back again, and the cell dumps. When the cycle ends (about 15 seconds), the **Main Menu** displays.

### **CAUTION**

**Before starting the following procedures, ensure the ON/OFF (I/O) switch is in the OFF (O) position and that the shipping brace is in the OPERATE position. These are both located on the rear of the unit.**

1. Turn the power switch ON. Initially, a language screen appears showing eight choices (Figure 12). Two English selections are available: English US and English.
  - English US invokes parameters to display test weight for NTEP-certified calibrations used in the United States and allows the option of displaying test weight on the Analysis screen.
  - English is for non-NTEP users that do not require test weight parameters.

*Figure 12*

*Start Up Screens*

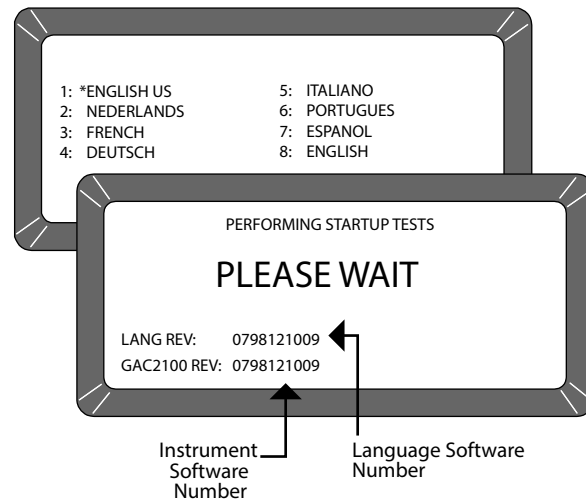



2. Select a language by pressing the respective number on the keypad next to the desired language.
  - This screen only remains available for approximately 8 seconds.
  - Once selected, an asterisk appears and remains in front of the selection until changed again during another startup cycle.
3. Wait for the remaining portion of the cycle to finish. A second screen displays PLEASE WAIT while the unit is performing self checks. The bottom two lines of this screen display the software revision numbers (Figure 12).
4. After the **Main Menu** displays proceed with general operation.

## TEST SAMPLES (QUICK START)

Performing a grain sample analysis consists of six basic steps:

1. Select a grain for testing through keyboard entries.
2. Pour grain sample into the hopper (top of the unit) and enter a sample ID number (optional).
3. Press the **Load** key. The sample automatically loads (drops) the grain into the test cell and a strike-off arm levels and removes the excess.
4. Wait briefly for the test results to process. The moisture reading and grain temperature display.
5. Print a hard copy of the test results.
  - With an optional printer connected, the date and time with sample identification number and all test information prints.
  - By selecting the **Print** key, additional copies can be printed.
6. Press the **Unload** key to empty the test cell contents.
  - The test cell rotates 180° (inverts) to dump the grain into a sample drawer or into a larger container below the counter top.
  - After the cell returns to the upright position, the instrument is ready for the next test sample.



## MEASURE MOISTURE

The Main Menu appears immediately after all startup checks have successfully concluded. The Main Menu displays five major selections for categories.

### To Measure Moisture:

1. Choose MEASURE MOISTURE (1 Key) from the **Main** menu to display the **Select Grain** menu.

*Figure 13*

### *Moisture Testing Preparation*

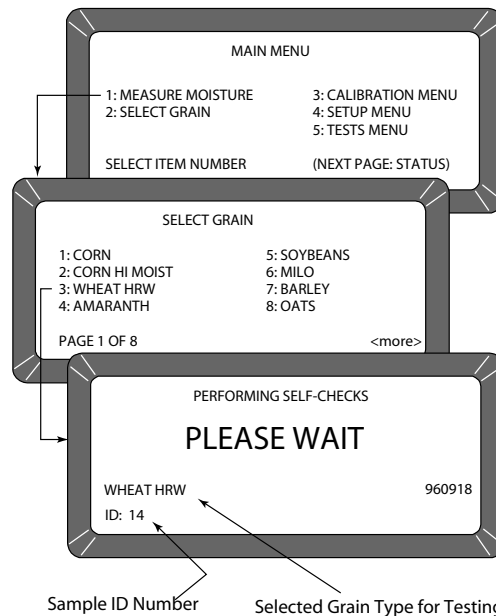

Next Page Key



Previous Page Key

2. Locate the grain type for testing and select the corresponding number to the left.
  - After selecting a grain, the unit cycles through self-check tests to ensure the program memory and calibrations are valid.
  - Subsequent moisture measurements default to the previously selected grain.
  - For models with multiple pages on grains, select the **Next Page** key.
3. If a different grain is desired, press the **Previous Page** key to return to the **Main** menu.
4. Select the option SELECT GRAIN (2 key) and choose a new grain (refer to GRAIN SELECTION for additional information).
5. Enter a sample ID number. This number identifies the sample tested on the paper printout. If the ENTER REQUIRED FOR ID is turned ON (refer to CHOOSING ID OPTIONS in the ESTABLISHING PARAMETERS section), the **Enter Sample ID** screen displays and an ID number is required. Other ID numbering options bypass this screen. Details on how to use ID numbers are described later in this section.



6. Use the **Down Arrow** key (0 key) to place the cursor next to the ID and enter any number.
7. Press the **Enter** key.

*Figure 14*

*Screen Sequence Using Enter Required For ID*

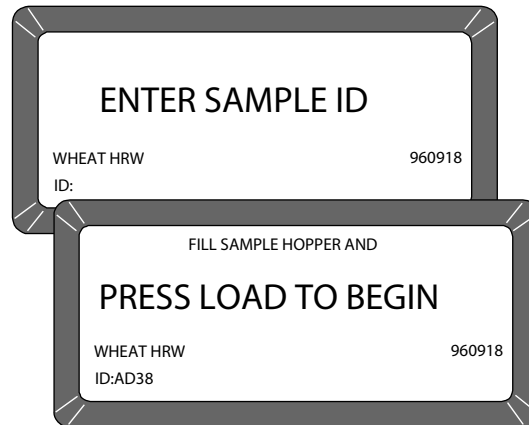

## BASIC METHOD

After all calibration self-checks for the selected grain are complete (approximately 10 seconds), the message FILL SAMPLE HOPPER, ENTER ID NO. THEN...PRESS LOAD TO BEGIN displays (Figure 15).

### To Measure Moisture:

1. Pour grain into the sample hopper. Fill the hopper until the grain is at least 1.25 cm (1/2 inch) above the separation line between the hopper top and hopper compartment (heap grain slightly). The exact volume is unimportant, except enough grain must be present to overfill the cell (approx 0.5 liter or 2 cups). Excess grain spills over the cell top and falls into the grain drawer below.
2. If an ID number is not entered, enter a number or skip to step 3.
3. Press the **Load** key to begin the test cycle.
4. GAC 2100 Blue- If factors (a type of label) are enabled, a screen displays the message ENTER RESULTS FOR THE FOLLOWING.
  - Disregard this screen by entering a number and selecting the **Enter** key. Refer to FACTORS for additional information.
5. Press the **Load** key, the hopper doors open and drop the grain into the test cell. The cell fills and the striker arm swings across the top to remove excess grain.



**Do not insert fingers or other foreign objects into the opened hopper doors.**

6. Wait for the moisture test to complete (Figure 15). A screen displays the message MEASURING - PLEASE WAIT.



Load Key



Enter Key



Figure 15

Basic Moisture Measuring Cycle

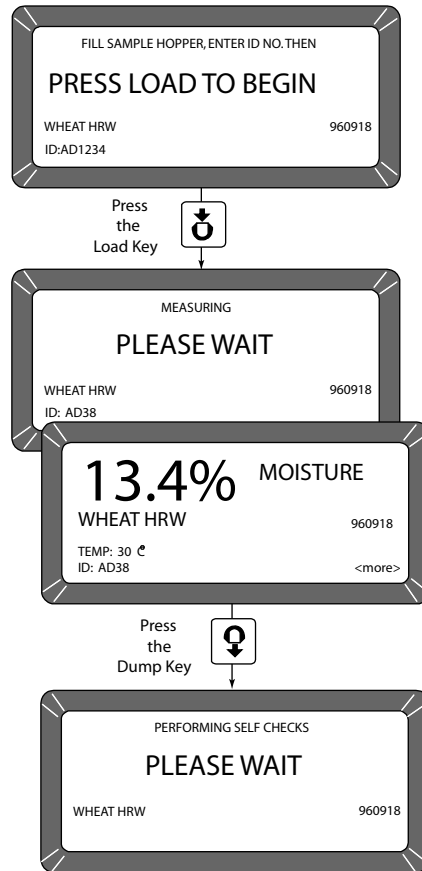

7. The grain name, moisture, sample ID and grain calibration issue date appears on the display along with the sample temperature and test weight, if enabled.
8. The option <more> displays on the lower right corner of the screen.
9. Press the **Next Page** key to view additional pages. The D1 through D4 values display along with the present date (lower left corner) and time (lower right corner).
10. Blue model-If the <more> prompt continues to display, press the **Next Page** key again.
  - This page is only available if FACTORS are used. FACTORS are a type of label that allows entry of data for additional information on the paper printout. Up to four user-defined factors (or labels) may display and print as specified on the **Setup** menu. If this screen displays, enter numbers as desired and select the **Enter** key. If no factor names are specified, the screen will not display.
11. When the measurement is complete, select the **Unload** key. The test cell will invert dumping the grain and returning to the upright position.
12. Start a new moisture measurement for the same grain type. The GAC 2100 remembers the grain type until it is changed or power is turned OFF. The **Select Grain** menu does not appear again until it is selected.



Next Page Key



Enter Key



Unload Key







Previous Page Key



Backspace Key

phrase is complete. If an error is made, select the **Backspace** key and re-enter the corrected character.

5. After completing the text string, select the **Previous Page** key. The text string becomes part of the ID field on the **Press Load To Begin** screen. Additional numbers can be inserted after the text string as before. Deleting is accomplished by entering the alpha screen again and using the **Backspace** key to delete letters.
  - GAC 2100 Blue-Using the S1 through S10 character strings is described in Instrument Setup. Character strings are predetermined phrases to insert into an alpha text line when needed (i.e. BROWN).

## ID OPTIONS

ID numbers typically identify grain samples. The numbers can be a simple number (e.g., 1, 2, 3, etc.), a combination of letters and numbers (i.e. operator's initials plus sample number) or the customer's name (i.e. BROWN). The ID field can contain up to 16 alpha numeric characters.

The ID option is selected through the **Setup** menu, ID OPTIONS (refer to Instrument Setup). ID numbers are added to each tested sample using one of three methods:

1. **Inserted Manually** - Any ID field, including none at all, are assigned to grain samples before each test. This flexibility allows the creation of individualized numbering schemes.
2. **Automatic Sequencing** - Numbers can be sequentially assigned automatically to each moisture test. For example, 1, 2, 3, etc. or specific letters (i.e. initials) can be placed in front of the numbers (i.e. JW12). Only the numbers at the end of the field change automatically.
3. **Entry Required For ID** - An ID field is required before each moisture test can proceed. This method ensures each sample is properly identified, typically for printer output. A screen displays before the moisture test requests the user to ENTER SAMPLE ID. Alpha characters can be used if desired.

## FACTORS (LABELS)

### Blue Model

Factors are predetermined labels that appear at the beginning of each moisture test similar to sample ID numbers. Up to four factors display and print as specified in the calibration. For each FACTOR specified, an entry must be made before initiating the moisture measurement. Entries (numeric only) can be up to six digits long (Figure 17). FACTORS are established on the **Setup** menu (refer to Instrument Setup).



Figure 17

Example of Factors

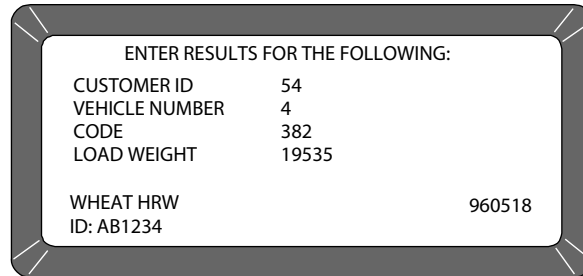

## NEXT PAGE VIEW

After the grain analysis is complete and the moisture content displays, <more> appears on the lower right corner of the screen indicating another page is available.



Next Page Key

Press the **Next Page** key to view the calculated values (D1, D2, D3 and D4) determined from the grain measurement (Figure 18). These values are relatively unimportant to the operator but are important to service personnel. A general definition of each value is as follows:

- D1** - Conductance measurement to indicate grain surface moisture.
- D2** - Capacitance measurement to indicate internal grain moisture.
- D3** - Weight measurement to indicate grain weight.
- D4** - Temperature to indicate grain temperature.

### Blue model-

Below the D calculations, the TEST WEIGHT OFFSET (as applicable) appears. This value is programmed on the **Setup** menu (refer to Instrument Setup). The current date, time, and sample ID also display.

Figure 18

Next Page Typical Calculated D-Values

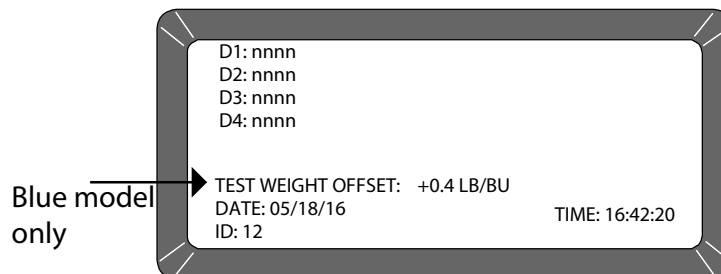



## GRAIN SELECTION

The second item on the **Main** menu is the **Select Grain** menu to select specific grain types for testing. The **Select Grain** menu automatically displays for the first moisture test each time power is applied. It may also be selected at any time to test different grain types. After the first test, the **Select Grain** menu must be selected manually.

GAC 2100 Blue-One exception is through the use of QUICK KEYS. However, these are limited to three grain choices, usually the most common grains. The use of QUICK KEYS allows a programmed grain to be selected prior to loading the grain into the test cell (refer to ANALYZING GRAIN).

## SELECT GRAIN MENU

### Grain Calibration Storage

- GAC 2100 Blue-Stores up to 64 unique grain calibrations. The first 40 are restricted and can only be changed by authorized personnel. The remaining 24 are less secure and can be changed using the access code.
- GAC 2100 AGRI-Stores up to 8 different grain calibrations.
- GAC 2100 Gray-Stores up to 16 different grain calibrations.

### To Select a Grain for Testing:

1. Choose the **Select Grain** menu from the **Main** menu by selecting the 2 key.
  - Blue and gray models - The first page of the **Select Grain** menu displays the first eight grain calibrations available. The prompts on each lower corner of the display indicate additional pages are available ([Figure 19](#)).
2. Blue and Gray models - Press the **Next Page** key to advance to the next page. The next eight grain calibrations will display. The **Next Page** key allows access to all available eight pages. When the last page displays, the <more> prompt no longer remains visible on the screen.
  - Press the **Previous Page** key to move backward. The **Previous Page** key is the counterpart of the **Next Page** key.



Next Page Key



Previous Page Key



Figure 19

Select Grain Menus

### Blue

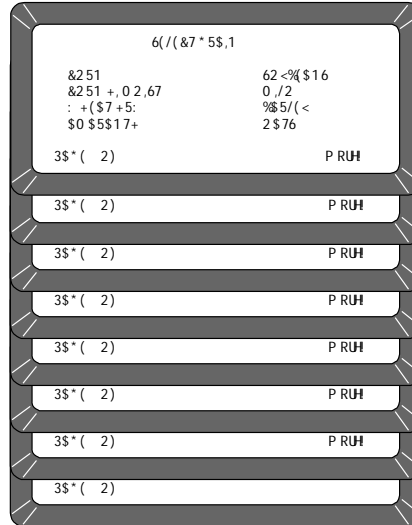

### AGRI

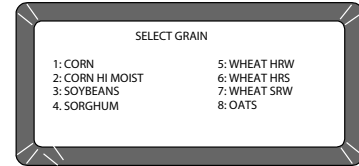

### Gray

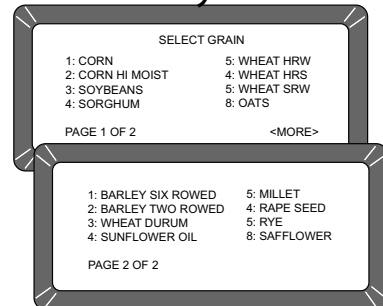

Load Key

- Press the number key corresponding to the desired grain. After selecting the grain, the GAC 2100 automatically enters the MEASURE MOISTURE mode and retains the grain selection until a new grain is selected again or the power is turned OFF.

## QUICK KEYS

### Blue Model

QUICK KEYS makes changing between frequently-used grains easier during moisture measurements by bypassing the **Select Grain** menu. Up to three frequently used grains can be programmed for keyboard keys 1, 2, and 3. The desired key (grain) changes the grain to be tested whenever the 1, 2, or 3 key is pressed on the **Press Load to Begin** screen.



## CALIBRATE PROCEDURES

The **Calibration** menu allows authorized personnel to:

- view calibration constants of selected grains
- enter new or change existing calibrations
- print the entire list of stored grain calibrations
- obtain calibration data necessary to generate new calibrations
- print audit memory data (Blue model)

Choose a function by selecting the number key corresponding to the desired function (Figure 20).

*Figure 20*

*Calibration Menu With Status Page*

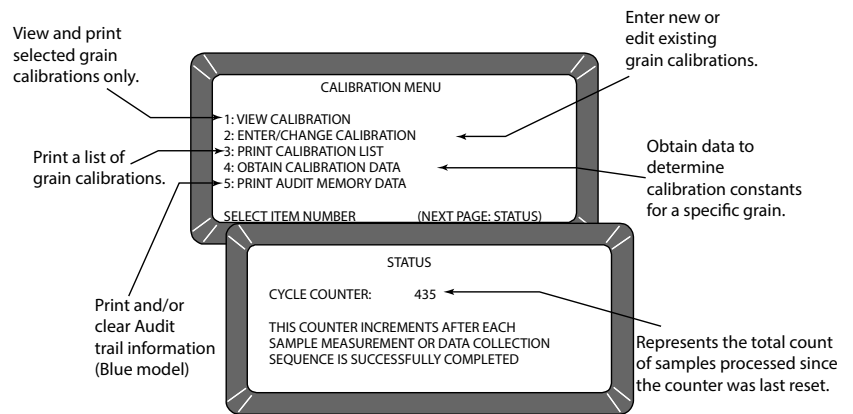

### VIEW CALIBRATION DATA (1 KEY)

The **View Calibration** menu allows for viewing and printing of a selected grain calibration (Figure 21). Editing cannot be performed in this function.

#### To View Grain Calibrations:

1. From the **Calibration** menu, choose **View Calibration** by selecting the 1 key.
2. Choose a grain calibration to view from the grain list pages and then select the corresponding number key.
  - Use the **Next Page** key to view additional pages, if applicable.
3. The **View Calibration** screen displays the grain name, moisture range, calibration issue date, and the nine calibration K values.
4. If a printer is connected, FACTORS (Blue model) are defined and AUTO RANGE is specified in the calibration, this information also prints. The lower right corner of the **View Calibration** screen indicates <more> meaning another page is available.
5. Blue model-Press the **Next Page** key to display the **Factors** screen. The **Factors** screen displays the grain name and up to four defined factors. If the grain does not have defined factors, the labels are empty. The <more> prompt also displays on this page.



Next Page Key



Print Key



Next Page Key

- Press the **Next Page** key to view the **Auto Range** screen. The **Auto Range** screen displays grain name and calibrations automatically used to extend the moisture range if the normal maximum and minimum limits are exceeded. Separate grain calibrations or grains may be referenced for each limit.

Figure 21

View Calibration Menu Showing Wheat HRW

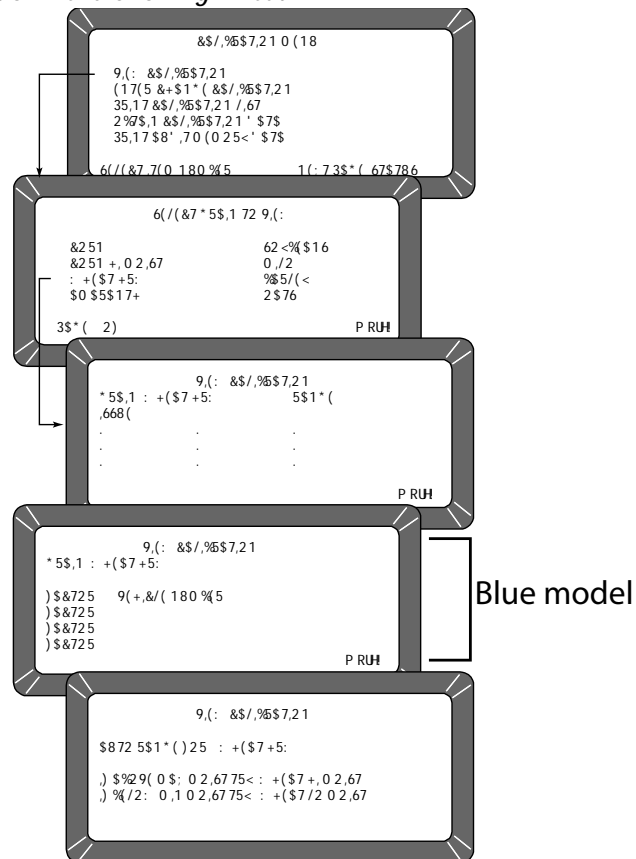

## ENTER/CHANGE CALIBRATION VALUES (2 KEY)

Blue model-This function enters or changes grain calibrations. Grains 1 through 40 are restricted to authorized personnel only. Grains 41 through 64 are considered "unofficial calibrations" and can be accessed by using the Access Code. Changing calibrations is also possible through proper linking with a computer (refer to the computer manual). The same security code restrictions exist. After gaining access, changes to calibrations can be accomplished (Figure 22).



Next Page Key



Previous Page Key



Enter Key

## To Enter/Change Calibration Values:

1. From the **Calibration** menu, press the 2 key to access **Enter/Change Calibration** screen.
  - (Blue model) PAGE 1 OF 8 of the **Select Grain To Enter/Change** menu displays. The remaining pages are accessed by selecting the **Next Page** and **Previous Page** keys.
2. Select the grain to be altered or locate an empty position to enter a new calibration. Select the appropriate key corresponding to the listing. A screen displays TO PROCEED, UNSEAL ACCESS PORT ON REAR PANEL and PRESS WHITE PUSHBUTTON.
  - (Blue model) If the grain selected is on one of the first five grain pages ( $5 \times 8 = 40$ ) changing the calibration is restricted to authorized personnel only.
  - (Blue model) If the grain selection is on pages 6, 7 or 8, these calibrations can be altered after responding to the request to ENTER ACCESS CODE.
  - (Blue model) Enter the access code and select the **Enter** key to proceed.

**IMPORTANT: Unsealing the access port should only be performed by an authorized user.**





Figure 22  
Changing Calibrations

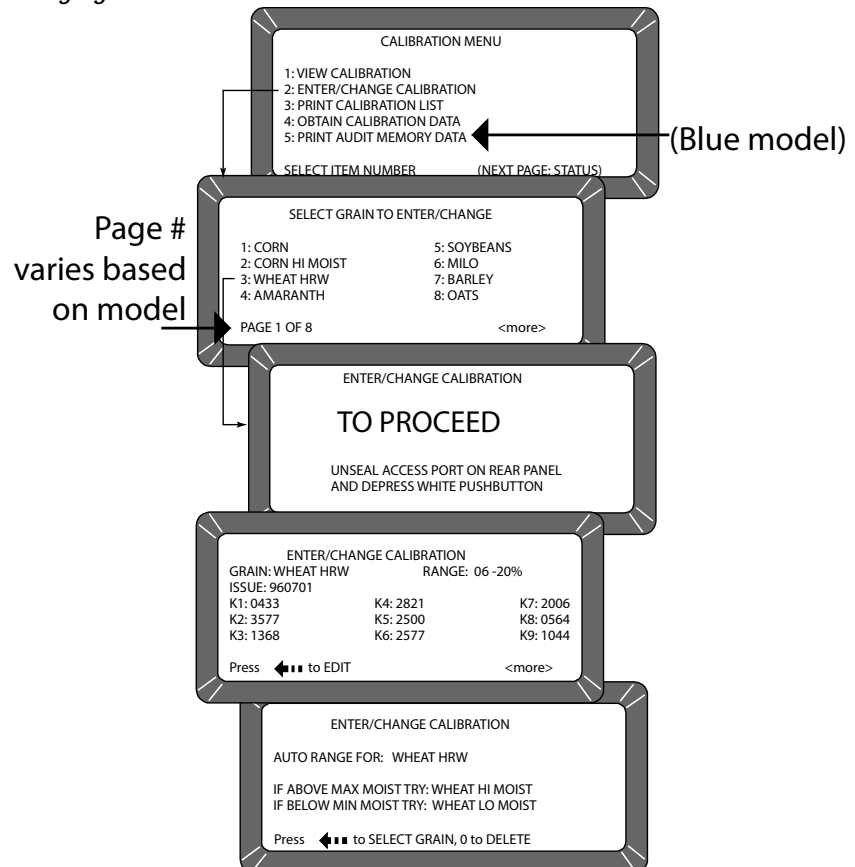

3. If selecting an existing calibration, a large flashing block appears on the grain selection. The screen displays the current K values for that grain. The large flashing block signifies that alpha characters can be entered from the alpha screen.

- Press the **Backspace** key, as prompted on the bottom of the screen, causes the bottom prompt to disappear and the large flashing block to change to a cursor (flashing line).
- When the cursor appears, the alpha screen may be accessed by selecting the **Next Page** key. If numeric entries are desired, those values are made directly with the number keys.

4. Use the alpha screen to enter a grain name (up to 16 characters).

- Select the **Enter** key after each character selection to place the character on the text line.

- Press the **Previous Page** key to return to the **Enter/Change Calibration** screen. Note that the new grain title is now in place.

5. Press the **Enter** key to accept the new grain title. The cursor advances to the next position (Issue Date).

6. Enter the Calibration Issue Date (up to 8 characters) and select the **Enter** key. The cursor returns to a flashing block in the ISSUE position. The block signifies the date may include alpha characters (i.e.



Backspace Key



Next Page Key

**NOTE:** Selecting the Next Page key instead of the Backspace key (to change the large flashing block to the cursor), advances to the AUTO RANGE function.



Enter Key



Backspace Key



Print Key

15NOV98) but normally is entered as numbers in a format such as YYMMDD (i.e. 981115).

- Pressing the **Backspace** key will cause the flashing block to disappear allowing the **Next Page** key to be used for selecting the alpha screen.
7. Press the **Enter** key to accept the date. The cursor appears as a line (flashing) under the first digit of K1 (constant). The flashing cursor (line) signifies this entry accepts only numbers.
  8. Enter the K1 constant. Notice when entering the first digit the remaining spaces are blank. All four digits of the constant must be entered when making a change. If more than four digits are entered, a long beep indicates an illegal entry.
  9. When finished, press the **Enter** key to accept the constant and to advance to the next position. If the screen is accidentally advanced before finishing, press the **Enter** key as many times as necessary to cycle through all menu items.
  10. Enter K2 through K9 constants in the same manner as K1.
  11. Press the **Enter** key after entering each constant (4 digits).
  12. Press the **Print** key to print the calibration. The present screen values print.
  13. Press the **Next Page** key to enter the **Auto Range** calibration selection. The **Auto Range** screen allows entry for grains using higher or lower moisture levels than the current calibration. These values are automatically selected if the grain moisture is outside the standard setting.
  14. Press the **Backspace** key and choose a grain calibration if the sample moisture is above the upper limit. After selecting a grain, the display will return to the **Auto Range** screen. Repeat this procedure again for the lower limit grain calibration.
  15. Press the 0 (zero) key to delete either auto range calibration.
  16. Press the **Previous Page** key to return to the **Grain Calibration** screen.

## PRINT CALIBRATION GRAIN LIST (3 KEY)

Grain calibrations stored in memory can be printed by selecting the **Print** key ([Figure 23](#)).

### To Print a Calibration List:

1. Press the 3 key from the **Calibration** menu. The **Print Calibration List** screen appears.
2. Select the **Print** key. The list of all grain calibrations will print.



*Figure 23*  
*Printing Calibration Lists*

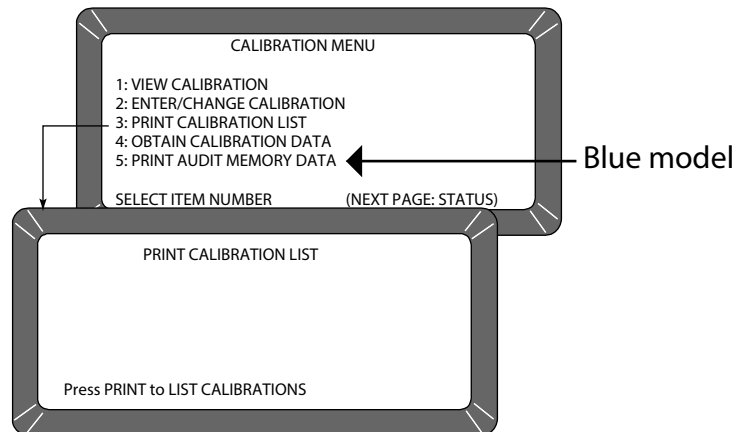

## OBTAIN BASIC CALIBRATION DATA (4 KEY)

This mode allows the user to generate data for developing grain calibrations. The samples used for calibration should span the desired moisture range.

**IMPORTANT:** To obtain good calibration data, the samples must be as evenly distributed throughout the moisture range as possible. The grain samples should extend at least 2% past each end of the desired moisture range, should contain no spoilage or condensation, and be free of broken pieces or foreign matter. The GAC 2100 readings obtained can be sent to DICKEY-john to derive the calibration constants for the new grain.

### To Obtain Accurate Calibration Constants:

1. Turn the power switch ON and allow approximately thirty minutes to warm up before taking sample readings.
2. Turn the printer ON.
3. Verify the instrument is set up and functioning properly.
4. From the **Main** menu, choose the **Calibration** menu by pressing the 3 key.
5. Press the 4 key and select OBTAIN CALIBRATION DATA.
6. Enter a sample identification number so the sample is properly identified. Key in a sample ID number (use the **Next Page** key if an alpha ID is desired).
7. Press the **Enter** key.
8. Pour the sample into the hopper and press the **Load** key.
9. After the measurement cycle is complete, the screen displays four D values (Figure 24). If using a printer, a printout automatically results. If a printer is not used, record the D-values and sample ID.



Next Page key



Enter Key



Load Key



*Figure 24*  
*Obtaining Calibration Data*

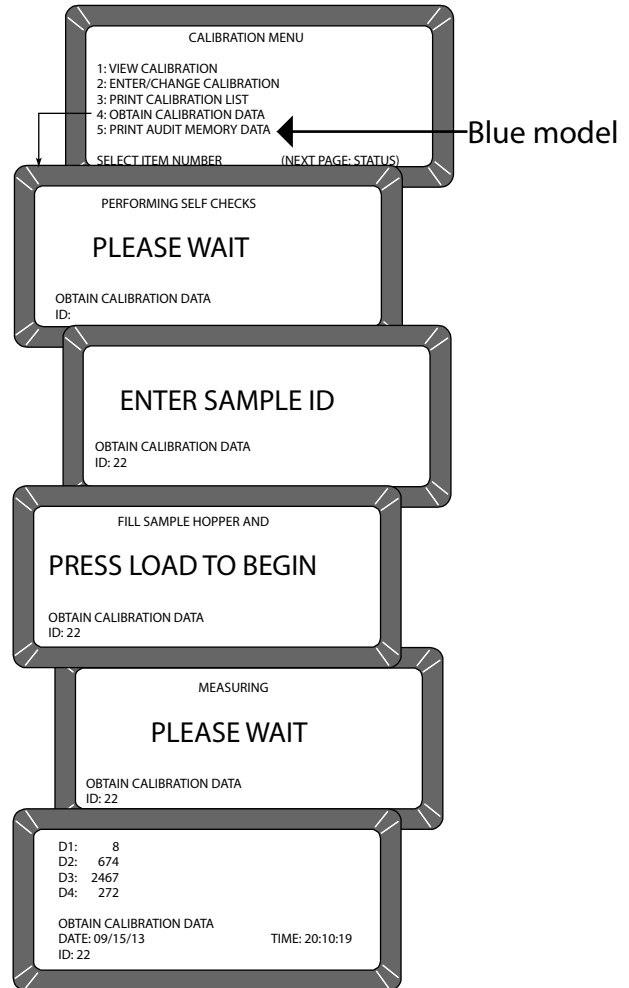

*NOTE: The facility name and location, date/time, GAC 2100 serial number and calibration data print when the first sample is run in this mode (Figure 25).*



Unload Key

10. Write the grain type under the CALIBRATION DATA. Write the actual moisture percentage of each sample (obtained by an accurate approved means) next to STD. MOIST.
11. Run additional samples and record the actual moisture percentage for each sample.
12. After running each sample, press the **Unload** key.



Figure 25

## Calibration Data Printout

```
DICKEY-JOHN
CORP_GAC 2100

09/29/16 10:32:28

S/N: 1737-90909

CALIBRATION DATA
=====

ID: 1.1

STD. MOIST:

D1: 0
D2: 672
D3: 2412
D4: 233
=====
```

## PRINT AUDIT MEMORY DATA (5 KEY)

### (Blue model)

The audit memory records data changes made to parameters affecting moisture measurement or the display of the measurement data. The audit memory stores the following types of data:

- Grain calibration settings
- Output option settings
- Date and time settings
- Moisture bias and slope adjustment settings

Memory contents can be printed at any time. Printing audit memory can be initiated from either the unit or the computer site (Figure 27). For additional information concerning printing from the computer, refer to the Communications Software manual included with the Communication software.

### To Print the Audit Memory Contents:

1. From the **Main** menu, access the **Calibration** menu by selecting the 3 key.
  - Access PRINT AUDIT MEMORY DATA by selecting the 5 key. A screen appears displaying PRESS PRINT TO BEGIN.
2. Press the **Print** key to obtain a printout of the audit memory (Figure 26). Multiple copies can be produced by selecting the **Print** key again when the printer finishes. If only the header, current date, current time, and GAC 2100 serial number print during this process, the audit memory is empty.



Print Key



Figure 26

Audit Memory Data

```

DICKEY-JOHN
40554

CURRENT DATE/TIME

29/09/16 10:32:28

S/N: 1716-40554

EVENT COUNTER: 1

DATE OF CHANGE:
09/29/16 MM/DD/YY
TIME OF CHANGE:
10.33.25 HH.MM.SS
LOG ON TIME:
00.00.00 HH.MM.SS
CHGCD:
000000

PID: TIME
10.34.00 HH.MM.SS

=====
    
```

Figure 27

Printing Audit Memory Data (Blue Model)

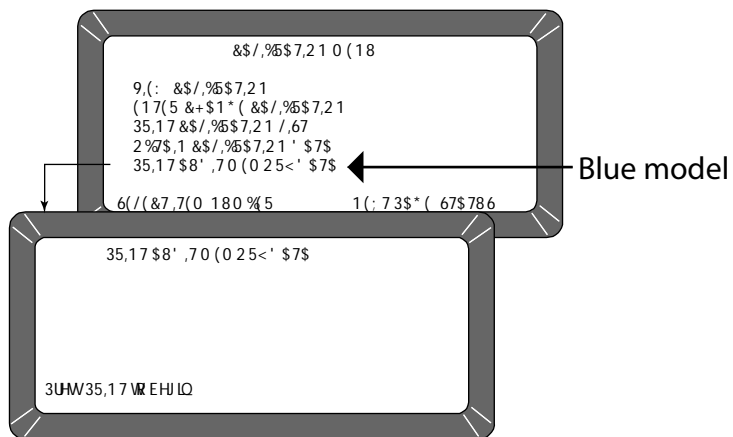

Previous Page Key

3. After printing, press the **Previous Page** key to return to the **Calibration** menu.



Each event lists the following items:

1. Date of change
2. Time of change
3. Log on time
4. User code (Figure 26).

The user code prints asterisks to maintain user code security. The event (or change) is identified with a PID (Parameter Identification), a colon and then a code to indicate the specific type of change (refer to Table 1). The printout begins with the most recent event and progresses in reverse order to the oldest event.

PID:	Definition of Terms
CB*	Calibration
USRCD	User Code
OO - D&OTW	Output Option - Display & Output Test Weight
OO - D & OT	Output Option - Display & Output Temperature
OO - DOOLR	Output Option - Display & Out-Of-Limits Results
OO - OOOLR	Output Option - Output Out-Of-Limits Results
OO - OROAE	Output Option - Output Report Of All Errors
OO - MPR	Output Option - Moisture Printout Resolution
OO - RP	Output Option - Radix Point
OO - TF	Output Option - Temperature Format
OO - WF	Output Option - Weight Format
TIME	Time
DATE	Date
DATE FORMAT	Date Format

## MEMORY FULL

### (Blue Model)

When the instrument reaches 1000 events, a memory full message displays and no additional events can be recorded until audit memory is cleared. The unit will not respond to keypad input and must be turned off and on to regain control and to resume normal grain measurement routines. If any attempt is made to modify an auditable parameter, the warning reappears and must be cleared again. This limitation persists until the memory is cleared.

*Figure 28*

*Audit Memory Full Screen*

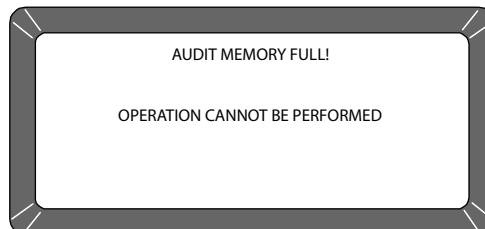



Previous Page Key

### After Printing Audit Memory:

1. Press the **Previous Page** key.
2. After printing, select (1 key) to clear audit memory or (2 key) to retain audit memory.

*Figure 29*

### *Printing Complete Screen (Blue Model)*

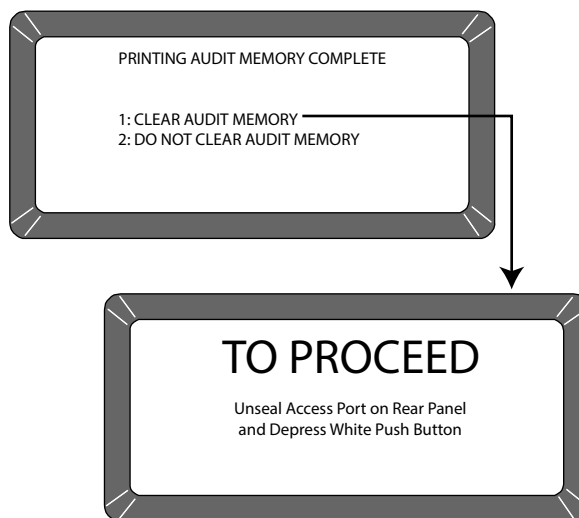

### To Clear Audit Memory:

Clearing Audit Memory should only be performed by an authorized user.

1. Press the (1 key) Clear Audit Memory on the display.
2. Locate the access port door located on the back of the instrument and remove seal, if necessary, from the door.
3. Remove screw to open access port door.
4. Press the white security button located on the bottom of the circuit board to advance to the next screen.
5. When the white push button is pressed, audit memory is cleared and the unit returns to the Calibration menu.



# OPERATOR'S MANUAL

---





## INSTRUMENT SETUP

The **Setup** menu establishes basic operating parameters for the unit.

These parameters include:

- Resetting the cycle counter
- ID options
- Output options
- Setting the access code
- Setting date and time
- Entering labels
- Configuring communication ports

From the **Main** menu, the **Setup** menu is accessed by selecting the 4 key. From the **Setup** menu, eight sub-menus will appear. Most functions require the access code before changes can occur. If the access code has not been changed, the factory installed temporary code is set for 0 (zero).

*Figure 30*

### Setup Menu Choices

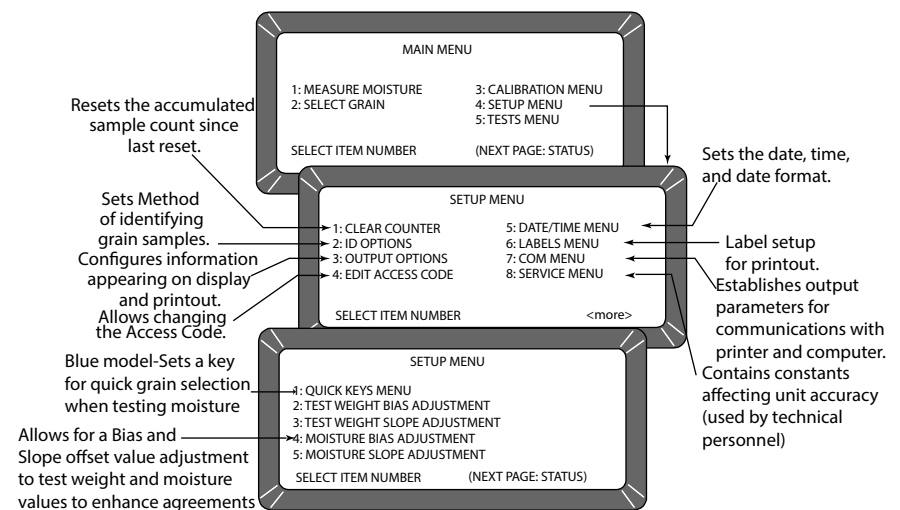

## CLEAR CYCLE COUNTER (1 KEY)

The CYCLE COUNTER increments once each time a moisture measurement or data collection sequence is successful. The screen displays the total counts accumulated since the last reset.

### To Reset the Cycle Counter:

1. From the **Setup** menu, press the 1 key (**NOTE:**). A screen displays ENTER ACCESS CODE.
2. Enter the current personal access code (or 0) and press the **Enter** key. Enter 0 if the code has not been changed from factory settings.



Enter Key



3. Press the **Enter** key again to reset the number (count) to zero. The counter returns to zero.

*NOTE: The date, time, and cycle counter values are automatically sent to the COM1 and COM2 ports each time the counter is cleared resulting in a printout of the most recently cleared counter contents. The printout should be retained for records. Com 2 Baud Rate is 115,200, 8 data bits, no parity, and 1 stop bit.*

*Figure 31  
Clearing The Cycle Counter*

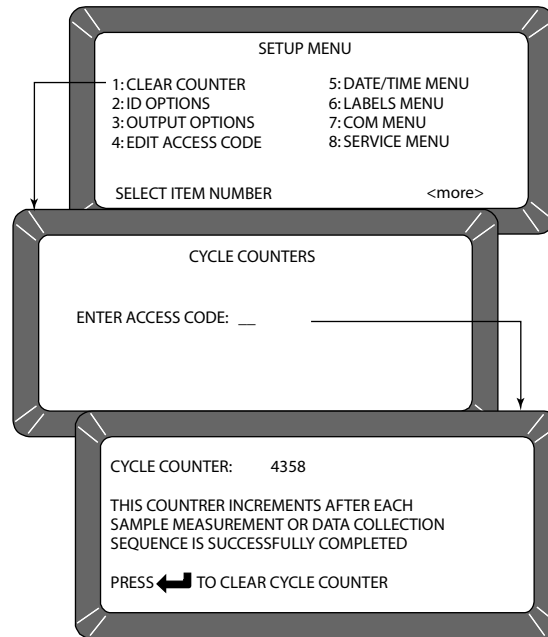

## ID OPTIONS (2 KEY)

ID OPTIONS determines how each moisture measurement sample is identified on the output data. ID numbers appear in the lower left corner of each test result screen. All sample ID numbers can contain up to 16 alphanumeric characters. Three methods of sample identification are available for display:

- **Automatic Sequential ID** – Automatically increments once for each measurement cycle, but resets each time the unit is turned OFF.
- **Enter Required for ID** – With each measurement, a screen displays ENTER SAMPLE ID before the grain sample is measured. This option ensures a grain sample identification number/label is assigned for each test printout.
- **Optional Entry ID** – If both of the selections have been checked NO, the ID number can be added to each measurement manually or not at all. Manually added ID numbers do not require any specific format or sequencing.

### To Configure the ID Options:

1. From the **Setup** menu, select the 2 key to access the **ID Options** screen (Figure 32). A screen displays ENTER ACCESS CODE.
2. Enter the access code (or 0) and select the **Enter** key. The **ID Option** screen displays only two lines but allows three choices – the AUTOMATIC SEQUENTIAL ID and ENTER REQUIRED FOR ID functions cannot both be enabled (YES) at the same time.



Enter Key

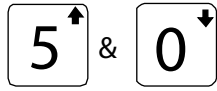

Up/Down Arrow Keys

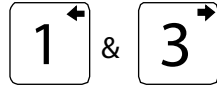

Left/Right Arrow Keys

3. Select the desired function. Use the **Up/Down Arrow** keys (0 and 5 keys) to select and the **Left/Right Arrow** keys (1 and 3 key) to set the desired value. If both selections are set to NO, grain sample ID is optional for each test.

*Figure 32*

### Selecting ID Options

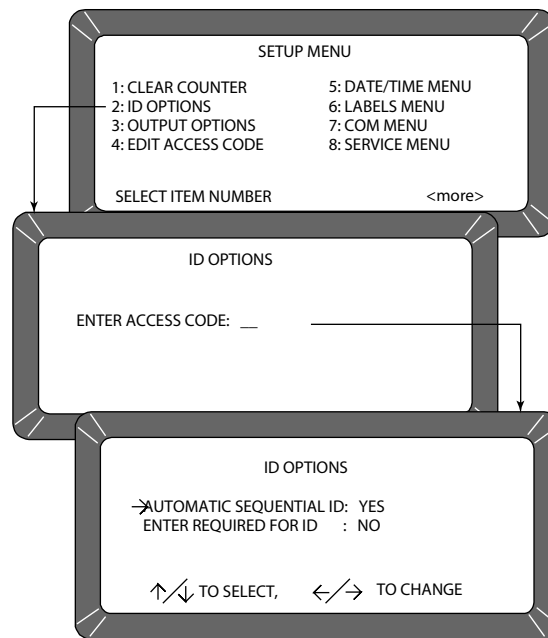

## CONFIGURE OUTPUT OPTIONS (3 KEY)

OUTPUT OPTIONS configure information appearing on the display/printer for measured test results (Figure 34). These selections are typically made once and not changed again, but may be altered as necessary. Selections are available only to authorized personnel through either the User ID Code from the computer site or as outlined below.

### To Change the Output Options:

1. From the **Setup** menu, select OUTPUT OPTIONS (3 key). A screen displays instructions on how to proceed.

### Locating the Instrument Security Button:

2. Locate the access port door located on the back of the instrument and remove seal, if necessary, from the door.
3. Remove screw to open access port door.
4. Press the white security button located on the bottom of the circuit board to advance to the next screen.



*Figure 33*  
*Security Button Location*

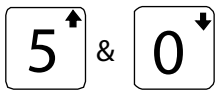
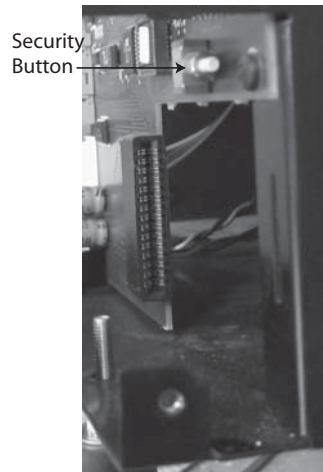

Up/Down Arrow Keys

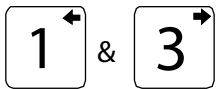

Left/Right Arrow Keys

5. Verify each option and set as necessary. Three pages must be verified (Figure 34). Use the **Up/Down Arrow** keys (0 or 5) to select functions and the **Left/Right Arrow** keys (1 or 3) to set each function to the appropriate setting. Options include:
  - **DISPLAY AND OUTPUT TEST WEIGHT:** Enables/disables (YES/NO) approximate grain test weight to display and print.
  - **DISPLAY AND OUTPUT TEMPERATURE:** Enables/disables (YES/NO) grain temperature to display and print.
  - **DISPLAY OUT-OF-LIMITS RESULT:** Error messages flash on the display each time tested grain parameters exceed the normal range of that particular grain. If enabled, three standard parameters display – moisture, grain temperature, and approximate grain test weight. Each measured parameter value appears next to its respective legend on the display. The display out-of-limit options selected below establish whether or not the enabled values appear on the display. Eight separate settings are available for suppressing the enabled grain parameters.
  - **OUTPUT OUT-OF-LIMITS RESULT:** If enabled, three standard parameters are printed – moisture, grain temperature, and approximate grain test weight. Each measured parameter value appears next to its respective legend on the printout. The output out-of-limit options selected establish whether or not the enabled values print. These choices are identical to the display out-of-limits conditions above and are selected in a similar fashion.

#### SETTINGS:

1. **YES** - Enabled readings display for all out-of-limit conditions.
2. **NO** - Enabled readings do not display for any out-of-limit condition.
3. **M** - Enabled readings display if moisture is out-of-limits but do not display if either weight and/or temperature is out-of-limits.
4. **W** - Enabled readings display if weight is out-of-limits but do not display if either moisture and/or temperature is out-of-limits.
5. **T** - Enabled readings display if temperature is out-of-limits but



- do not display if either weight and/or moisture is out-of-limits.
- 6. **MW**- Enabled readings display if moisture and/or weight is out-of-limits but do not display if temperature is out of limits. This is the current approved setting for NTEP units.
- 7. **MT** -Enabled readings display if moisture and/or temperature is out-of-limits but do not display if weight is out-of-limits.
- 8. **WT** - Enabled readings display if weight and/or temperature is out-of-limits but do not display if moisture is out-of-limits.
- **OUTPUT REPORT OF ALL ERRORS:** Enables all internal checked errors to print.
- **MOISTURE PRINT RESOLUTION:** Selects the resolution to either one tenth (0.1) percent or one hundredth (0.01) percent for moisture printout.
- **RADIX POINT:** Selects a decimal point ( . ) or comma ( , ) to display and printout.
- **TEMPERATURE FORMAT:** Selects either degrees C (°C) or degrees F (°F) to display and print for temperature.
- **WEIGHT FORMAT:** Selects either pounds per bushel (lb/bu) or kilograms per hectoliter (kg/hl) to display and print.



*Figure 34*  
*Setting Output Options*

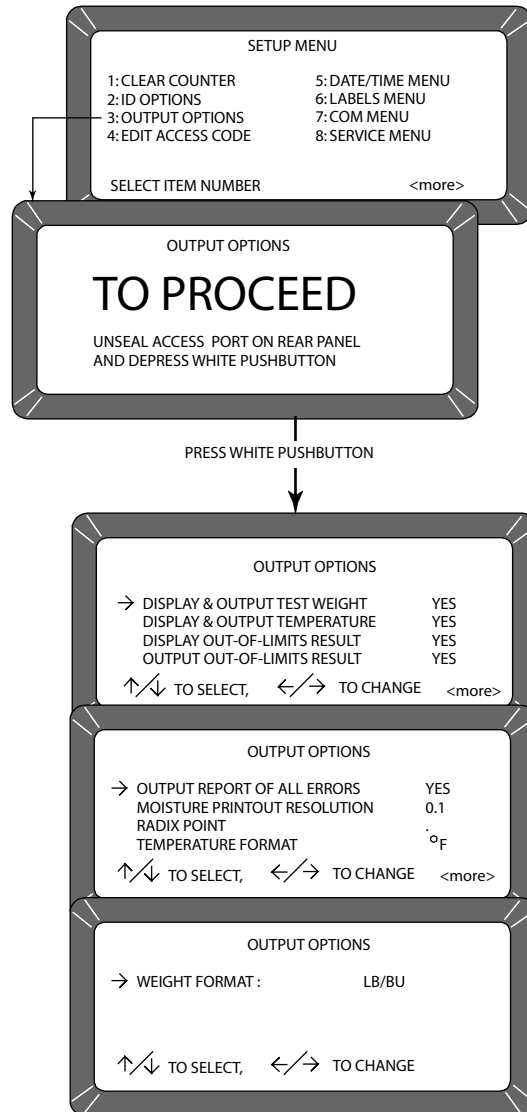

## CHANGE THE ACCESS CODE (4 KEY)

The Access Code establishes a security level for nearly all **Setup** Menu functions.

**Blue Model:** The Access code also allows modifying the unprotected grain calibrations to the instrument. (refer to CALIBRATE PROCEDURES). A higher security level is reserved for authorized personnel to make official grain calibration changes and requires breaking the seal on the rear panel of the unit and pressing the push button inside the access panel.



The access code is set to 0 when shipped from the factory. After selecting a different code, record the new number and store for safe keeping. DO NOT lose the new code. Contact DICKEY-john or your local authorized service center to recover the access code.



Enter Key



Previous Page key

### To Change the Access Code:

1. From the **Setup** menu, select the EDIT ACCESS CODE (4 key). The screen displays ENTER ACCESS CODE.
2. Enter the present code (or 0 if set at factory code) and press the **Enter** key. The **Edit Access Code** screen displays a blank (to be filled in). The present access code appears to the right (Figure 35).
3. Enter the new access code. Choose any numeric code of up to 4-digits.
4. Enter the number and press the **Enter** key. The new number must be used from this point forward to enter the access code level secured screens.
5. Press **Previous Page** to exit.

Figure 35

### Changing The Access Code

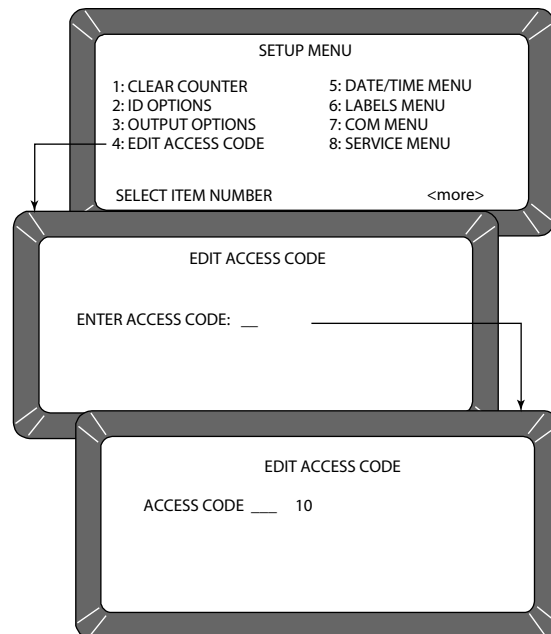





Enter Key



Previous Page Key

## CHANGE DATE, TIME, AND DATE FORMAT (5 KEY)

This function establishes correct date and time for display and print out with each grain moisture measurement.

### To Set the Time:

1. From the **Setup** menu, select the **Date/Time** menu (5 key). Three options are available; (1) SET TIME, (2) SET DATE and (3) SET DATE FORMAT (Figure 36).
2. From the **Date/Time** menu, select SET TIME using the 1 key. The **Set Time** screen appears and displays ENTER ACCESS CODE.
3. Enter the access code and select the **Enter** key. The time displays based upon a 24-hour clock.
4. Change the time by entering new numbers from the keyboard. The time format is in hours, minutes, seconds (HH.MM.SS). Each unit is two digits and is separated by a decimal point.
  - For example, to enter 3:32:59 P.M., enter 15.32.59. Use decimal points to separate units. If accuracy is desired, set the time slightly ahead and wait. At the exact time, press the **Enter** key to start the clock.
5. Press **Previous Page** to exit.

Figure 36

### Setting The Time

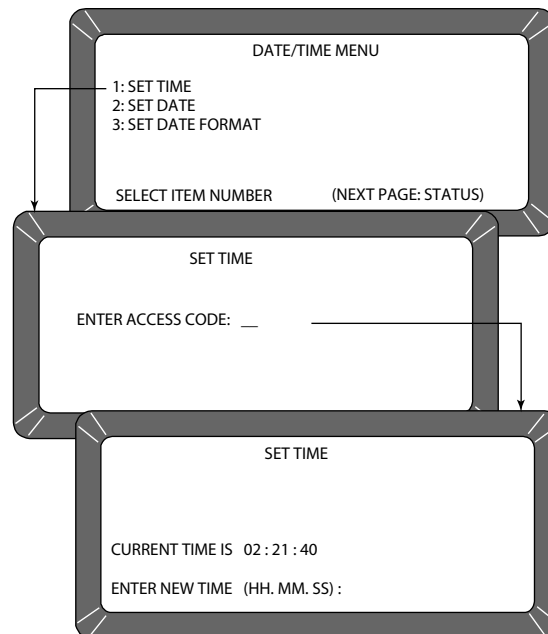



Enter Key



Previous Page Key

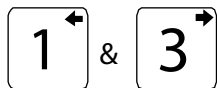

Left/Right Arrow Keys

## To Change the Date:

1. From the **Date/Time** menu, select the SET DATE (2 key) menu (Figure 37). The **Set Date** screen displays ENTER ACCESS CODE.
2. Enter the access code to gain and select the **Enter** key. Enter numbers in the format shown at display bottom: month.day.year. Each date component is two digits in length and separated by a decimal point (i.e. to enter 9/15/16, enter 09.15.16). The number appears on the left end of the bottom line.
3. Press the **Enter** key to accept the corrected date.
4. Press the **Previous Page** key to return.

Figure 37

Setting The Date

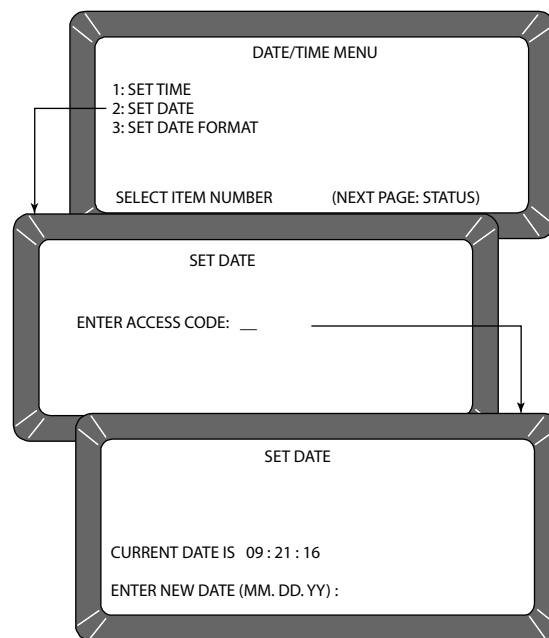

## To Change the Date Format:

1. From the **Date/Time** menu, select the SET DATE FORMAT (3 key) menu (Figure 38). The screen displays ENTER ACCESS CODE.
2. Enter the access code and press the **Enter** key. The date format can be configured in one of three formats:
  - MM/DD/YY
  - DD/MM/YY
  - YY/MM/DD.
3. Press the **Left** or **Right Arrow** keys (1 or 3) to select one of the three formats.
4. When finished, press the **Left** or **Right Arrow** keys to accept the choice and return to the **Date/Time** menu.
5. Press the **Previous Page** key once more to return to the **Setup** menu.



*Figure 38*  
*Setting Date Format*

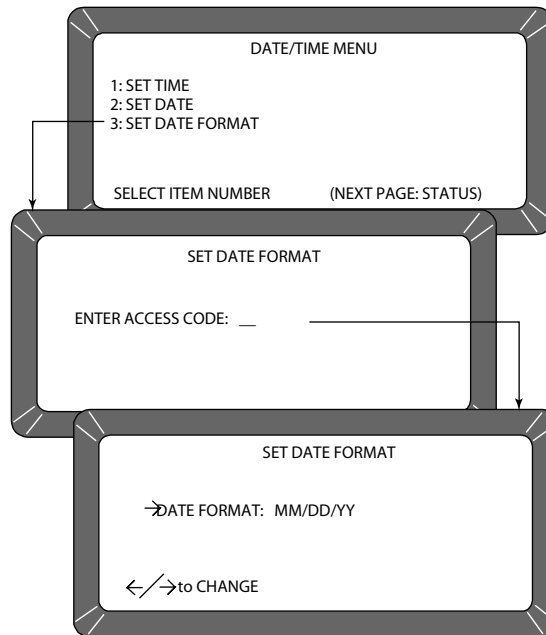

## CHANGE LABELS (6 KEY)

The **Labels** menu edits three label types:

- user name
- text strings (Blue model)
- factor names (Blue model)

Each of these labels attach to the grain moisture measurements in some fashion. Editing of each label type is similar. The basic procedure is outlined in the following five steps. Specific details and illustrations for each label follow the basic outline.

- **USER NAME** – This heading appears on each measurement printout (not the display) and can be the organization's name. The user name can be two lines of up to 16 characters each.
- **TEXT STRINGS** – (Blue model) These are brief, commonly used words or phrases added to the alpha screen for quick selection (e.g., a name, company, etc.) when using alpha characters. After programming, each phrase is selected in the same manner as choosing a single character. Up to ten text strings can be preset. Each string is identified on the alpha screen by an S number (S1 through S10).
- **FACTOR NAMES** – (Blue model) These are entered as identifiers of specific details for particular grains. When using factors with particular grains, each factor name must be entered before the test can proceed.



*Figure 39*  
*Editing User Name*

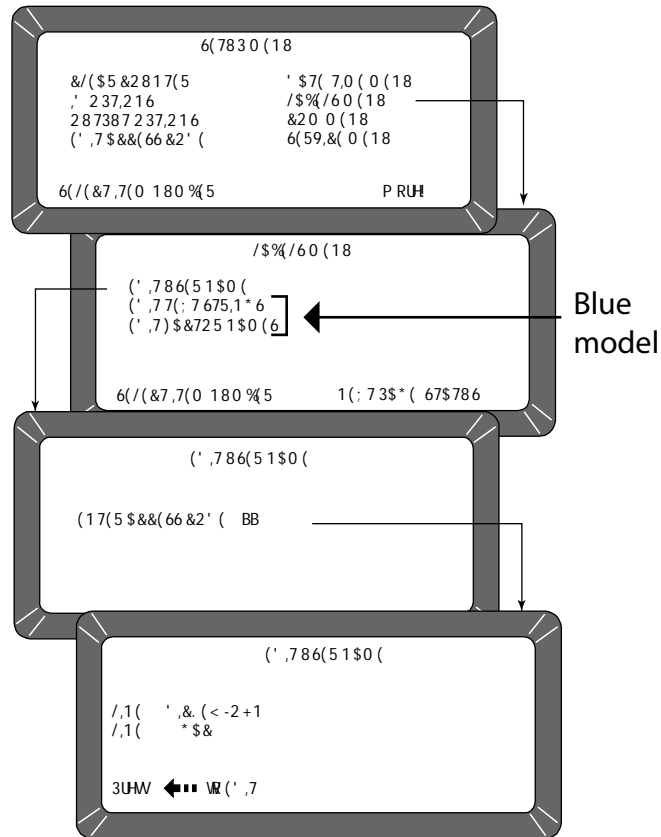

**To Create Labels:**

1. From the **Setup** menu, select the **Labels** menu (6 key). The **Labels** menu offers choices:
  - edit user name
  - edit text strings (Blue model)
  - edit factor names (Blue model)
2. Choose the label of interest by selecting the key number next to the label type. The **Enter Access Code** screen displays.
3. Enter the access code and then select the **Enter** key. For the user name (Figure 39) or the text string (Figure 40) screens, a large flashing block highlights the first character to edit.
4. Press the **Backspace** key as directed by the prompt on the bottom corner of the display. The prompt disappears and is replaced with a cursor (underline) beneath the first character of the first line.
  - (Blue model) FACTORS (e.g., customer id, vehicle no, load weight, etc.) are assigned to individual grains. For factor names (Figure 41), the **Select Grain To Enter/Change** menu appears and requests the selection of a grain name to assign the factor(s). Up to



Enter Key



Backspace Key



Enter Key



Previous Page Key

- four factors can be assigned to each grain. After selecting a grain, the EDIT FACTOR NAMES will appear for entry.
- To delete existing factor names from the grain calibration, begin by selecting the grain and the factor name to be deleted.
  - Select the **Backspace** key first, then any numeric key.
  - Press the **Backspace** key a second time and then select the **Enter** key. The factor name should be blank.
5. Enter the selected characters/numbers to reflect the label. Numbers and letters can be mixed by using the alpha screen.
  6. When completed, press the **Previous Page** key to return to the **Labels** menu.

Figure 40

Edit Text Strings (Blue Model)

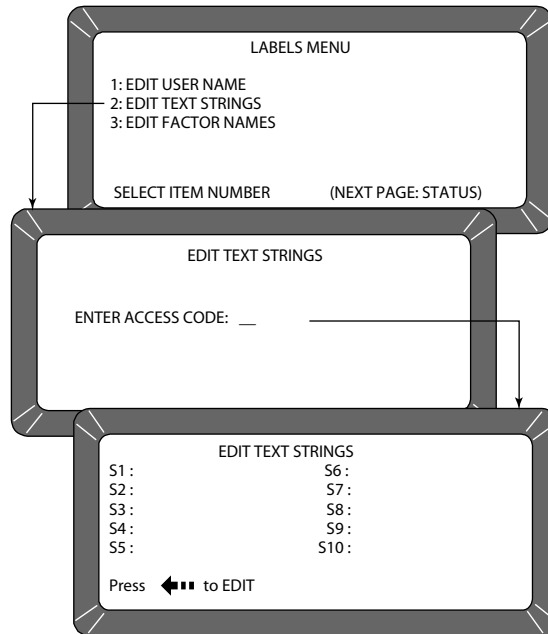
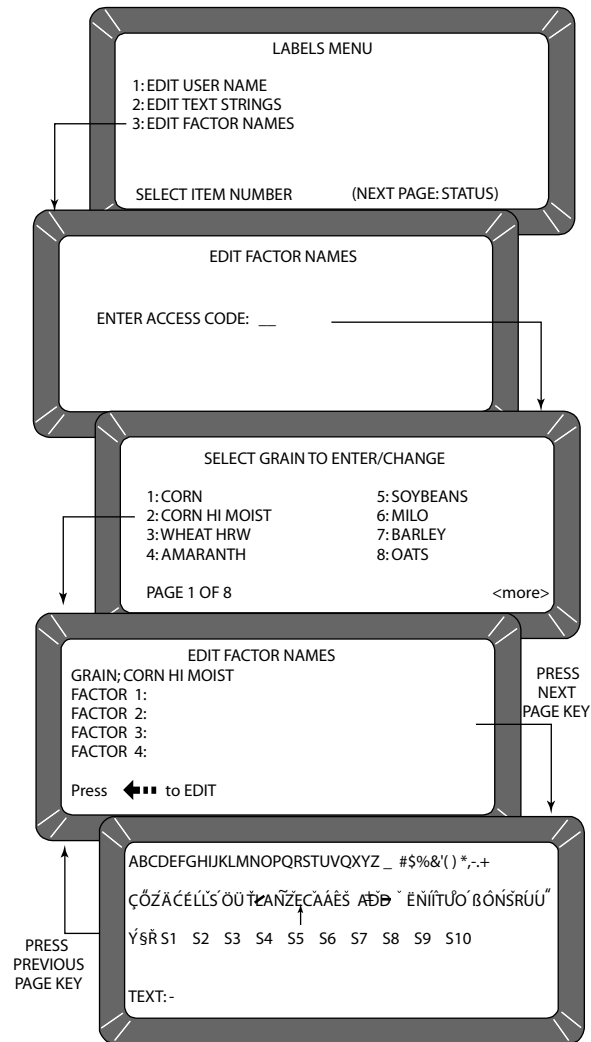



Figure 41  
Edit Factor Names (Blue Model)



## SET COMMUNICATIONS PORT PARAMETERS (7 KEY)

*NOTE: Com 1 does not require a null modem when communicating to a printer or computer. Com 2 requires a null modem to communicate with a computer or a printer.*

The **COM (Communications)** menu is accessed through the Setup menu by pressing the 7 key. From this menu, output parameters are selected for communicating with external devices such as a PC computer and/or a printer. Two port connectors appear on the rear of the unit directly above the sealed access cover.

The COM1 (Data Communications Equipment) port connector is located above the COM2 (Data Terminal Equipment) port connector. The **COM** menu contains eight items with number 5 non-active. Selections 2, 3, and 4 configure the COM1 port while 6, 7, and 8 configure the COM2 port. Each of the **COM** menu items is edited in a similar fashion.



## To Configure the Communications Ports

(Basic entry procedure – Followup to specific subject for finishing details):

1. From the **Main** menu, select the 4 key (**Setup** menu) and then the 7 key (**COM** menu).
  - The **Communications** menu appears with seven active choices and one non-active selection.
2. Choose the desired function by selecting the key number next to the choice. The **Enter Access Code** screen appears.
3. Enter the access code and then select the **Enter** key.
  - The selected COM screen appears ready for editing.
4. Proceed with the necessary editing of the selection.
 

The selections are:

  - COM port select
  - COM1 or COM2 format
  - COM1 or COM2 serial data setup
  - COM1 or COM2 control lead setup



Enter key

Figure 42

### Accessing the COM Menu

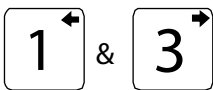
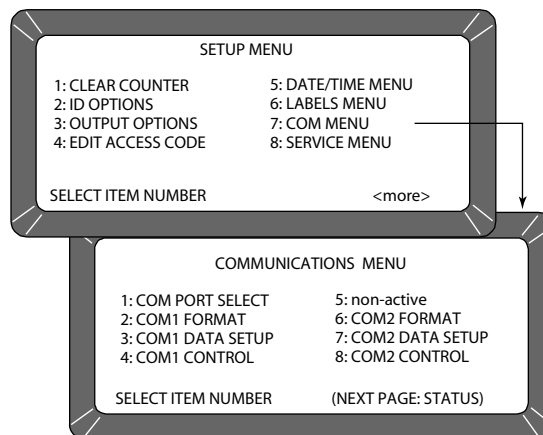

Left/Right Arrow Keys

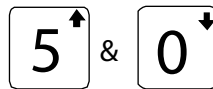

Up/Down Arrow Keys

### To Configure COM PORT SELECT:

Press the 1 key on the **Communications** menu:

1. After completing steps 1 through 4 from the basic entry procedure, edit the configuration.
  - Four items appear on the menu for editing and configuring output information of both ports (COM1 and COM2).
  - Each item may be set to NONE, COM1, COM2 or COM1/COM2 (both ports) using the **Left/Right Arrow** keys to cycle through the choices.
  - The pointer in front of each item can be moved with the **Up/Down Arrow** keys.



Print key



Previous Page Key

The four outputs are defined as follows (Figure 43):

- **AUTOMATIC RESULTS OUTPUT** - The configured port produces an output to automatically print the moisture results.
- **MANUAL RESULTS OUTPUT** - Produces a printout for the configured port of the results by selecting the **Print** key. Repeatedly selecting the **Print** key results in duplicate copies.
- **ERROR REPORT OUTPUT** - The configured port produces a printout of errors occurring during internal self checks. Out of limit errors of measured results do not print.
- **SETUP AND TEST OUTPUT** - The configured port produces a printout of setup and test data by selecting the **Print** key.

2. Once editing is complete, select the **Previous Page** key to return to the **Communications** menu and for the next selection.

Figure 43

Accessing COM Port Select

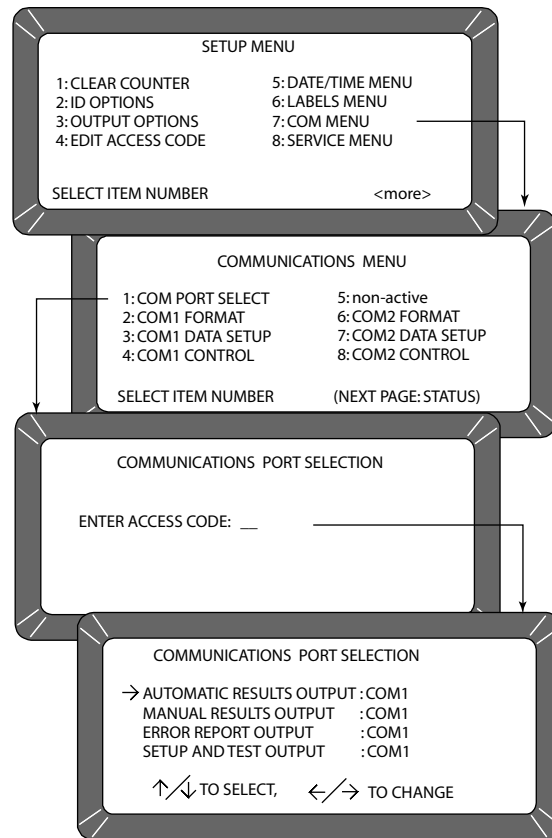





## To Configure COM1 or COM2 Format:

(2 or 6 key from the **Communications** menu):

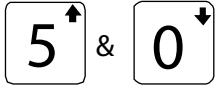

Up/Down Arrow Keys

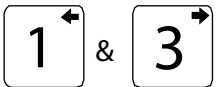

Left/Right Arrow Keys



Previous Page Key

1. After completing steps 1 through 4 from the basic entry procedure, edit the configuration. Both the COM1 FORMAT and COM2 FORMAT selections are similar and therefore are described together. The **COM Format Selection** menu displays two lines each containing several choices (Figure 44).
2. Select the OUTPUT FORMAT using the pointer. Place the pointer in front of the correct line with the **Up/Down Arrow** keys.
3. Edit the line by using the **Left/Right Arrow** keys to cycle through six variations. Select the appropriate format from the following six choices:
  - PRN20 - Standard 20 column printer output.
  - PRN80 - Standard 80 column printer output.
  - TST20 - 20 column test output of printer parameters.
  - PRN81 - Standard 80 column printer output (2 lines).
  - CSV01 - Comma separated variables.
  - PRN21 - Special 20 column printer output. PRN 20 format with the Grain Calibration Date Code, Instrument Serial Number and D-values removed.
4. Select the LINE TERMINATOR with the pointer. An RS-232 line of input data must be terminated with one of the following characters or character pairs.
  - LF (Line Feed) 0A Hex
  - CR (Carriage Return) 0D Hex
  - LF + CR 0A, 0D Hex
  - CR + LF 0D, 0A Hex
5. After editing is complete, select the **Previous Page** key to return to the **Communications** menu for the next selection.



*Figure 44*  
*Setting Output Format*

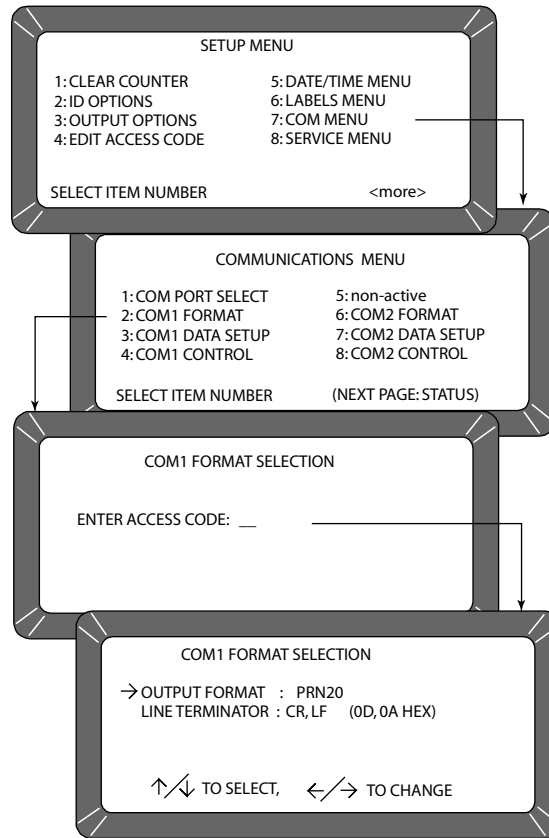

### To Configure COM1 or COM2 SERIAL DATA SETUP:

(3 and 7 keys on the **Communications** menu)

Both the COM1 and COM2 SERIAL DATA SETUP selections are similar and therefore described together.

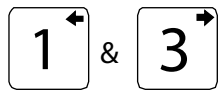

Left/Right Arrow Keys

1. After completing Steps 1 through 4 from the basic entry procedure, edit the configuration.
  - Either of the **COM Serial Data Setup** menus display four lines, but only the top line (Baud rate) can be changed for the COM1 SERIAL DATA SETUP (Figure 45).
2. Select the baud rate line for the COM1 SERIAL DATA SETUP of the printer. Use the **Left/Right Arrow** keys (1 or 3 key) to cycle the Baud Rate through seven choices: 300, 600, 1200, 2400, 4800, 9600, and 19200 bits/second. Choose the one that matches the rate of the equipment in use.

**IMPORTANT:** COM2 data baud rate will always remain at 115200, Data Bits at 8, Parity None, and Stop Bits at 1 even though the options to change are available in the menu. The device connecting must change to match the instrument's baud rate.



3. Select the DATA BITS, PARITY and STOP BITS in that order. The items for the COM1 and COM2 port cannot be changed:
  - DATA BITS – Set for 8-bit character lengths.
  - PARITY – Set to NONE by using the **Left/Right Arrow** keys.
  - STOP BITS – Set to 1.
4. After editing is complete, select the **Previous Page** key to return to the **Communications** menu for the next selection.

*Figure 45*

*Accessing the COM1 Serial Data Setup Screen*

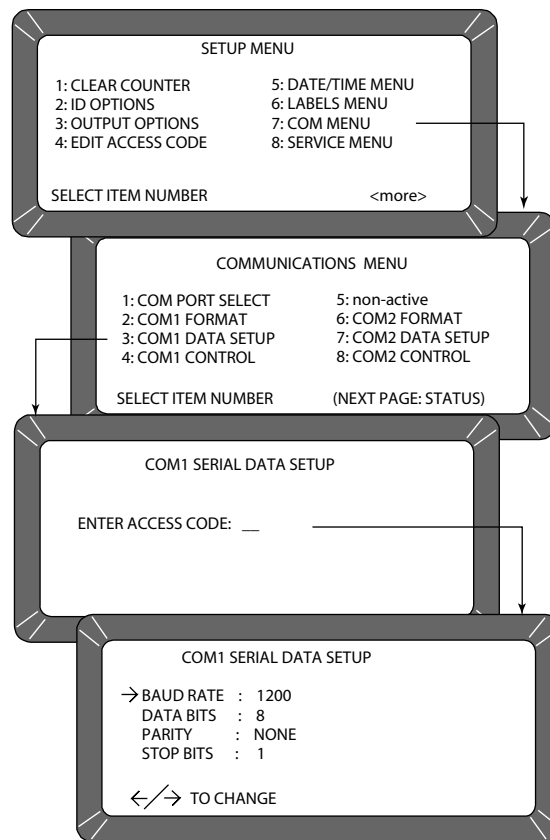

### To Configure COM1 or COM2 CONTROL LEAD SETUP:

(4 or 8 Keys from the **Communications** menu):

Both the COM1 and COM2 CONTROL LEAD SETUP selections are similar and therefore described together in this procedure (Figure 46). Differences are noted as applicable.

1. After completing steps 1 through 4 from the basic entry procedure, edit the configuration of the COM1 Port screen. The **COM1 (DCE) Control Lead Setup** menu displays two lines, refer to **Accessing COM Control Lead Setup** screens.

The busy line, BUSY (11), notifies the GAC 2100 when the buffer in the printer (computer) is full and cannot accept more data. The polarity of this line is important and is set to be compatible with the printer. The



Previous Page key

control lead busy sense has three polarity choices: IGNORE, ACTIVE (+), or ACTIVE (-).

The DTR (20) (data terminal ready) line notifies the GAC 2100 that the printer (computer) is turned ON. The Control Lead DTR Sense has two states: IGNORE or ACTIVE.

2. Edit the configuration of the COM2 Port screen. **Control Lead Setup** menu displays seven items but only three lines can be edited.
  - MODE : TRANSMIT ONLY or AUTO ANSWER (**Blue model**)
  - RTS (4): ON (+) or AUTO
  - DSR (6): IGNORE or ACTIVE
3. After editing is complete, select the **Previous Page** key to return to the **Communications** menu for the next selection.

*Figure 46*

*Accessing COM Control Lead Setup Screen*

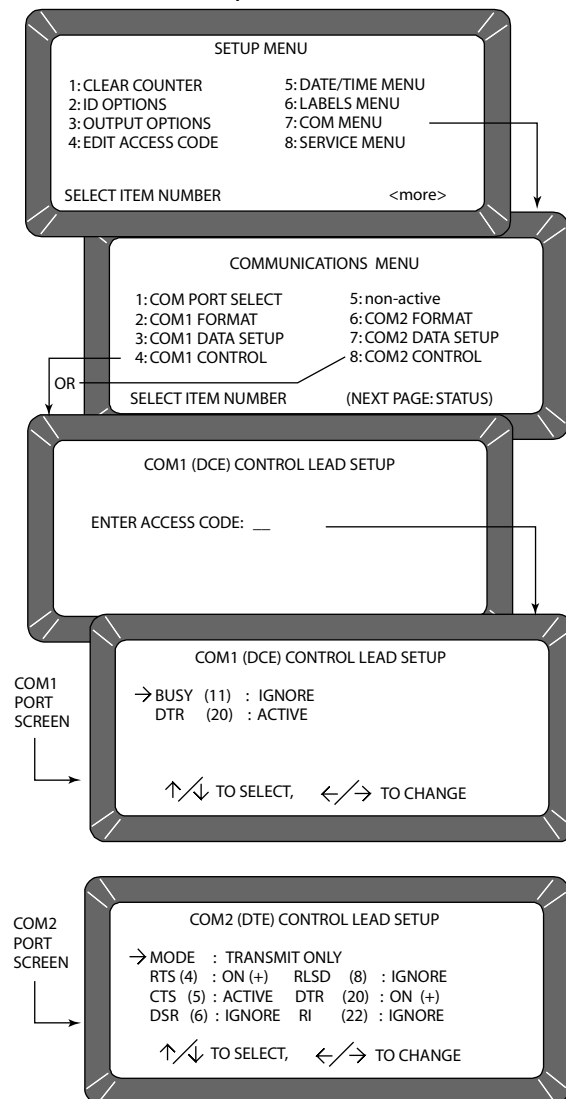



Figure 47

## Definitions Of Common Acronyms

BUSY	– Line busy	DTR	– Data Terminal Ready
CTS	– Clear To Send	RI	– Ring Indicator
DCE	– Data Communications Equipment	RLSD	– Receive Line Signal Detect
DSR	– Data Set Ready	RTS	– Request To Send
DTE	– Data Terminal Equipment	RxD	– Receive Data
		TxD	– Transmit Data

## NON-ACTIVE (5 KEY FROM COMMUNICATIONS MENU)

The non-active selection (Figure 46) has no function and only emits a long beep when pressed. No other action results.

## SERVICE MENU (8 KEY)

The **Service** menu contains individual unit calibration constants and is accessed by DICKEY-john trained and equipped service personnel.

## QUICK KEYS MENU

### Blue Model-

QUICK KEYS makes changing between frequently-used grains easier during moisture measurements by bypassing the **Select Grain** menu. Up to three frequently used grains can be programmed for keyboard keys 1, 2, and 3. The desired key (grain) changes the grain to be tested whenever the **Press Load To Begin** screen appears just prior to starting the moisture measuring cycle.

### To Program a Quick Key:

1. Select the 4 key (**Setup** menu) from the **Main** menu and then the **Next Page** key to access PAGE 2 of the **Setup** menu.
2. Select the 1 key to choose the **Quick Keys** menu. Three choices are available (Figure 48).
3. Select 1, 2 or 3 to program as a Quick Key. The **Enter Access Code** screen will appear.
4. Enter the access code and select the **Enter** key. The **Program Quick Key** screen will appear.
5. Use the **Left/Right Arrow** keys to select the desired grain. The grain name and the number to the right will change with each key stroke. Keep advancing until the correct grain is located. When the end is reached, the list wraps around to the beginning and starts again.
6. Press the **Previous Page** key to accept the selection.
7. Repeat the process to program or change each Quick Key as desired.



Next Page Key



Enter Key

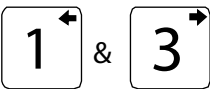

Left/Right Arrow Keys



Previous Page Key



Figure 48

Programming The Quick Keys

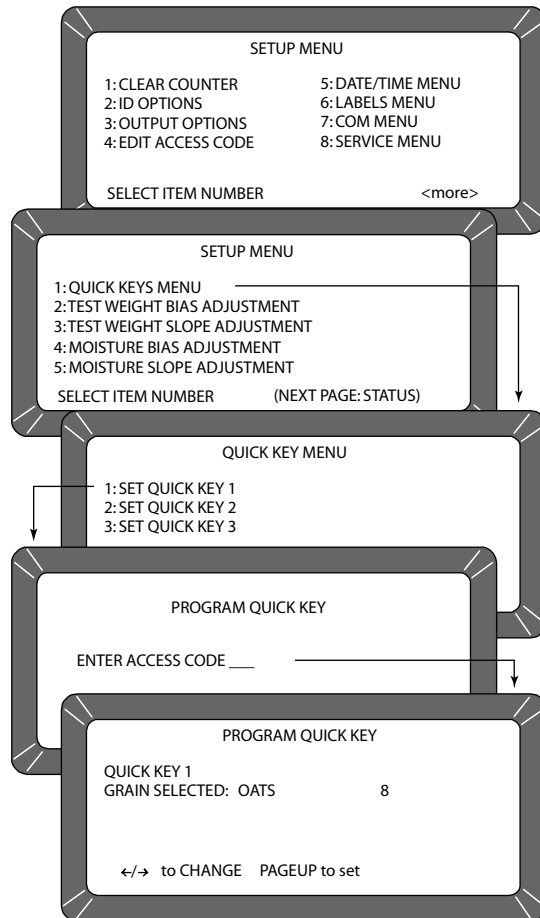

Next Page Key



Enter Key

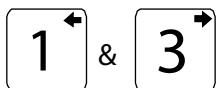

Left/Right Arrow Keys

## TEST WEIGHT BIAS ADJUSTMENT (SELECT MODELS ONLY)

Test weight bias adjustment allows entering a correction factor for differences between the GAC 2100 grain test weight and the official test weight reference. An offset value can be introduced by authorized personnel.

**IMPORTANT: A bias value should only be changed by an authorized user.**

### To Change the Test Weight Bias:

1. Press the 4 key (**Setup** menu) from the **Main** menu and then the **Next Page** key to access PAGE 2 of the **Setup** menu.
2. Press the 2 key (Blue model) or press the 1 key (AGRI and Gray models) to choose TEST WEIGHT BIAS ADJUSTMENT. (Figure 49).
3. Enter the access code and press the **Enter** key.
4. Use the **Left/Right Arrow** keys to select the grain type for correction. The grain name and its number to the right change with each key stroke. Advance until the correct grain displays. If the end of the list is reached, the list wraps to the beginning and starts again.

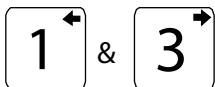

Left/Right Arrow Keys

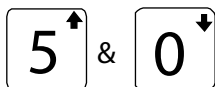

Up/Down Arrow Keys



Previous Page Key

**NOTE:** When a grain measurement is taken, an asterisk (\*) appears in front of the test weight value to indicate a test weight bias is enabled.

5. When the correct grain is found, press the **Enter** key. The final screen appears for editing the TEST WEIGHT BIAS OFFSET value. The adjustment consists of three settings— the whole number, tenths and hundredths.
6. Press the **Left/Right Arrow** keys to select the desired digit to change.
7. Change the selected value with the **Up/Down Arrow** keys. The value of the number is monitored on the TEST WEIGHT BIAS ADJUSTMENT line toward the bottom of the screen.
8. When finished, press the **Enter** key to accept the final bias value.
  - An asterisk appears next to the value to indicate the number is recorded and a test weight bias has been applied.
9. Press the **Previous Page** key to return to the **Setup** menu.

Figure 49

### Setting The Test Weight Adjustment

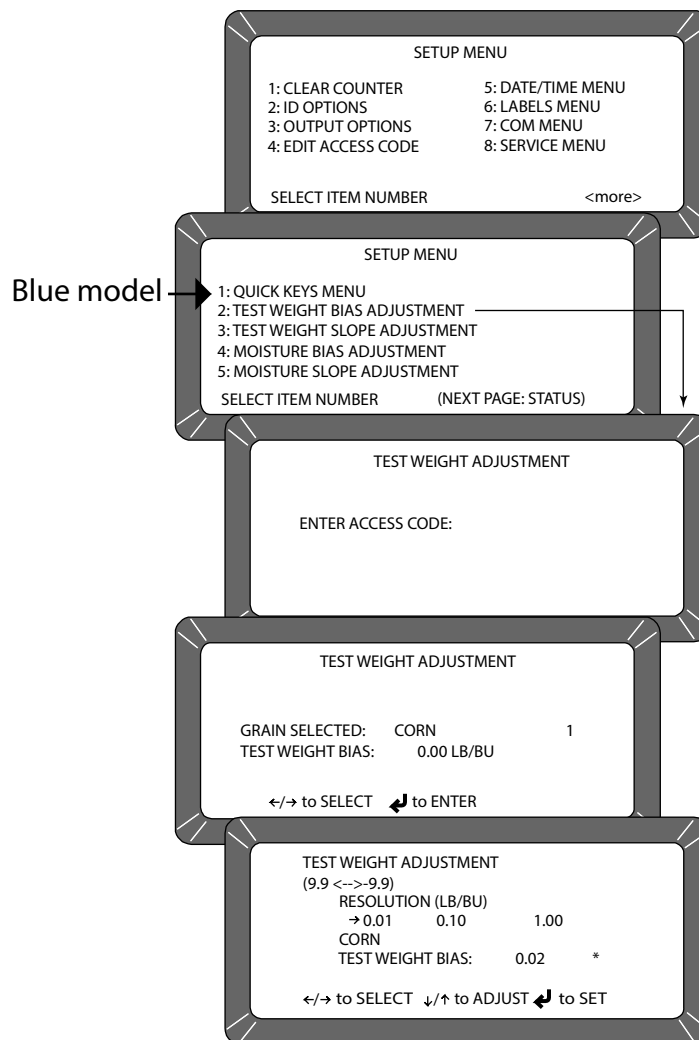



## TEST WEIGHT SLOPE ADJUSTMENT (SELECT MODELS ONLY)

Test weight slope adjustment allows entering a slope correction factor for differences between the GAC 2100 grain test weight slope and the official test weight slope reference. A slope value should only be changed by an authorized user.

**IMPORTANT: A slope value should only be changed by authorized personnel.**

### To Change the Test Weight Slope Adjustment:

1. Press the 4 key (Setup menu) from the Main Menu and then the **Next Page** key to access PAGE 2 of the Setup menu.
2. Press the 3 key (Blue model) or press the 2 key (AGRI and Gray models) to choose TEST WEIGHT SLOPE ADJUSTMENT.
3. Enter the Access code and press the **Enter** key.
4. At the Test Weight Adjustment screen, the selected grain and the slope with the current bias value displays.
5. Use the **Left/Right Arrow** keys to select the grain type for correction. The grain name and its number to the right change with each key stroke. Advance until the correct grain displays. If the end of the list is reached, the list will wrap around to the beginning and start again.
6. When the correct grain is found, press the **Enter** key. The Test Weight Adjustment screen displays the selected grain values. The adjustment consists of 4 numerical settings consisting of whole number, tens, hundreds, and thousands values.
7. Press the **Left/Right Arrow** keys to select the desired digit to change.
8. Change the selected value with the **Up/Down Arrow** keys. The value of the number changes on the TEST WEIGHT SLOPE line with each button press.
9. When finished, press the **Enter** key to accept the final bias value.
  - An asterisk appears next to the value to indicate the number is recorded and a test weight slope bias is applied.
10. Press the **Previous Page** key to return to the Setup menu.

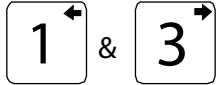

Left and Right Arrow Keys



Enter Key

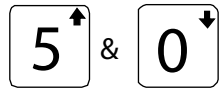

Up and Down Arrow Keys



Previous Page Key





Figure 50  
Test Weight Slope Adjustment

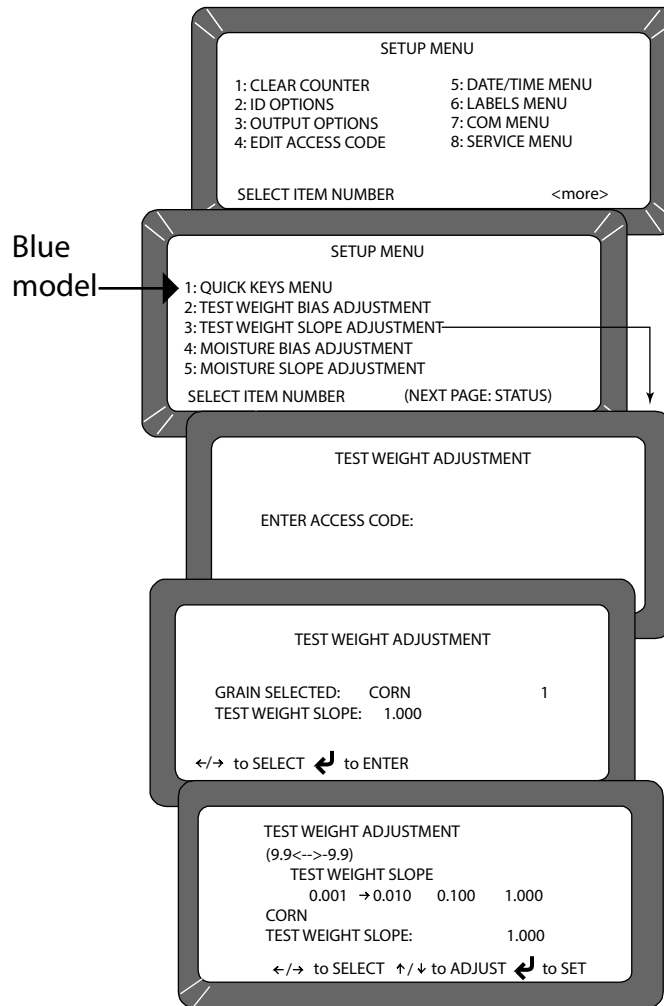

## MOISTURE BIAS ADJUSTMENT (SELECT MODELS ONLY)

Moisture bias adjustment allows entry of a correction factor for differences between the GAC 2100 grain moisture and the official moisture reference.

**IMPORTANT:** Pressing the security switch located internally on the circuit board is required to gain access to Moisture Bias and Moisture Slope Adjustment screens and should be performed by an authorized user.

### To Change the Moisture Bias Adjustment:

1. Press the 4 key (Setup menu) from the Main Menu and then the **Next Page** key to access PAGE 2 of the Setup menu.
2. Press the 4 key (Blue) or press the 3 key (AGRI and Gray models) to select MOISTURE BIAS ADJUSTMENT.
  - Proceeding screens are locked until manually pressing the security button located on the circuit board inside the instrument.



Next Page Key



## Locating the Instrument Security Button:

3. Locate the access port door located on the back of the instrument and remove seal, if necessary, from the door.
4. Remove screw to open access port door.
5. Press the white security button to advance to the next Moisture Bias Adjustment screen.

*Figure 51*

*Locate and Press Security Button*

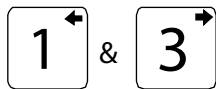
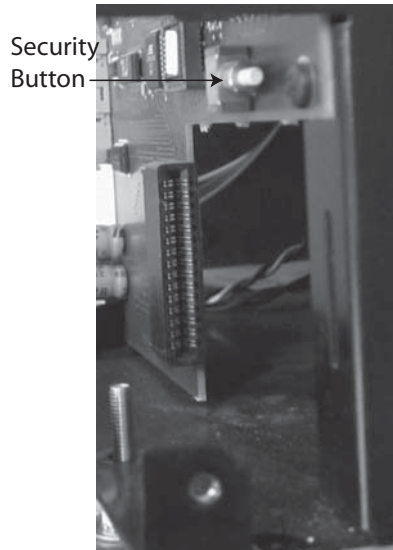

Left and Right Arrow Keys



Enter Key

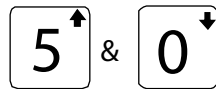

Up and Down Arrow Keys



Previous Page Key

6. At instrument display screen, use the **Left/Right Arrow** keys to select the grain type for correction. The grain name and its number to the right change with each key stroke. Advance until the correct grain displays. If the end of the list is reached, the list will wrap around to the beginning and start again.
7. When the correct grain is found, press the **Enter** key. The adjustment screen displays the selected grain values. The adjustment consists of 3 numerical settings consisting of whole number, tenths, and hundredths values.
8. Press the **Left/Right Arrow** keys to select the desired digit to change.
9. Change the selected value using the **Up/Down Arrow** keys. The value of the number changes on the MOISTURE BIAS line with each button press.
10. When finished, press the **Enter** key to accept the final bias value.
  - When a grain measurement is taken, an asterisk appears in front of the moisture value and reflects a moisture bias is enabled. All changes are recorded in the Audit Trail.
11. Press the **Previous Page** key to return to the Setup menu.



Figure 52  
Moisture Bias Adjustment

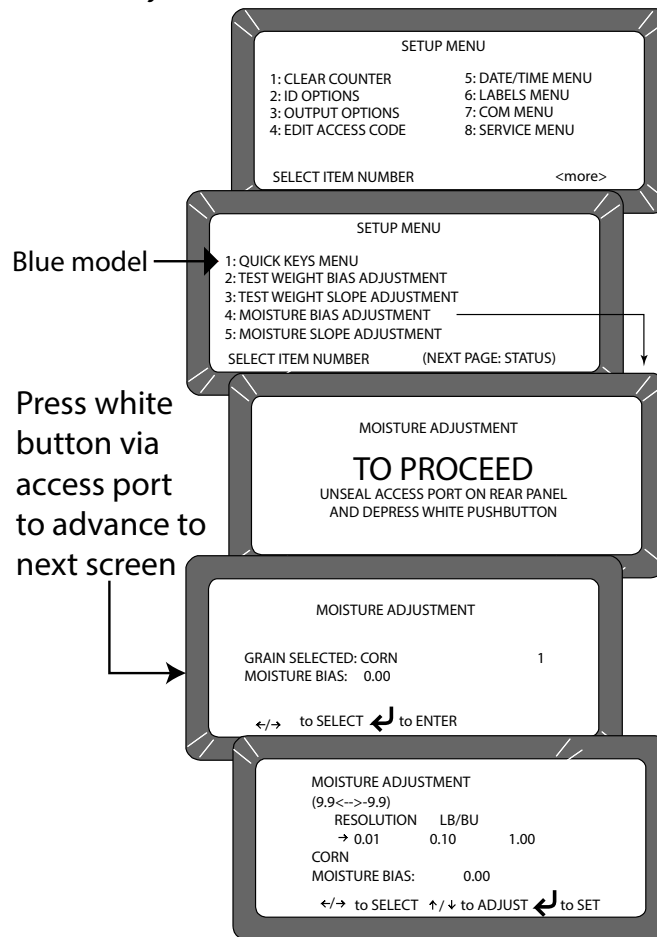

## MOISTURE SLOPE ADJUSTMENT (SELECT MODELS ONLY)

Moisture slope adjustment allows entry of a slope correction factor for differences between the GAC 2100 grain moisture and the official moisture reference.



Next Page Key

**IMPORTANT: A slope value should only be changed by an authorized user.**

### To Change the Moisture Slope Adjustment:

1. Press the 4 key (Setup menu) from the Main Menu and then the **Next Page** key to access PAGE 2 of the Setup menu.
2. Press the 5 key (Blue model) to select MOISTURE SLOPE ADJUSTMENT or press the 4 key (AGRI and Gray models).
  - Proceeding screens are locked until manually pressing the security button located on the circuit board inside the instrument.

### Locating the Instrument Security Button:

3. Locate the access port door located on the back of the instrument and remove seal, if necessary, from the door.

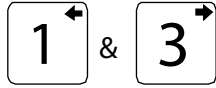

Left/Right Arrow Keys



Next Page Key

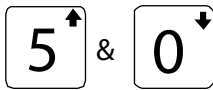

Up/Down Arrow Keys



Previous Page key

4. Remove screw to open access port door.
5. Press the white security button to advance to the next Slope Bias Adjustment screen.
6. At the display screen, use the **Left/Right Arrow** keys to select the grain type for correction. The grain name and its number to the right change with each key stroke. Advance until the correct grain displays. If the end of the list is reached, the list will wrap around to the beginning and start again.
7. When the correct grain is found, press the **Enter** key. The Adjustment screen displays the selected grain values. The adjustment consists of 4 numerical settings consisting of whole number, tens, hundreds, and thousands values.
8. Press the **Left/Right Arrow** keys to select the desired digit to change.
9. Change the selected value with the **Up/Down Arrow** keys. The value of the number changes on the MOISTURE SLOPE line with each button press.
10. When finished, press the **Enter** key to accept the final bias value. An asterisk appears next to the value to indicate the number is recorded and a moisture slope bias is applied.
11. Press the **Previous Page** key to return to the Setup menu.

*Figure 53*  
*Slope Bias Adjustment*

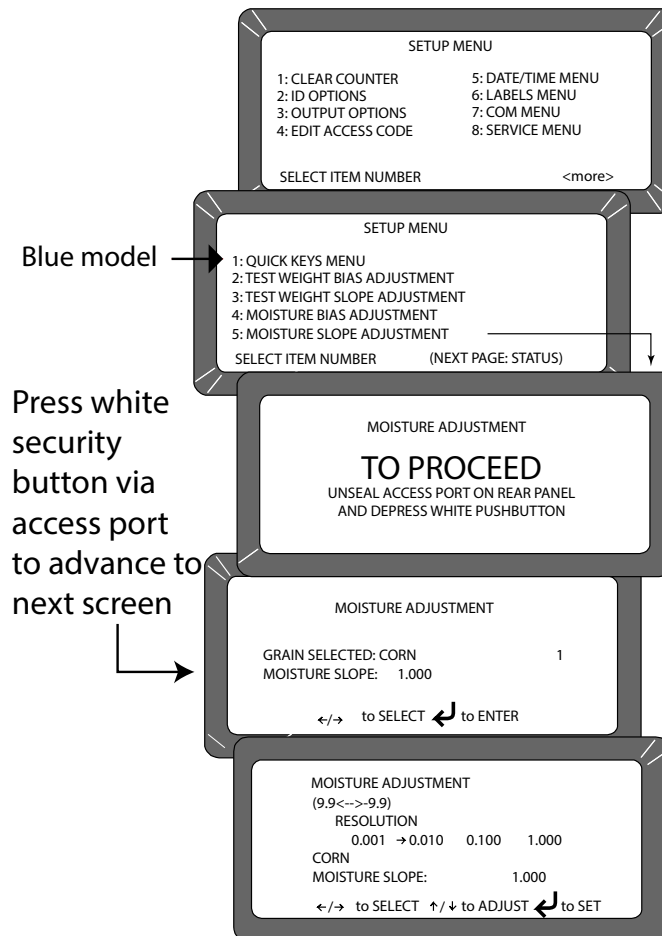

# OPERATOR'S MANUAL

---





## TEST UNIT PERFORMANCE

The **Tests** menu displays diagnostic tests and status information for operating values. The information is useful to technicians in evaluating overall performance and isolating problems. During normal operation, these are not generally referenced. However, problem identification can be assisted by reviewing certain values occasionally and observing changes. Most values cannot be edited, but the contents can be printed for record retention. Also, while viewing the Factory Modes, earlier encountered errors stored in memory may be printed.

To access the **Tests** menu, select the 5 Key on the **Main** menu. The **Tests** menu displays eight choices ([Figure 54](#)).

### NON-ACTIVE KEYS

The 1 and 4 key selections are non-active and have no functions assigned. Selecting either key will only result in an audible beep.

*Figure 54*

#### *Entering The Tests Menu*

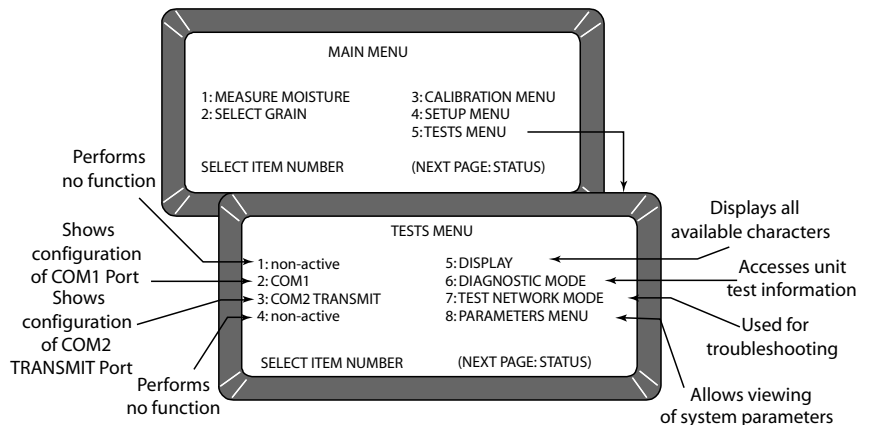

### VIEW COM1 PORT (2 KEY)

The **COM1 Test** screen displays the configuration of the COM1 (communications) port. Values are set from the SETUP MODE to match the driving device (i.e. printer) of the port.

#### To Access the COM1 Port:

1. Access the **COM1** Menu by selecting the 2 key on the **Tests** menu ([Figure 55](#)). The **COM1 Test** screen displays the COM1 serial data setup status (Baud Rate, Data Bits, Parity, Stop Bits) on the left half of the screen. The COM1 control lead setup status displays on the right side showing the Buffer Status. The buffer line indicates either BUSY or EMPTY.



Previous Page Key

2. Verify that a printer is connected and select the **Print** key to print a sample of the entire TRANSMIT CHARACTER SET. When completed, select the **Previous Page** key to return to the **Tests** menu.

Figure 55

### Entering The COM1 Test Menu

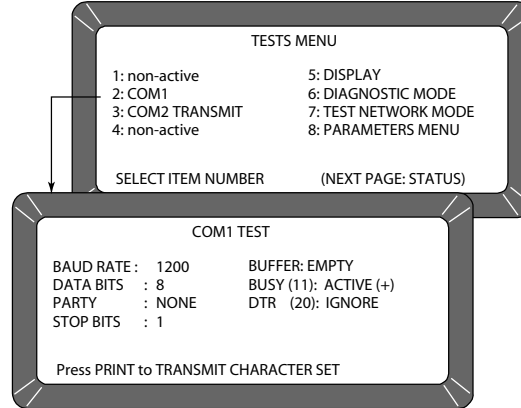

## VIEW COM2 TRANSMIT PORT (3 KEY)

The **COM2 Transmit Test** screen displays the configuration of the COM2 TRANSMIT port. Values are set from the SETUP MODE to match the communicating device (i.e. computer) of the port.

### To Configure the COM2 TRANSMIT Port:

1. From the **Tests** menu, select COM2 TRANSMIT TEST using the 3 key (**NOTE:**). The screen displays the COM2 Mode, Serial Data Setup (Baud Rate, Data Bits, Parity, Stop Bits), Buffer Status and the COM2 Control Lead Setup. If the buffer contains information, the line will indicate BUSY; otherwise EMPTY is indicated.
  - Press the **Print** key to produce a printout of the character set through the COM2 port.
  - Press the **Previous Page** key to return to the **Tests** menu.



Print Key



Previous Page Key

**NOTE:** COM2 data setup protocols are fixed at Baud Rate 115200, Data Bits at 8, Parity at None, and Stop Bits at 1 although the settings menu may show other values.

Figure 56

### Entering the COM2 Transmit Test Menu

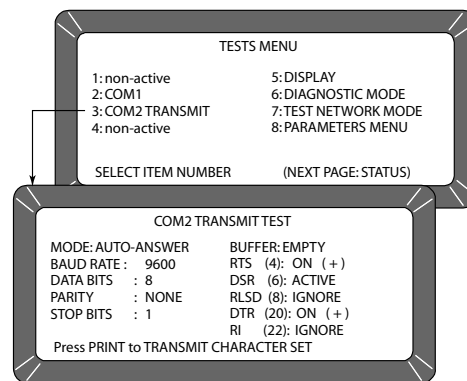



## VIEW DISPLAY CHARACTERS (5 KEY)

The display screen indicates typical characters the instrument is capable of producing for operator-generated messages (Figure 57).



Previous Page Key

### To Access Characters:

1. From the **Test** menu, select the 5 key to choose DISPLAY. The screen shows characters, symbols, and digits that can display by the unit.
2. After viewing, select the **Previous Page** key to return to the **Tests** Menu.

Figure 57

### Display Mode Screen

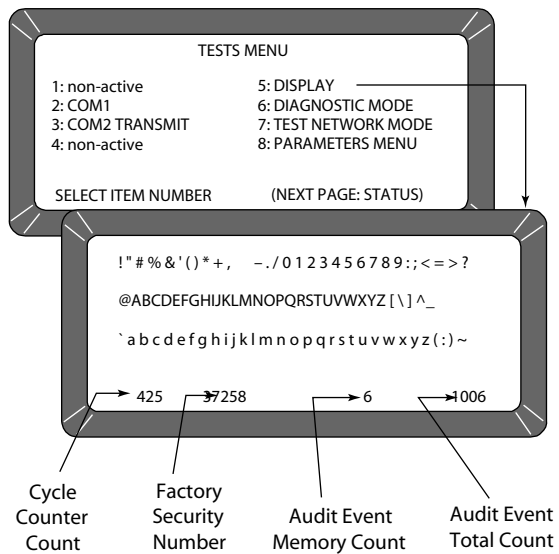





## VIEW DIAGNOSTIC MODE (6 KEY)

The Diagnostic Mode accesses unit operating values. Most of the readout values relate to the test cell circuitry.

### To Access Diagnostic Details:

1. Press the 6 key to enter DIAGNOSTIC MODE (PAGE 1). Two pages of information are available (Figure 58).
2. Choose the number key next to each selection, one key at a time. Each value calculates and is displayed next to the line title. If the printer is connected, a printout of each result is automatically printed (Figure 59) for PAGE 1 printout and (Figure 60) for PAGE 2 printout). The meaning of each line is as follows:
  - 1: **Vnull** - Null voltage from cell board.
  - 2: **Vtemp** - Temperature diode voltage from cell board.
  - 3: **Cwgt** - Counts from weight oscillator.
  - 4: **Ce/f** - Ratio of empty cell weight oscillator counts to full cell weight oscillator counts. When the 4 key is selected, item 3 blanks to recalculate. The message PLEASE WAIT followed by PLACE WEIGHT ON CELL THEN PRESS ENTER displays. A test weight is placed on top of the test cell and then the **Enter** key is selected. After a short wait, the results will display.
  - 5: **SCD1** - D1 (conductivity) self-check -  $379 \pm 20$ . When either the 5 or 6 key is selected, these two items calculate.
  - 6: **SCD2** - D2 (capacitance) self-check-  $2500 \pm 20$ .
  - 7: **Temp** - Computed cell temperature in degrees C.

Figure 58

### Diagnostic Mode Screens

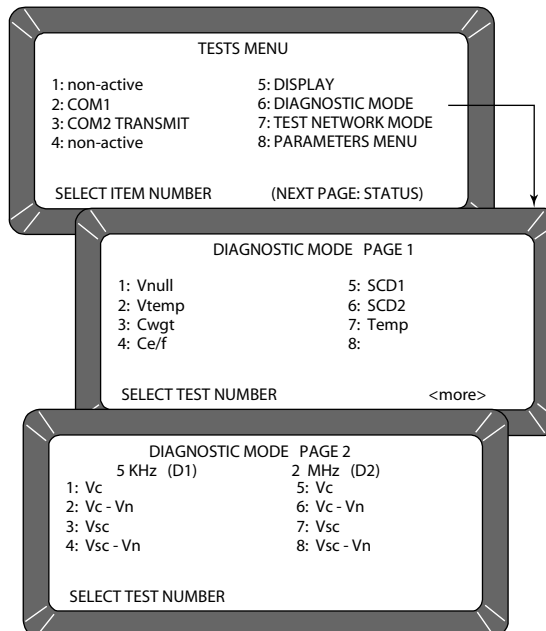



Next Page key



Previous Page Key

3. Press the **Next Page** key to view PAGE 2 of the DIAGNOSTIC MODE. The display screen is divided into two columns: 5 kHz and 2 MHz (Figure 58).
  - **5 kHz (D1) – Left half of screen**
    - 1: **Vc** - Voltage of 5 kHz oscillator.
    - 2: **Vc-Vn** - Voltage of 5 kHz oscillator minus null voltage.
    - 3: **Vsc** - Voltage of 5 kHz oscillator with on-board test network engaged.
    - 4: **Vsc - Vn** - Voltage of 5 kHz oscillator with the on-board test network engaged minus null voltage.
  - **2 MHz (D2) – Right half of screen**
    - 5: **Vc** - Voltage of 2 MHz oscillator.
    - 6: **Vc - Vn** - Voltage of 2 MHz oscillator minus null voltage.
    - 7: **Vsc** - Voltage of 2 MHz oscillator with on-board test network engaged.
    - 8: **Vsc - Vn** - Voltage of 2 MHz oscillator with on-board test network engaged minus null voltage.
4. When finished, press the **Previous Page** key twice to return to the **Tests** menu.

*Figure 59*

*Diagnostic Mode Printout of Page 1*

VNULL:	0,0496
VTEMP:	1,1838
CWGT:	38908
CE/F:	1,05377
S/N:	0261-2360
SCD1:	378
SCD2:	2499
NEC:	0,04941
KEC:	1,50218
KSC:	1,22889
MEC:	1,40597
MSC:	0,43373
TEMP:	18,26

*Figure 60*

*Diagnostic Mode Printout of Page 2*

5 KHZ VC:	1,5024
5 KHZ VC-VN:	1,4528
5 KHZ VSC:	1,2291
5 KHZ VSC-VN:	1,1795
2 MHZ VC:	1,4943
2 MHZ VC-VN:	1,4446
2 MHZ VSC:	0,4416
2 MHZ VSC-VN:	0,3920



## TEST NETWORK MODE (7 KEY)

This mode is used by trained, authorized personnel in troubleshooting. The screens and printout are shown for reference only.

### To Access the TEST NETWORK:

1. Press the 7 key - TEST NETWORK MODE (Figure 61). The **Please Wait** screen appears followed by the **Press Load To Begin** screen.
2. Press the **Load** key to start the measuring cycle. When the test is complete, the results display and print automatically if a printer is connected (Figure 62).



Load Key

Figure 61

### Displaying Test Network Mode Results

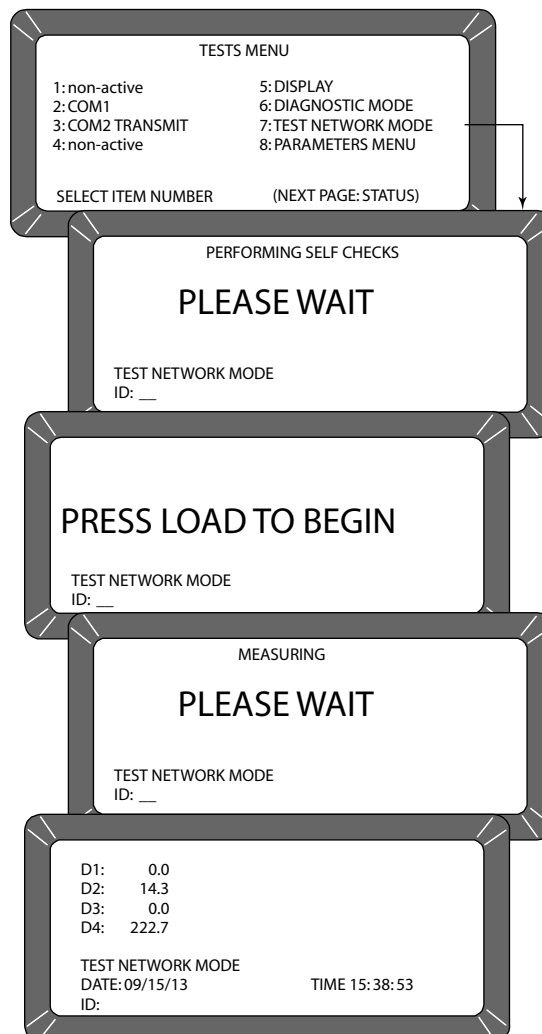



Figure 62

Test Mode Printout

DICKY-JOHN, CORP.GAC2100	
05/18/13	09:18:59
ID:	
NF:	490
NE:	490
D1:	0,0
D1CF:	15000
D1CE:	15000
D2:	14,4
D2CF:	14853
D2CE:	14853
D3:	0,0
D4:	204,3
D4TF:	20,43
D4TE:	20,39
SELECT TEST NUMBER	

## VIEW/PRINT PARAMETERS (8 KEY)

The **Parameters** menu (8 key) operates similarly to the **Service** menu located under the **Setup** menu. The major difference is the inability to edit values in these screens. However, the **View Factory Mode** screen is useful in viewing the number of currently stored errors in memory.

### To View the Parameters Menu:

1. At the Main menu, press the 5 key.
1. Press the 8 key from the Tests menu and press the **Parameters** menu. This menu displays the unit parameters.
2. To print the values shown on the screen, select any menu followed by the **Print** key. A printout of all the screens results (Figure 64). Item 6 also prints all stored errors.
3. When finished viewing the screens, select the **Previous Page** key to return to the **Tests** menu.



Print Key



Previous Page Key



*Figure 63*  
*Viewing Parameters Menu*

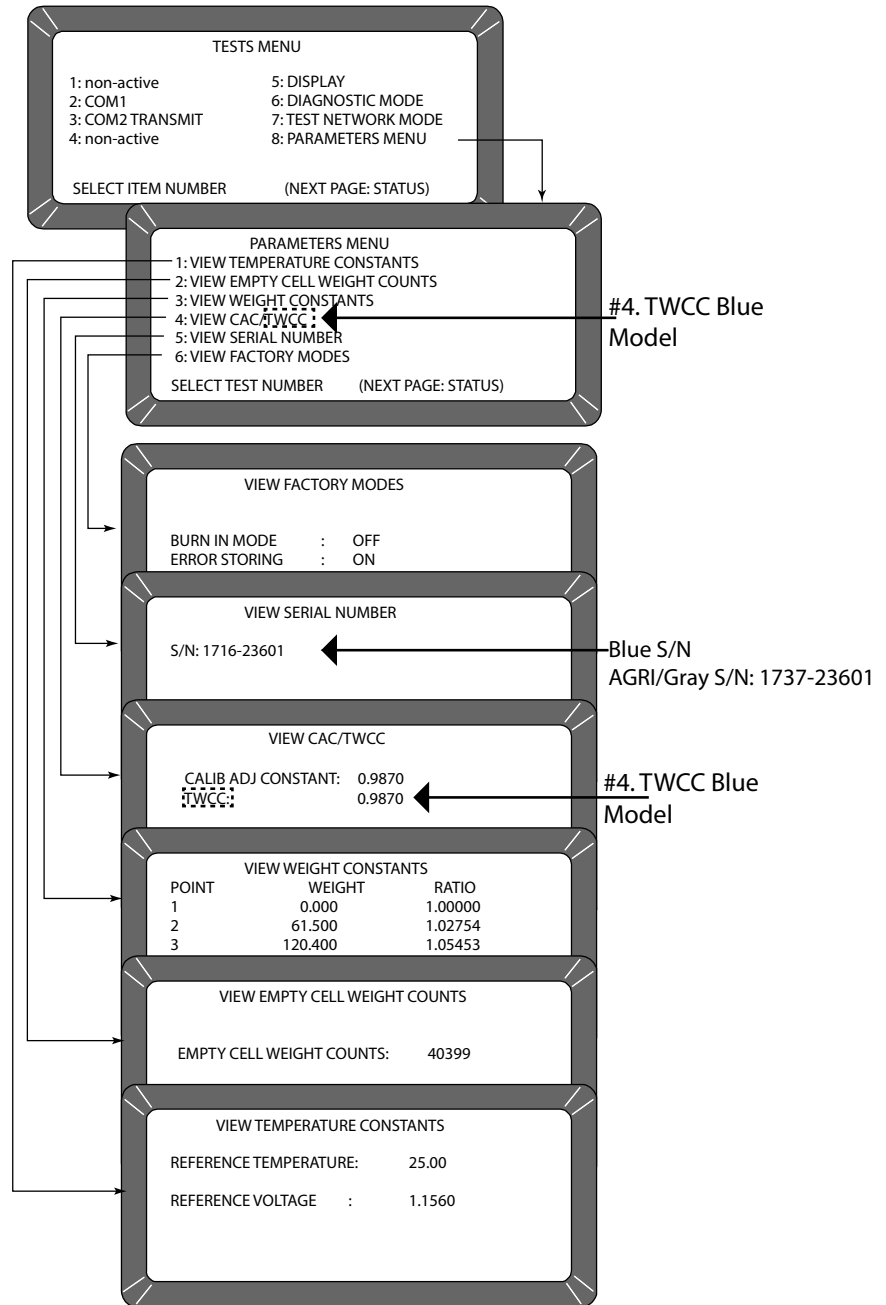



*Figure 64*

*Parameters Value Printout*

---

```
05/18/16          09:59:59
S/N:      1716-23601
REF TEMP:      25,00
REF VOLT:      1,1560
EC COUNT:      40399
WEIGHT TABLE:
1   0,000      1,00000
2  61,500      1,02754
3 120,400      1,05453
4 181,800      1,08340
5 240,600      1,11179
6 300,300      1,14108
CAC:      1,0000
IC:      1122
BURN IN MODE:  OFF
ERROR STORING: ON
CURRENT ERRORS
=====
ERROR 2
05/04/16 18:42:2
05/17/16 16:50:4
  5
50134
SELECT TEST NUMBER
```

# OPERATOR'S MANUAL

---





## OPERATOR MAINTENANCE



Load Key



Unload Key



Previous Page Key

### CELL CLEANING - DAILY

1. From the **Main** menu, select the 5-key to display the **Tests** menu. Then select the 6-key to display the **Diagnostics** menu.
2. When the **Diagnostics** menu displays select the **Load** key. The hopper doors open and remain open until the **Unload** key is selected.
3. Use the brush supplied in the accessory kit to clean the inside of the grain cell.
4. Slide the GAC 2100 to the front of the worktable and remove the grain drawer. Reach inside and very carefully clean the strike-off arm spring.

### **CAUTION**

Before performing step 5 ensure that all fingers or other foreign objects are not in cell area.

5. Press the **Unload** key. The cell will rotate 180 degrees to dump the residue from the cell cleaning procedure. The hopper doors will close.
6. Press the **Previous Page** key twice to return to the **Main** menu.

### FUSE REPLACEMENT

1. Disconnect the line cord from the rear of the unit.
2. Use a small-bladed screwdriver or similar tool to remove the cover and fuse block assembly.
3. Replace the blown fuse with a 1 Amp Slo-Blo fuse (Fuse Size = 5mm (0.197") dia. x 20 mm (0.787") long).
4. Reinstall fuse block assembly and cover.

Figure 65

Fuse Block Assembly

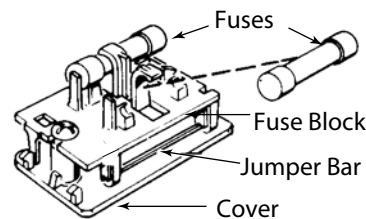

### **CAUTION**

1 A Max fuses. Voltage rating 110/220V, 50/60 Hz





## ERROR CODES

The GAC 2100 contains a microprocessor to control the grain sample measurements and self-checks to determine the integrity of the internal electronics. If any limit is exceeded or malfunctions occur, an error code displays.

<b>Error</b>	<b>Probable Cause</b>	<b>Corrective Action</b>
1	The empty cell self-check reading is out of limits.	Dump the cell and verify it is empty.
2	The empty cell weight reading is out of limits.	Dump the cell and verify it is empty.
3	The unload mechanism has malfunctioned.	Check the cell position and verify it is free to operate.
4	The strike-off mechanism has malfunctioned.	Check drawer and press the Unload key. Verify the cell and strike-off arm are free to operate.
5	An invalid calibration is referenced.	Reselect the same grain or select a new grain and retry. If the condition continues to occur, contact a DICKEY-john representative for assistance.
6	The moisture reading exceeds the upper limit.	Select a new grain and retry.
7	The moisture reading exceeds the lower limit.	Select a new grain and retry.
8	The empty cell ambient temperature has exceeded its limit.	Allow the GAC 2100 to reach normal operating temperature.
9	The sample temperature exceeds its limit.	Allow the sample to either cool down or warm up, then retry.
10	The difference in temperature between empty cell ambient and full cell condition exceeds its limits.	Change the appropriate conditions and retry.
11	Test weight exceeds stored average bulk density value by more than +20 percent or -30 percent.	Use a more representative sample.
12	A system memory error occurred.	Turn the power OFF for at least 5 seconds; power system ON. If the condition continues, contact a DICKEY-john representative.
13	An onboard RAM memory error has occurred.	Turn the power OFF for at least 5 seconds; turn power system ON. If the condition continues, contact a DICKEY-john representative for assistance.
14	NOT USED	
15	The real-time clock battery is faulty.	Contact a DICKEY-john representative for assistance.



## APPENDIX A: COMMUNICATION PORTS

### COM1 PORT OPTIONS

*NOTE: COM 1 port requires a standard DTE/DCE RS 232 cable without a null modem when connecting to a printer or computer.*

The COM1 Port (refer to Table 2) is a serial port conforming to the EIA/TIA RS-232-E standard and configured as Data Communication Equipment (DCE). Data out is RS-232-E levels and parity with adjustable Format, Data Setup and Control.

Function	Option	Hex
Output Format	PRN 20 PRN 80 TST 20 PRN 81 CSV 01 PRN 21	
Line Terminator	LF (Line Feed) CR (Carriage Return) LF + CR CR + LF	0A 0D 0A, 0D 0D, 0A
Data Setup Baud Rate	300 600 1200 2400 4800 9600 19200	
Control Busy	Ignore Active (+) Active (⊘)	
Control DTR	Ignore Active	

### COM1 PIN ASSIGNMENT DETAILS

COM1 (refer to Table 3) is configured as Data Communication Equipment (DCE).

**Protective Ground (pin 1)** – Electrically connected to frame.

**Received Data (pin 3)** – Transmitted data from the GAC 2100.

**Data Set Ready (pin 6)** – ON (positive voltage) whenever the GAC 2100 is powered.

**Signal Ground (pin 7)** – Common reference for all other COM1 signals.

**Received Line Signal Detector (pin 8)** – ON (positive voltage) whenever the GAC 2100 is powered.

**Busy (pin 11)** – Gates the transmission of data from the GAC 2100. The **COM1 Control Lead Setup** screen may be configured ACTIVE (+), ACTIVE (–) or IGNORE. When the line is inactive, up to 2048 characters are buffered. If not connected, configure this line as IGNORE.



**Data Terminal Ready (pin 20)** – Indicates the connected device is not available. The **COM1 Control Lead Setup** screen configures this line as ACTIVE or IGNORE. If configured ACTIVE, an OFF condition (negative or zero voltage) inhibits the transmission of data from the GAC 2100. Results display but are not buffered for output on COM1. If not connected, this line should be configured as IGNORE.

Pin Number	Designation	Signal Name	Direction
1	AA	Protective Ground	NA
3	BB (RxD)	Received Data	To Device
6	CC (DSR)	Data Set Ready	To Device
7	AB	Signal Ground	NA
8	CF (RLSD)	Received Line	To Device
11		Signal Detector Busy	To GAC 2100
20	CD (DTR)	Data Terminal Ready	To GAC 2100

Function	Option	Hex
Output Format	PRN 20 PRN 80 TST 20 PRN 81 CSV 01 PRN 21	
Line Terminator	LF (Line Feed) CR (Carriage Return) LF + CR CR + LF	0A 0D 0A, 0D 0D, 0A
Data Setup Baud Rate	300 600 1200 2400 4800 9600 19200	
Data Bits Parity Stop Bits	7 or 8 None, Even or Odd 1 or 2	
Control MODE	Transmit Only Auto Answer	
Control RTS	On (+) Auto	
Control DSR	Ignore Active	

*NOTE: COM 2 Baud Rate will always remain at 115200, Data Bits at 8, Parity at None, and Stop Bits at 1 although the option to change are in the manual.*

*COM 2 requires an RS 232 null modem when connecting to a computer or printer.*

## COM2 PIN ASSIGNMENT DETAILS

COM2 (refer to Table 5) is configured as Data Terminal Equipment (DTE).

**Protective Ground (pin 1)** – Electrically connected to frame.

**Transmitted Data (pin 2)** – Data is transmitted from this pin.

**Received Data (pin 3)** – Data is received on this pin.



**Request To Send (pin 4)** – Configured ON (positive voltage) whenever unit is powered or to be ON (positive voltage) only when there is data in the COM2 buffer to be transmitted. Use the **COM2 Control Lead Setup** screen to configure this line.

**Clear To Send (pin 5)** – Gates transmission of data from the GAC 2100. This line must be ON (positive voltage) to obtain data on COM2. If an appropriate signal is not available from the connected device, connect this pin directly to REQUEST TO SEND (pin 4). When the line is inactive, up to 2048 characters are buffered.

**Data Set Ready (pin 6)** – Notifies the GAC 2100 that the connected device is not available. The **COM2 Control Lead Setup** screen configures this line as active or ignored. If configured as ACTIVE, an OFF condition (negative or zero voltage) inhibits the transmission of data from the GAC 2100. Results display but are not buffered for output on COM2. If not connected, this line should be configured as IGNORED.

**Signal Ground (pin 7)** – Common ground reference for all other COM2 signals.

**Received Line Signal Detector (pin 8)** – Currently not used.

**Data Terminal Ready (pin 20)** – ON (positive voltage) whenever the GAC 2100 is powered.

**Ring Indicator (pin 22)** – Currently not used.

Pin Number	Designation	Signal Name	Direction
1	AA	Protective Ground	NA
2	BA (TxD)	Transmitted Data	To Device
3	BB (RxD)	Received Data	To GAC 2100
4	CA (RTS)	Request To Send	To Device
5	CB (CTS)	Clear To Send	To GAC 2100
6	CC (DSR)	Data Set Ready	To GAC 2100
7	AB	Signal Ground	NA
8	CF (RLSD)	Received Line to Signal Detector	To GAC 2100
20	CD (DTR)	Data Terminal Ready	To Device
22	CE (RI)	Ring Indicator	To GAC 2100



# GAC<sup>®</sup> 2100 GRAIN ANALYSIS COMPUTER

MODELS GAC 2100 BLUE,  
GAC 2100 AGRI,  
GAC 2100 GRAY

## DICKEY-john Sales

800-637-2952

agsales@dickey-john.com

## DICKEY-john Technical Support

800-637-3302

service@dickey-john.com

## Europe Sales and Technical Support

+33 1 41 19 21 80

europe@dickey-john.com

